

STATE OF MAINE DEPARTMENT OF TRANSPORTATION



DEXTER PENOBSCOT ROUTE 7

FEDERAL AID PROJECT STP-1824(600)
PROJECT LENGTH : 1.64 MILES

PLAN LEGEND

Town, County, State	Centerline-Existing	Centerline-Proposed
Property Lines	Travelway-Existing	Travelway-Proposed
R/W Lines-Existing	Railroad	Catch Basins
R/W Lines-Proposed	Culvert-Existing	Manholes
Culvert-Proposed	Culvert-Proposed	Proposed Underdrain
Curbing	Existing	Proposed
Type 1	Type 3	Type 5
Outline of Bodies of Water	Ledge	Buildings
Trees	Tree Line	Clearing Limit Line
Conifer	Deciduous	
Existing Water Line	Existing San. Sewer	Existing San. Sewer Manhole
Guardrail-Existing	Guardrail-Proposed	Guardrail-Cable, Other
Existing Ditch	Proposed Ditch	Existing Ditch
Utility Poles	Existing	Proposed
Fire Hydrants	Existing	Proposed

INDEX OF SHEETS

Description	Sheet No.
Title Sheet	1
Typical Sections	2
Estimated Quantities	3
Drainage Sheet	4
Construction Notes	5
Plan / Profile	7-33
Geometric Curb Layout	X
Cross - Sections	34-141
Right of Way Map	X

SAMPLE PLAN SET

MILESTONE: HORIZONTAL/VERTICAL ALIGNMENT COMPLETE

THIS SAMPLE PLAN SET REPRESENTS A TYPICAL URBAN, FULL RECONSTRUCTION PROJECT PLAN SET AT THE LEVEL OF DETAIL EXPECTED AT THIS MILESTONE.

IT IS INTENDED TO PROVIDE GUIDANCE IN WHAT LEVEL OF DETAIL AND WHAT TYPE OF INFORMATION IS REQUIRED AT THIS MILESTONE.
IT IS NOT INTENDED THAT EACH SET OF PLANS LOOK EXACTLY LIKE THIS ONE.

NOTE:

THE TYPICAL SECTIONS AND THE CROSS SECTIONS SHOW A VERTICAL LINE AT THE BREAK BETWEEN 2% AND 4%. AS LONG AS THE TYPICAL SECTIONS ARE CLEARLY LABELED, THIS LINE COULD BE LOCATED AS SHOWN, AT THE EDGE OF TRAVELWAY OFFSET, OR NOT AT ALL. IT IS IMPORTANT TO REMEMBER THAT THE TRAVELWAY WIDTH IS DEFINED BY THE STRIPE LOCATION - THEREFORE IF THE SHOULDER BREAK IS AT A DIFFERENT OFFSET THAN THE EDGE OF TRAVELWAY, THE LINE DISPLAYED IN PLANVIEW SHOULD BE AT THE EDGE OF TRAVELWAY.

TRAFFIC DATA

	Route 7 0.13 mile SE/O Fay Ct	Route 7/23 NE/O Route 23
Current (2015) AADT	7980	5230
Future (2035) AADT	9580	6280
DHV - % of AADT	10	10
Design Hour Volume	958	628
% Heavy Trucks (AADT)	8	7
% Heavy Trucks (DHV)	8	7
Directional Distribution (DHV)	54	51
18 kip Equivalent P 2.0	370	315
18 kip Equivalent P 2.5	352	300
Design Speed (mph)	25	25
Functional Class:	minor arterial	minor arterial

LAYOUT SCALE

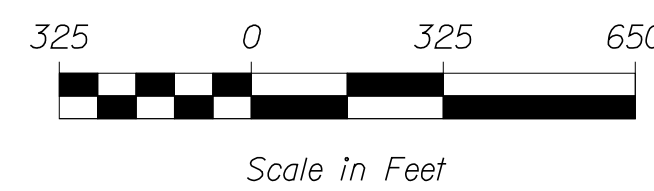

PROJECT LOCATION:	BEGINNING 0.10 OF A MILE NORTHERLY OF MECHANIC STREET AND EXTENDING NORTHERLY 1.64 MILES
PROGRAM AREA:	HIGHWAY
SCOPE OF WORK:	RECONSTRUCTION AND MILL & FILL

WIN 18246.00 018246.00

DEXTER
ROUTE 7
TITLE SHEET

SHEET NUMBER
1
OF 15

STATE OF MAINE	DEPARTMENT OF TRANSPORTATION	APPROVED	DATE
		COMMISSIONER:	CHIEF ENGINEER:

SIGNATURE	P.E. NUMBER	DATE
-----------	-------------	------

PROGRAM	PROJECT MANAGER	DESIGNER	CONSULTANT	PROJECT RESIDENT	CONTRACTOR	PROJECT COMPLETION DATE
---------	-----------------	----------	------------	------------------	------------	-------------------------

Date: 12/10/2013

Username: atlee.mousseau

Division: HIGHWAY

Filename: ... \002_Typical.dgn

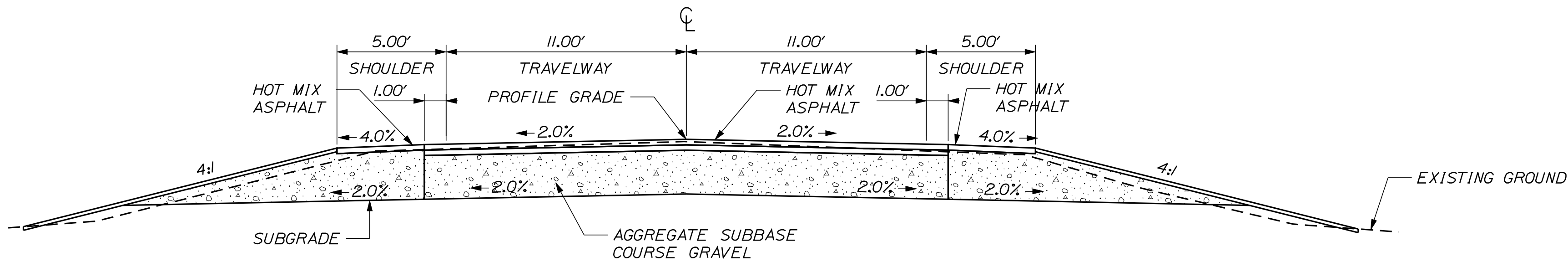

FULL CONSTRUCTION OPEN

AGGREGATE SUBBASE COURSE GRAVEL		
LEFT SHOULDER	11 FT. TRAVEL LANES	RIGHT SHOULDER
STATION TO STATION	STATION TO STATION	STATION TO STATION

NOTE:

1. THE PAVEMENT, BASE AND SUBBASE DEPTHS AS SHOWN ON THE PLANS ARE INTENDED TO BE NOMINAL.
2. WHEN SUPERELEVATION EXCEEDS THE SLOPE OF THE LOW SIDE SHOULDER, THE LOW SIDE SHOULDER SHALL HAVE THE SAME SLOPE AS THE TRAVELWAY.
3. CROWNS FOR BOTH NORMAL AND SUPERELEVATION SECTIONS FOR ALL COURSES OF SUBBASE AND PAVEMENT SHALL BE STRAIGHT.
4. THE GRAVEL QUANTITY CALCULATION IS BASED ON A 2" LOAM OR DIRTY BORROW DEPTH. THE ACTUAL DEPTH MAY VARY. SEE THE GENERAL NOTES.
5. THE ALGEBRAIC DIFFERENCE BETWEEN THE SHOULDER AND TRAVELWAY CROSS SLOPES "ROLLOVER" SHALL NOT EXCEED 8%.
6. THE STATIONING SHOWN UNDER EACH TYPICAL IS APPROXIMATE.

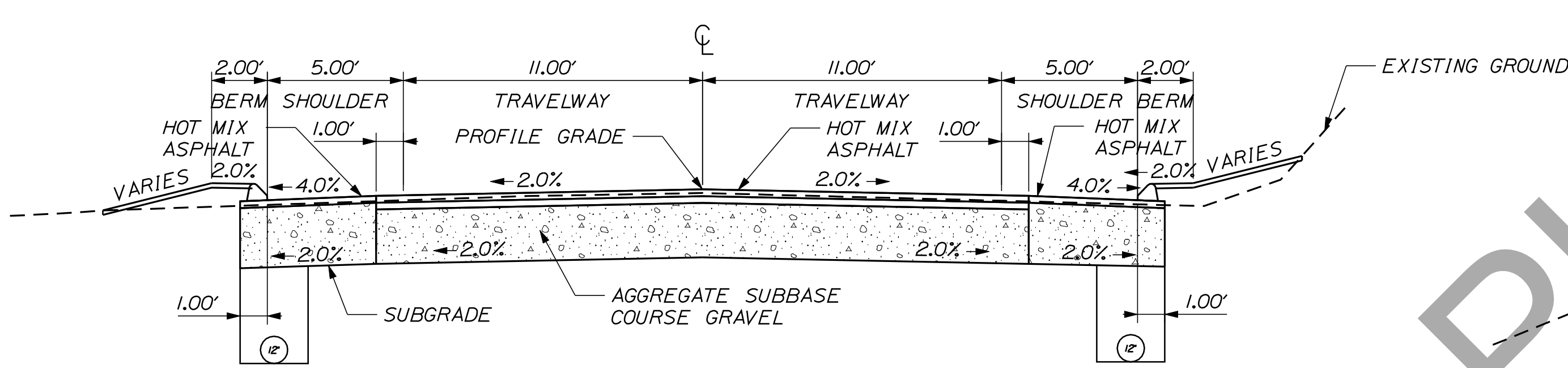

FULL CONSTRUCTION

AGGREGATE SUBBASE COURSE GRAVEL		
LEFT SHOULDER	11 FT. TRAVEL LANES	RIGHT SHOULDER
STATION TO STATION	STATION TO STATION	STATION TO STATION

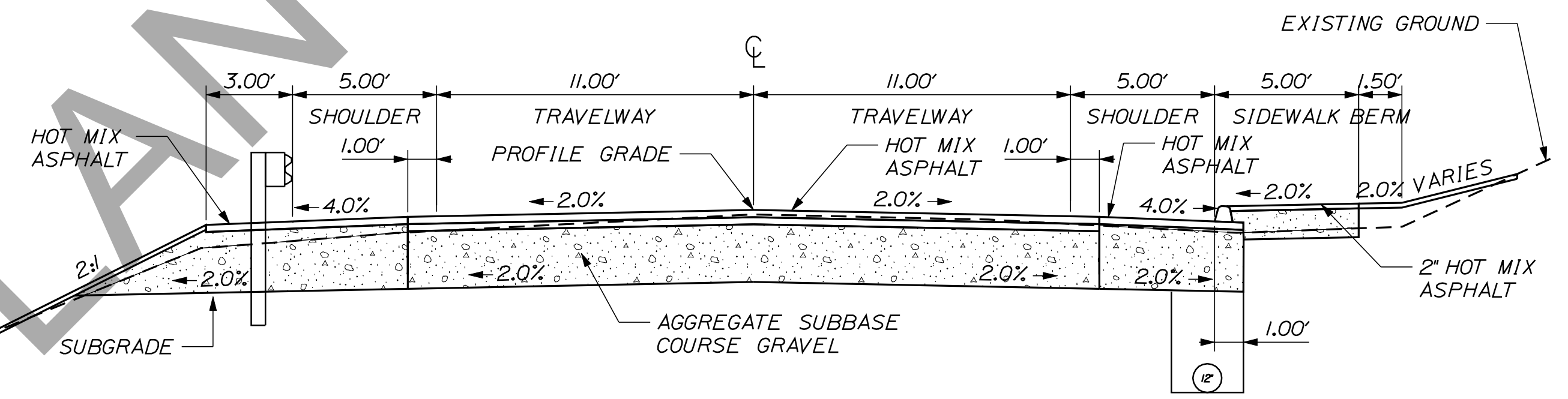

FULL CONSTRUCTION GUARDRAIL LEFT

AGGREGATE SUBBASE COURSE GRAVEL		
LEFT SHOULDER	11 FT. TRAVEL LANES	RIGHT SHOULDER
STATION TO STATION	STATION TO STATION	STATION TO STATION

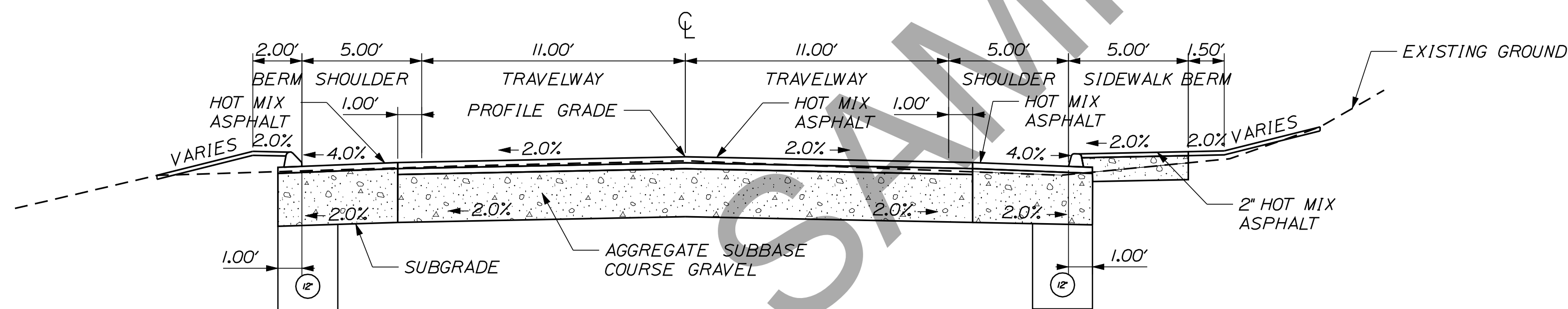

FULL CONSTRUCTION W/SIDEWALK

AGGREGATE SUBBASE COURSE GRAVEL		
LEFT SHOULDER	11 FT. TRAVEL LANES	RIGHT SHOULDER
STATION TO STATION	STATION TO STATION	STATION TO STATION

LT. SHOULDER	LT TRAVELWAY	STATION	RT TRAVELWAY	RT. SHOULDER
MATCH	MATCH	11+50	MATCH	MATCH
-4	-2	12+50	-2	-4
-4	-2	87+00	-2	-4
MATCH	MATCH	87+50	MATCH	MATCH
		END		

STATE OF MAINE
DEPARTMENT OF TRANSPORTATION

018246.00

WIN
18246.00

HIGHWAY PLANS

SIGNATURE

DATE

BY
ERNEST MARTIN

DESIGN-REVIEWED
TRAVIS WOLET

DESIGN-DETAILED

DESIGN-DETAILED

REVISIONS 1

REVISIONS 2

REVISIONS 3

REVISIONS 4

FIELD CHANGES

P.E. NUMBER

DATE

DEXTER
ROUTE 7

TYPICAL SECTIONS

SHEET NUMBER

2

OF 141

NOT TO SCALE

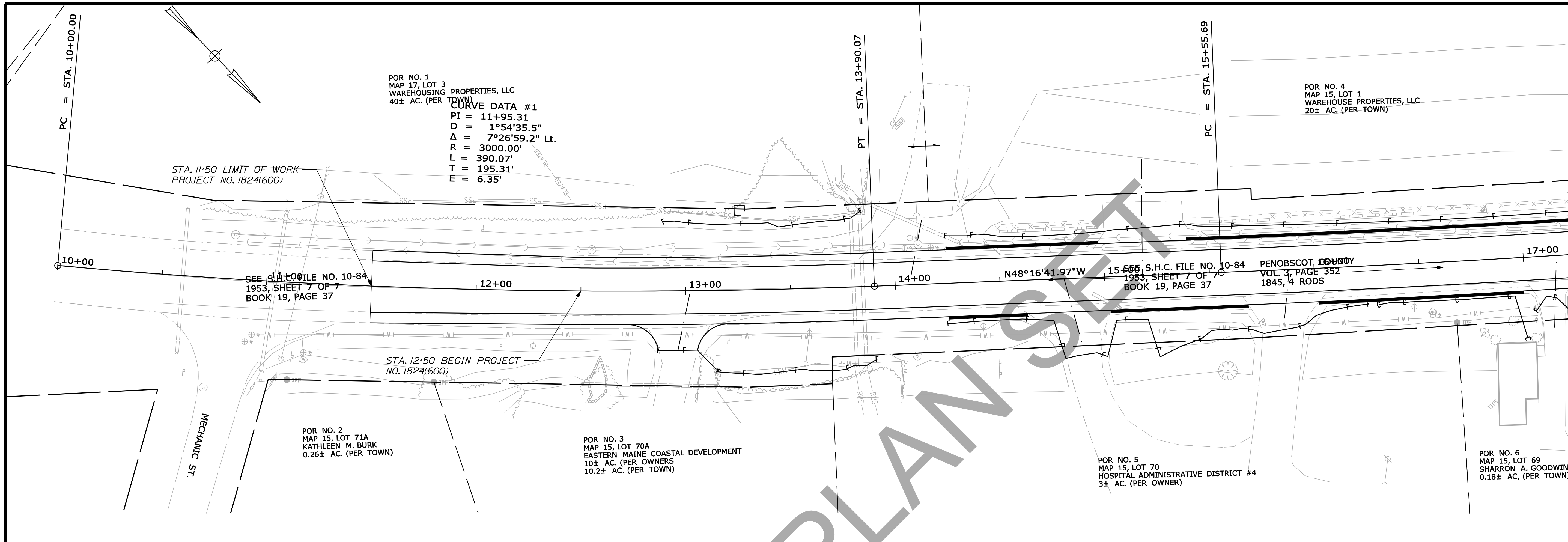

STATE OF MAINE DEPARTMENT OF TRANSPORTATION		018246.00	WIN 18246.00	HIGHWAY PLANS
	SIGNATURE	P.E. NUMBER	DATE	
PROJ. MANAGER ERNEST MARTIN	BY TRAVIS WOLFE			
DESIGN-DETAILED	CHECKED-REVIEWED	DESIGNS-DETAILED	REVISIONS 1	REVISIONS 2
DESIGNS-DETAILED	REVISIONS 3	REVISIONS 4	FIELD CHANGES	
DEXTER ROUTE 7		PLANS		
SHEET NUMBER		7		
OF 141				

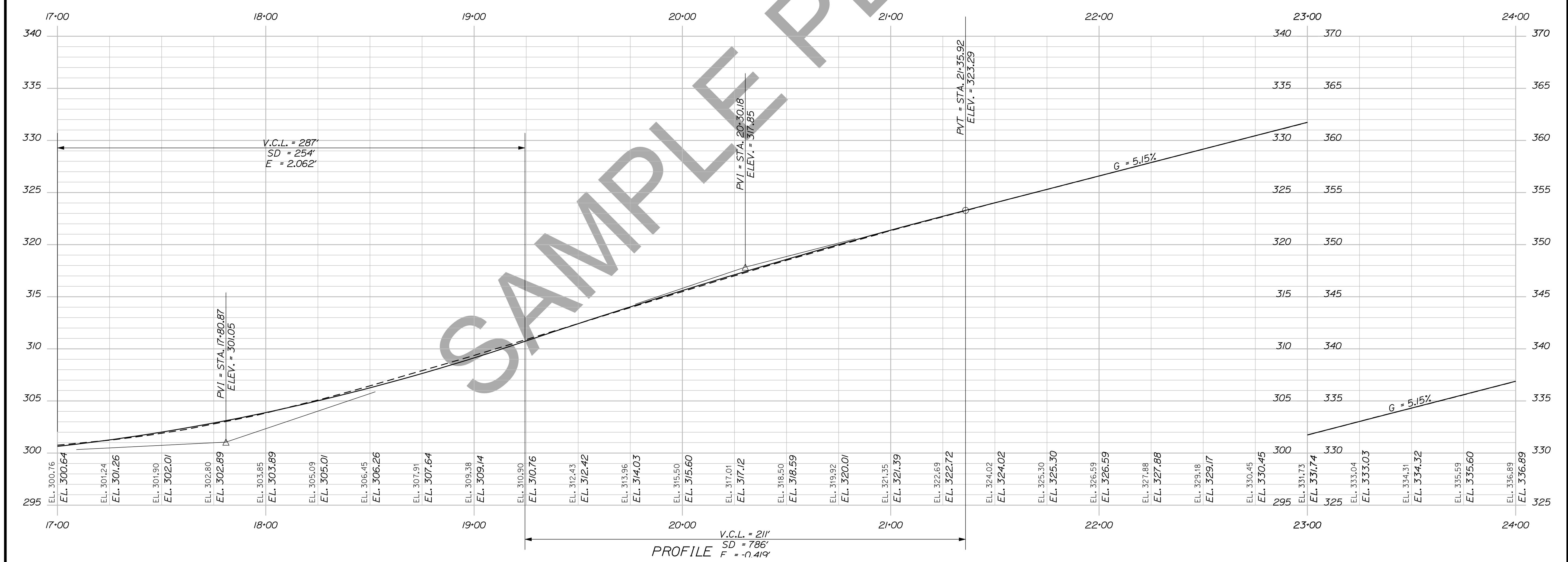
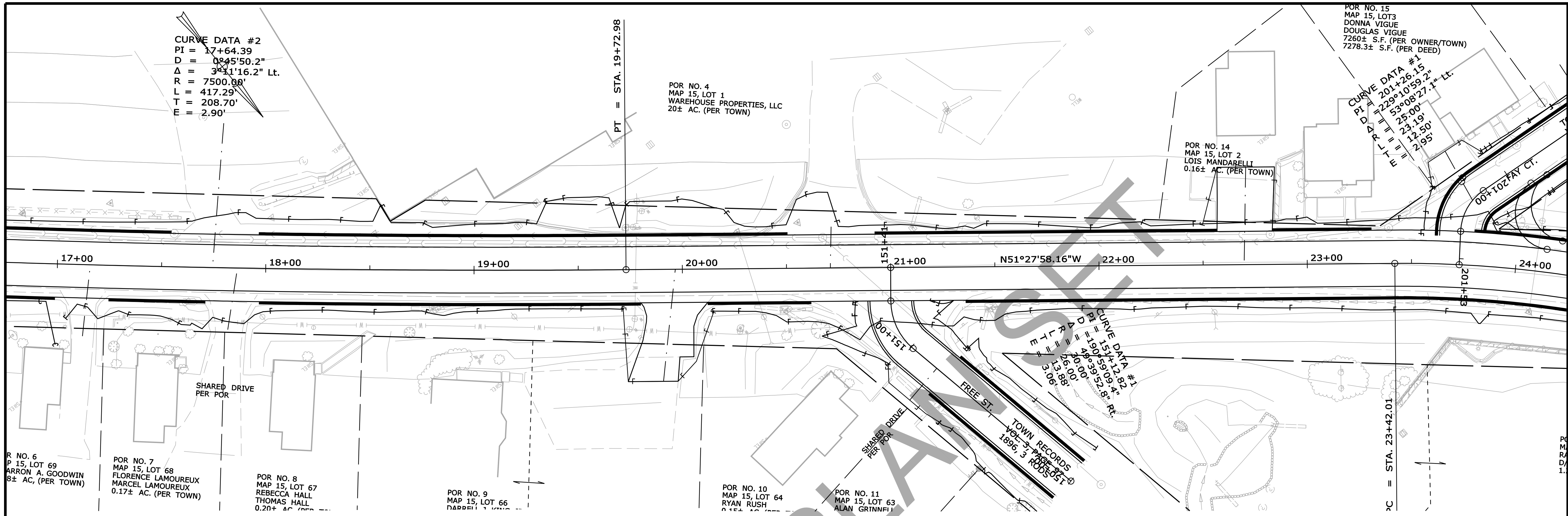

STATE OF MAINE
 DEPARTMENT OF TRANSPORTATION
 018246-00
 WIN
 18246.00
 HIGHWAY PLANS

PROJECT: DEXTER ROUTE 7 PLANS

PROJ. MGR.	BY	DATE	SIGNATURE	P.E. NUMBER	DATE
ERNEST MARTIN	TRAVIS WOLFE				
DESIGN-DETAILED					
CHECKED-REVIEWED					
DESIGN-DETAILED					
DESIGN-DETAILED					
REVISIONS 1					
REVISIONS 2					
REVISIONS 3					
REVISIONS 4					
FIELD CHANGES					

SHEET NUMBER
 8
 OF 141

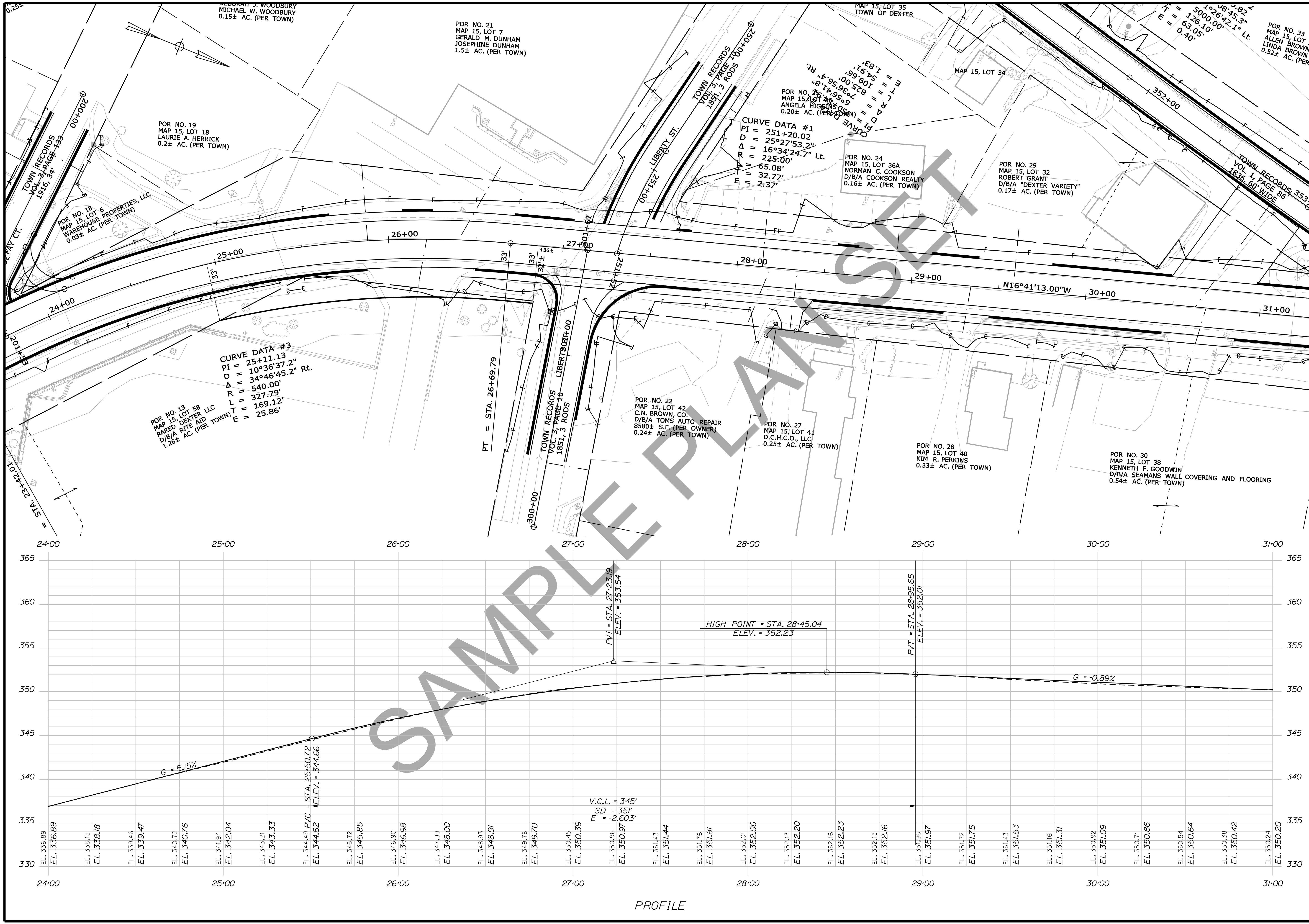

STATE OF MAINE		DEPARTMENT OF TRANSPORTATION	
018246.00		WIN	
18246.00		HIGHWAY PLANS	
PROJ. MANAGER	ERNEST MARTIN	BY	DATE
CHECKED	TRAVIS WOLFE	DESIGNED	
DESIGNED		DRAWN	
REVISIONS		DATE	
REVISIONS 1			
REVISIONS 2			
REVISIONS 3			
REVISIONS 4			
FIELD CHANGES			
DEXTER ROUTE 7		PLANS	
SHEET NUMBER		9	
OF 141			

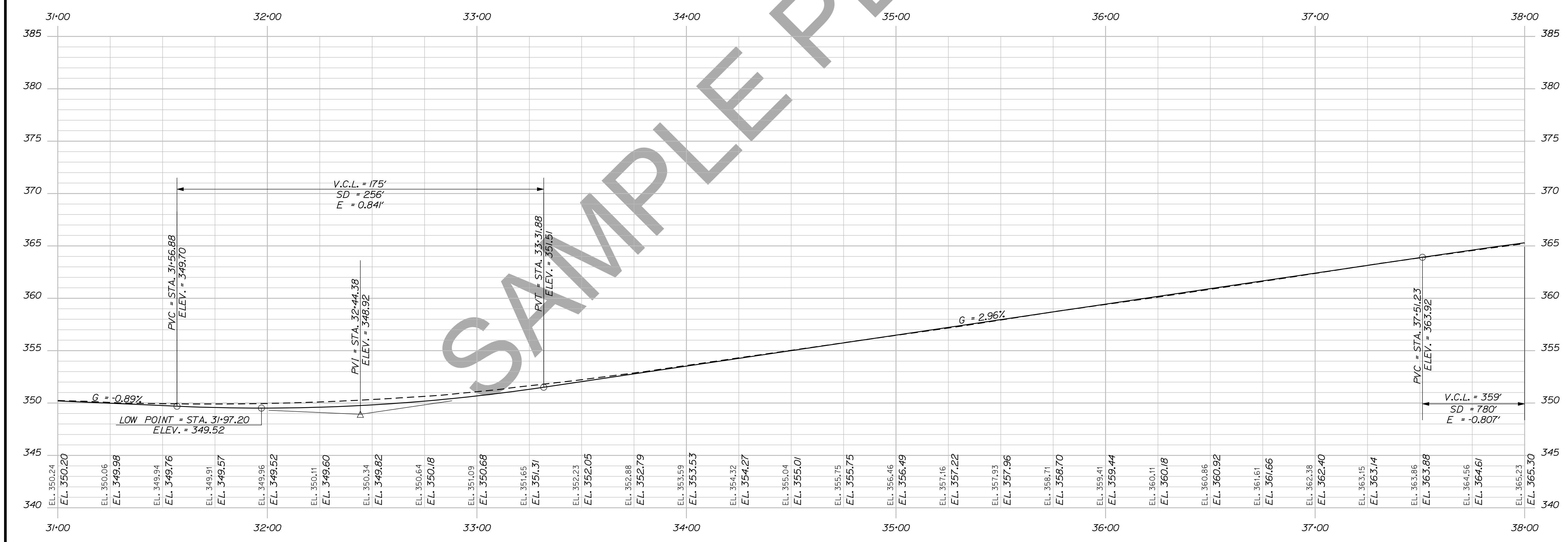
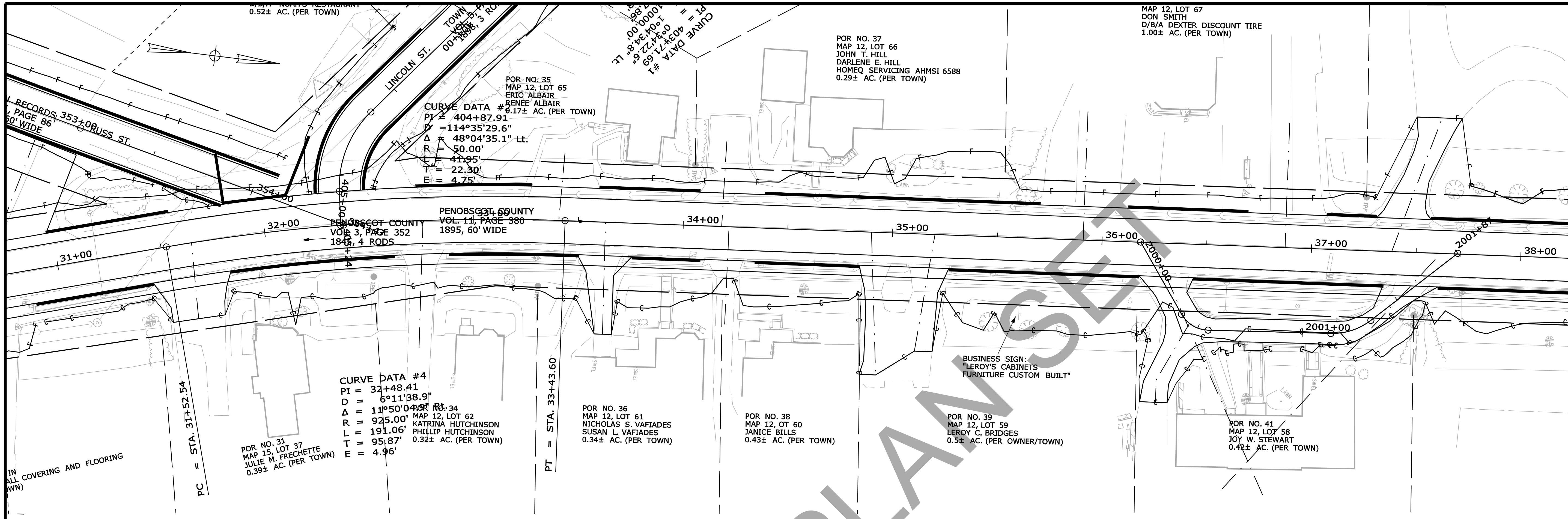

PROFILE

STATE OF MAINE		DEPARTMENT OF TRANSPORTATION	
018246.00		WIN 18246.00	
HIGHWAY PLANS		DATE	
SIGNATURE		P.E. NUMBER	
DATE		DATE	
FIELD CHANGES		FIELD CHANGES	
PROJ. MANAGER ERNEST MARTIN		BY TRAVIS WOLFE	
DESIGN-DETAILED		CHECKED-REVIEWED	
DESIGN-DETAILED		DESIGN-DETAILED	
REVISIONS 1		REVISIONS 1	
REVISIONS 2		REVISIONS 2	
REVISIONS 3		REVISIONS 3	
REVISIONS 4		REVISIONS 4	
DDEXTER ROUTE 7		PLANS	
SHEET NUMBER		10	
OF 141		OF 141	

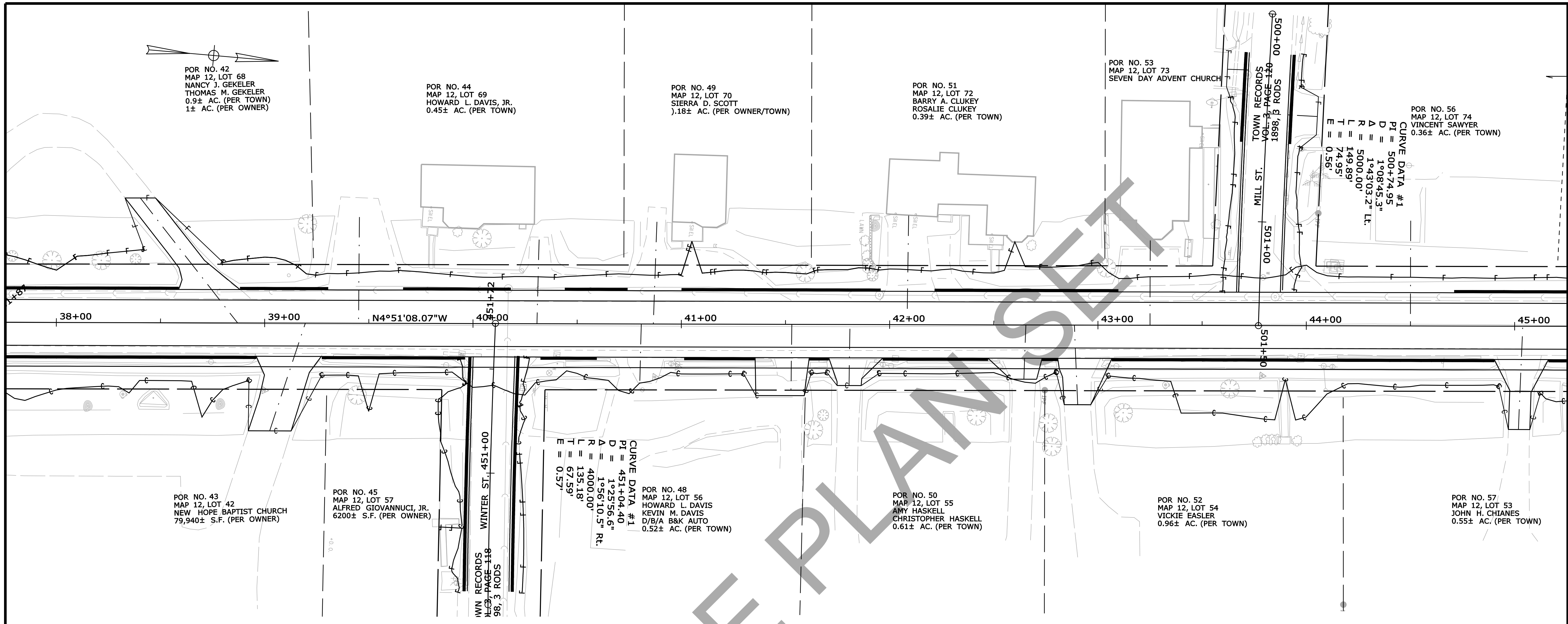

PROFILE

STATE OF MAINE
DEPARTMENT OF TRANSPORTATION
018246.00
WIN
18246.00
HIGHWAY PLANS

PROJ. MGR.	BY	DATE	SIGNATURE	P.E. NUMBER	DATE
ERNEST MARTIN	TRAVIS WOLFE				
DESIGN-DETAILED					
CHECKED-REVIEWED					
DESIGN-DETAILED					
DESIGN-DETAILED					
REVISIONS 1					
REVISIONS 2					
REVISIONS 3					
REVISIONS 4					
FIELD CHANGES					

DEXTER
ROUTE 7
PLANS

SHEET NUMBER
11
OF 141

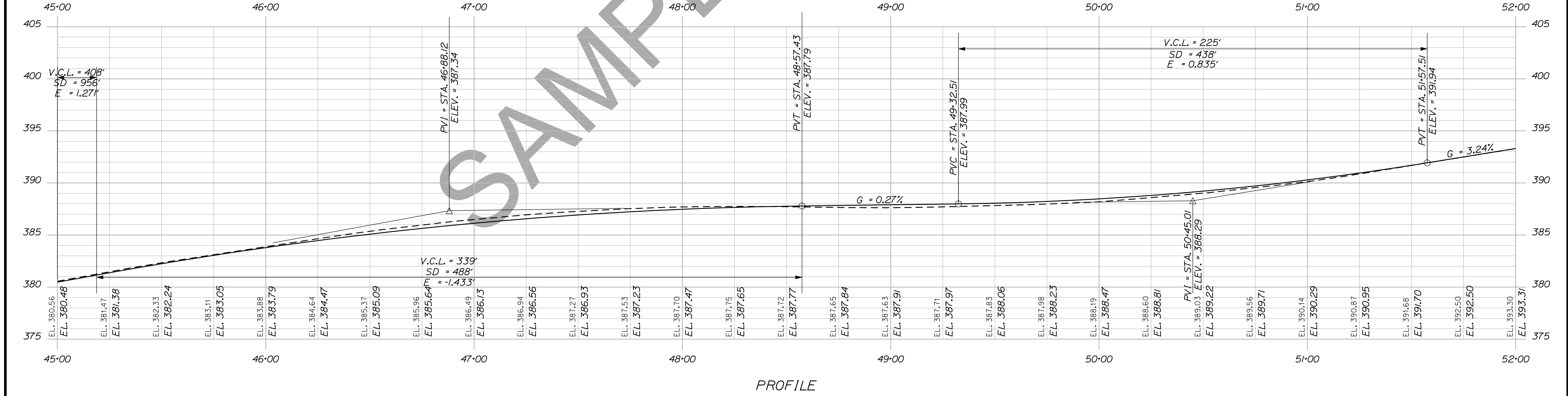
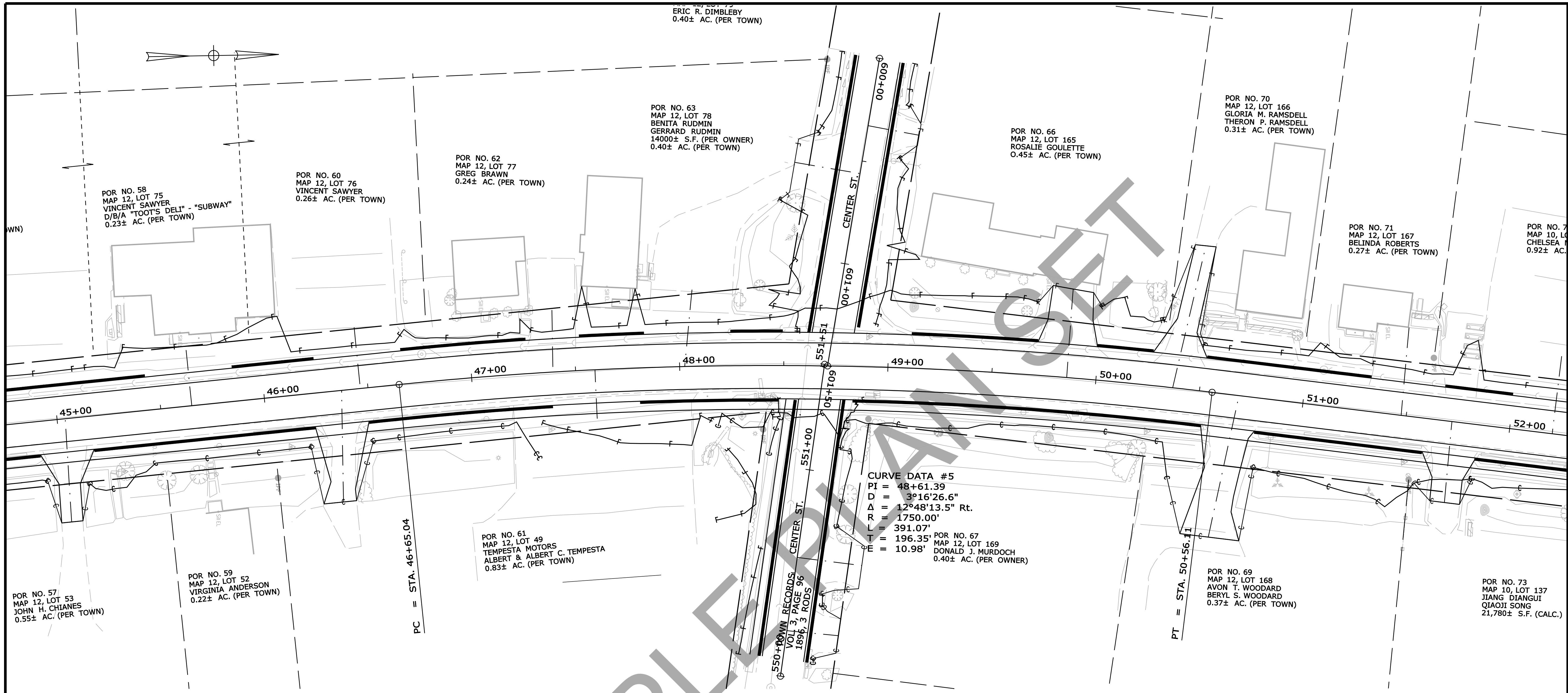

STATE OF MAINE
DEPARTMENT OF TRANSPORTATION

018246.00
WIN
18246.00
HIGHWAY PLANS

DEXTER
ROUTE 7
PLANS

SHEET NUMBER
12
OF 141

PROJ. MGR.	BY	DATE
ERNEST MARTIN	TRAVIS WOLFE	

DESIGN	REVIEWED	DATE
DESIGN-DETAILED		
CHECKED-REVIEWED		
DESIGN-DETAILED		
DESIGN-DETAILED		
REVISIONS 1		
REVISIONS 2		
REVISIONS 3		
REVISIONS 4		
FIELD CHANGES		

SIGNATURE	P.E. NUMBER	DATE

Date: 12/10/2013

Username: otlee.mousseau

Division: HIGHWAY

Filename: ... \013_HDPLAN.DGN

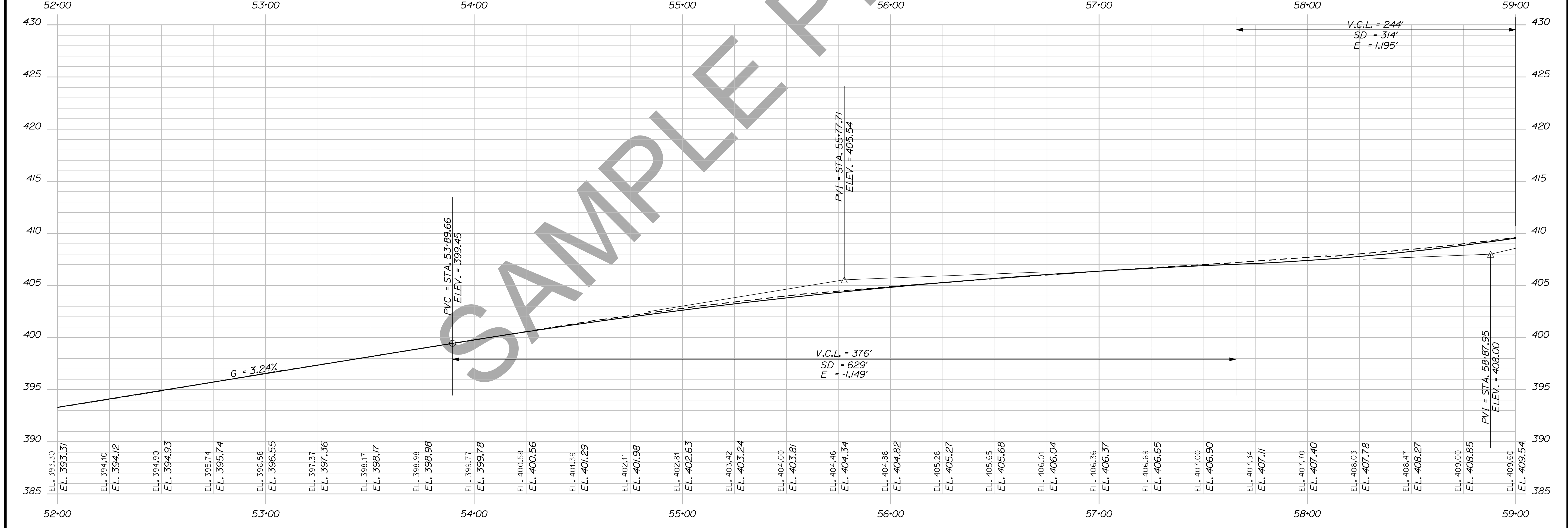
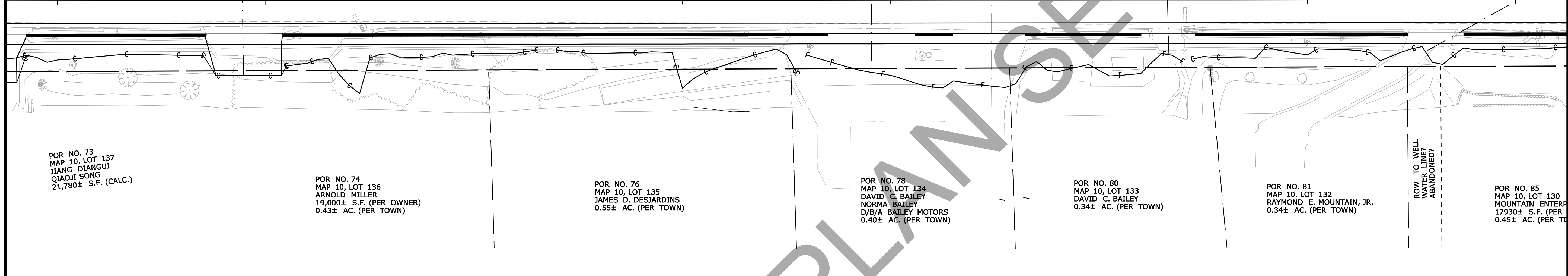
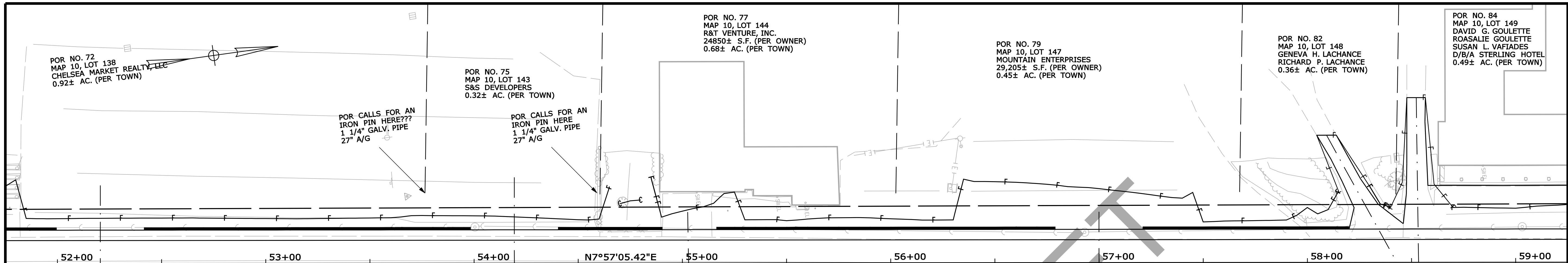

PROFILE

STATE OF MAINE
DEPARTMENT OF TRANSPORTATION
018246-00
WIN
18246.00
HIGHWAY PLANS

PROJ. MANAGER	ERNEST MARTIN	DATE
DESIGN-DETAILED	TRAVIS WOLFE	
CHECKED-REVIEWED		
DESIGN-DETAILED		
DESIGN-DETAILED		
REVISIONS 1		
REVISIONS 2		
REVISIONS 3		
REVISIONS 4		
FIELD CHANGES		

DEXTER
ROUTE 7
PLANS

SHEET NUMBER
13
OF 141

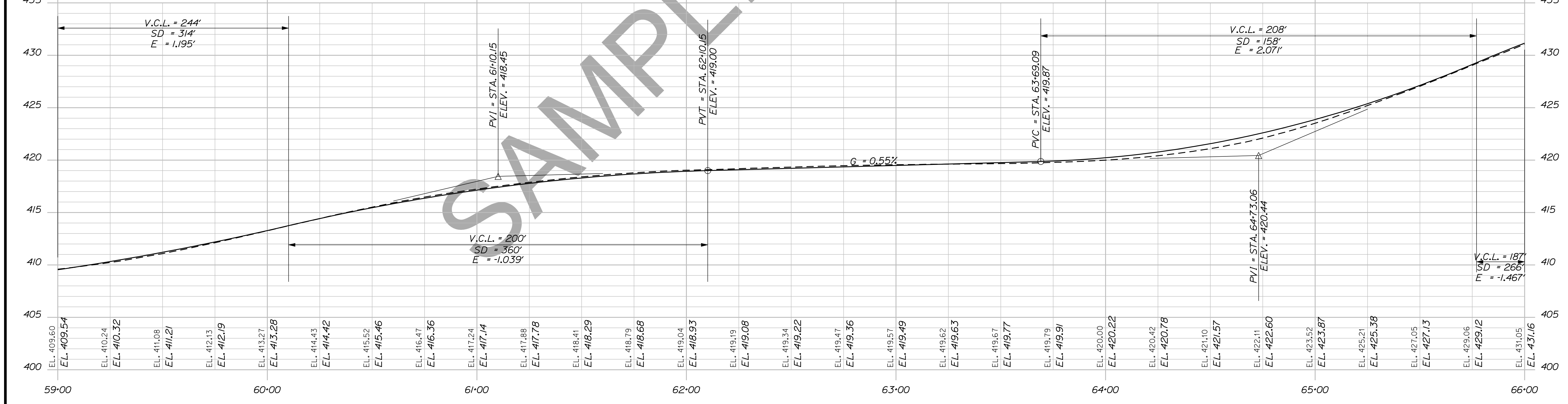
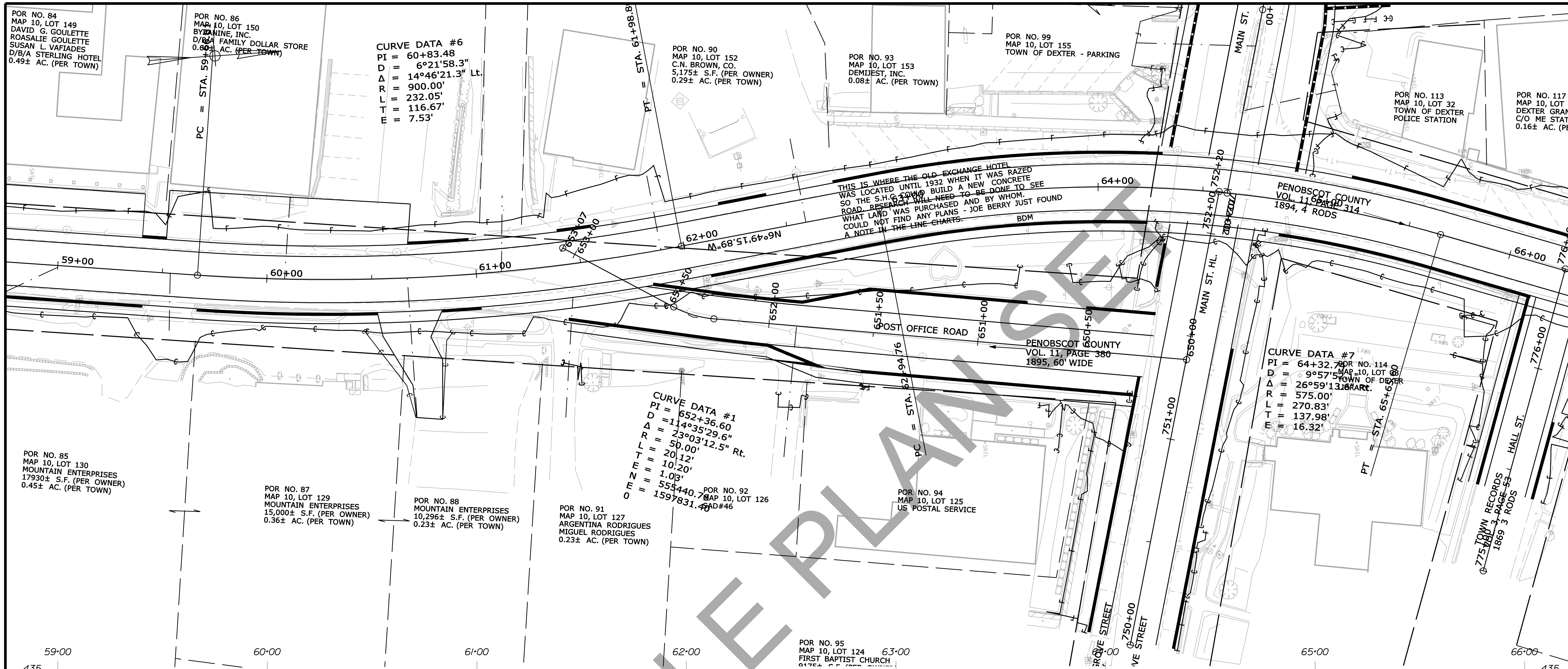

PROFILE

STA. 59+00.00 TO STA. 66+00.00

STATE OF MAINE DEPARTMENT OF TRANSPORTATION		018246-00	WIN 18246.00	HIGHWAY PLANS
DEXTER ROUTE 7 PLANS				
SHEET NUMBER		14		
OF 141				

PROJ. MANAGER	ERNEST MARTIN	BY	DATE
DESIGN-DETAILED	TRAVIS WOLFE		
CHECKED-REVIEWED			
DESIGN-DETAILED			
DESIGN-DETAILED			
REVISIONS 1			
REVISIONS 2			
REVISIONS 3			
REVISIONS 4			
FIELD CHANGES			

SIGNATURE	P.E. NUMBER	DATE

Date: 12/10/2013

Username: atlee.mousseau

Division: HIGHWAY

Filename: ... \015_HDPLAN.DGN

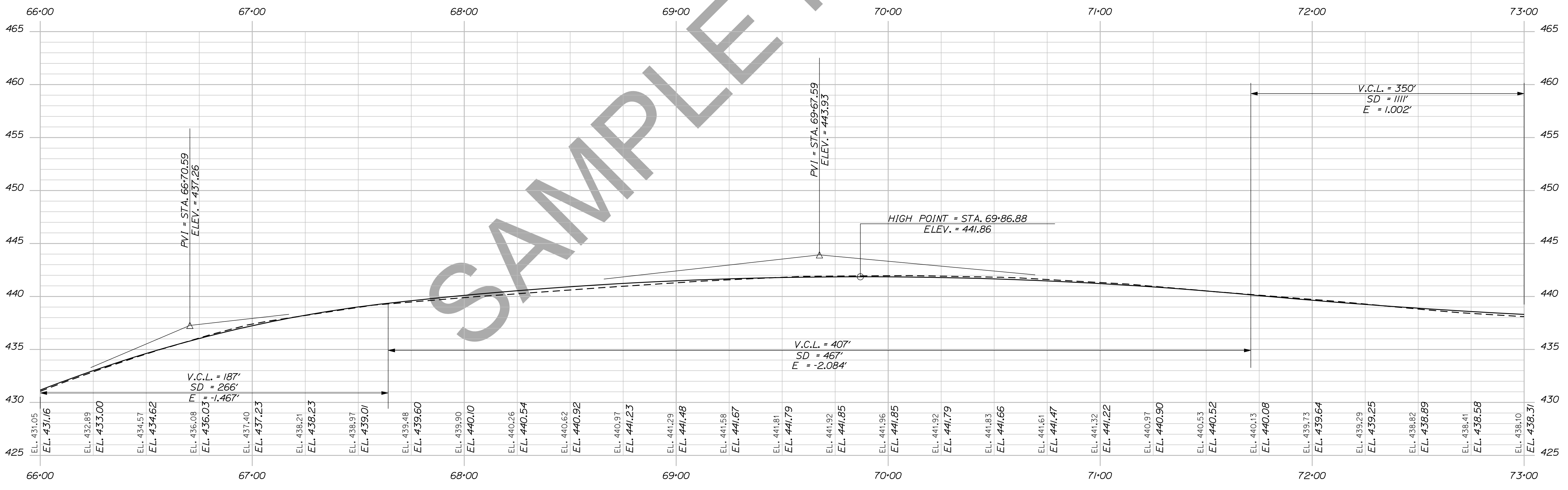
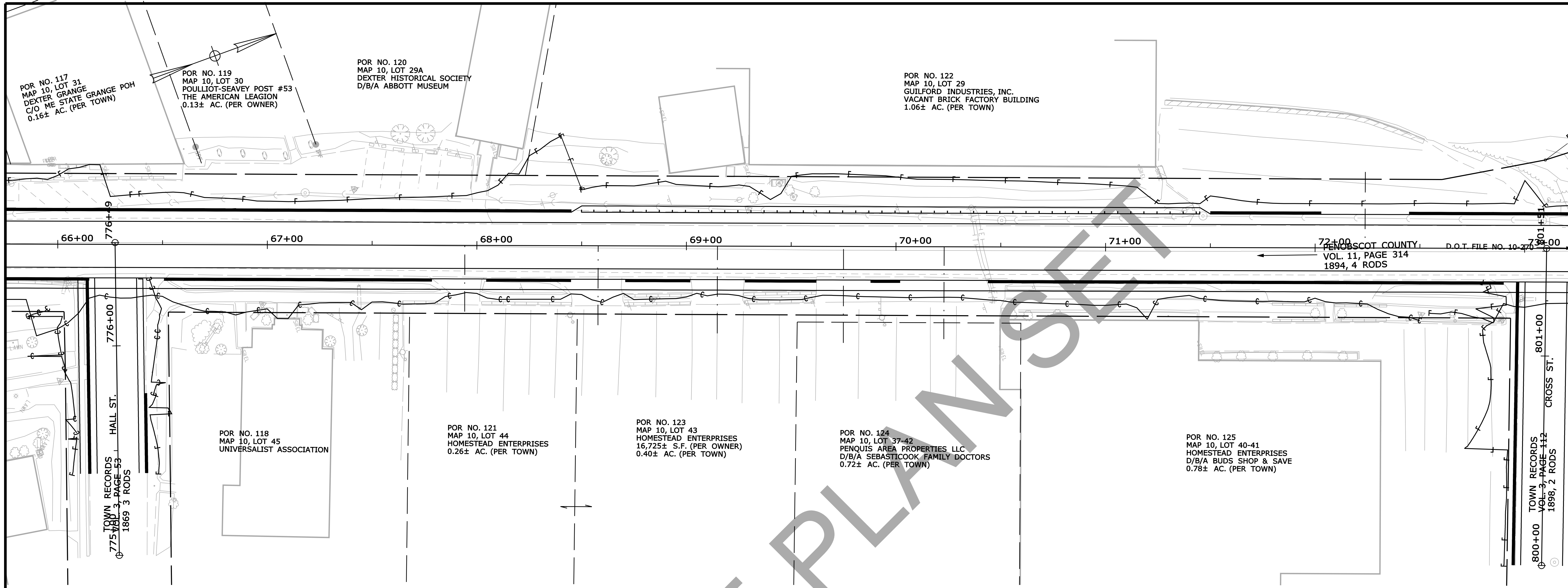

PROFILE

STA. 66+00.00 TO STA. 73+00.00

STATE OF MAINE
DEPARTMENT OF TRANSPORTATION

018246-00
WIN
18246.00
HIGHWAY PLANS

PROJ. MGR.	BY	DATE
ERNEST MARTIN	TRAVIS WOLFE	
DESIGN-DETAILED		SIGNATURE
CHECKED-REVIEWED		P.E. NUMBER
DESIGNS-DETAILED		DATE
DESIGNS-DETAILED		
REVISIONS 1		
REVISIONS 2		
REVISIONS 3		
REVISIONS 4		
FIELD CHANGES		

DEXTER
ROUTE 7
PLANS

SHEET NUMBER
15
OF 141

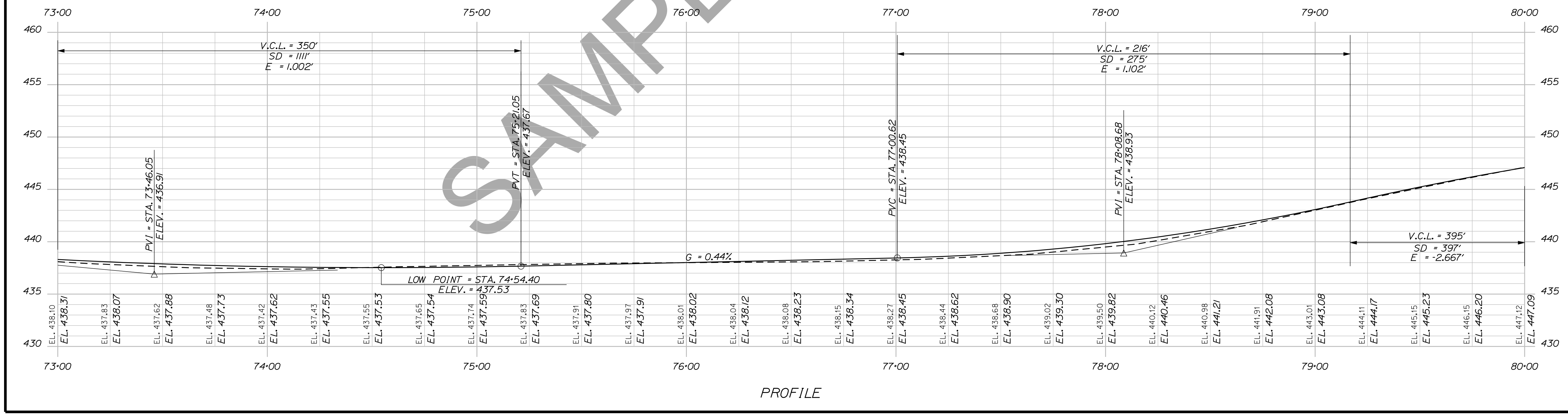
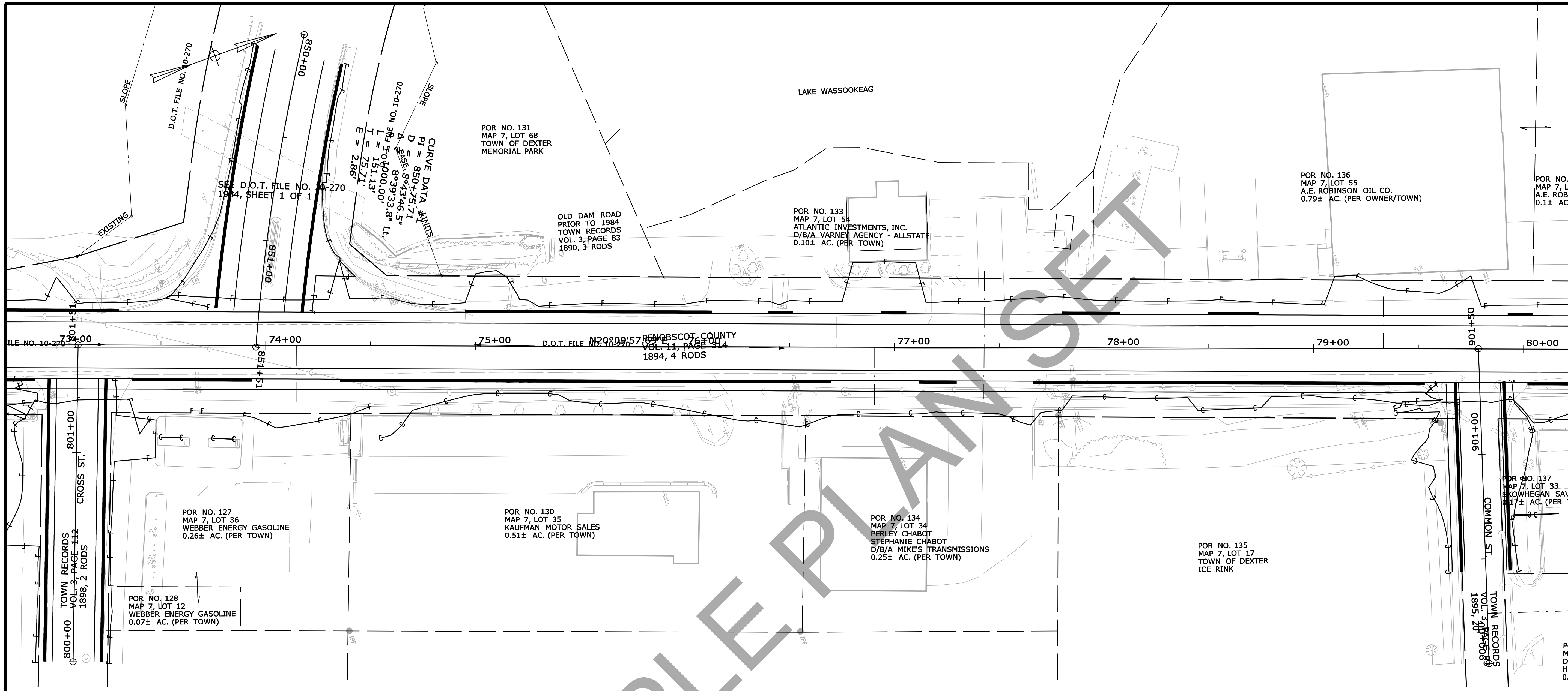

DEXTER ROUTE 7 PLANS

SHEET NUMBER **16** OF 141

STA. 73+00.00 TO STA. 80+00.00

STATE OF MAINE		DEPARTMENT OF TRANSPORTATION
WIN		018246.00
HIGHWAY PLANS		18246.00
PROJ. MGR.	ERNEST MARTIN	DATE
DESIGN	TRAVIS WOLFE	SIGNATURE
CHECKED	TRAVIS WOLFE	P.E. NUMBER
DESIGNED	TRAVIS WOLFE	DATE
REVISIONS	1	
REVISIONS	2	
REVISIONS	3	
REVISIONS	4	
FIELD CHANGES		

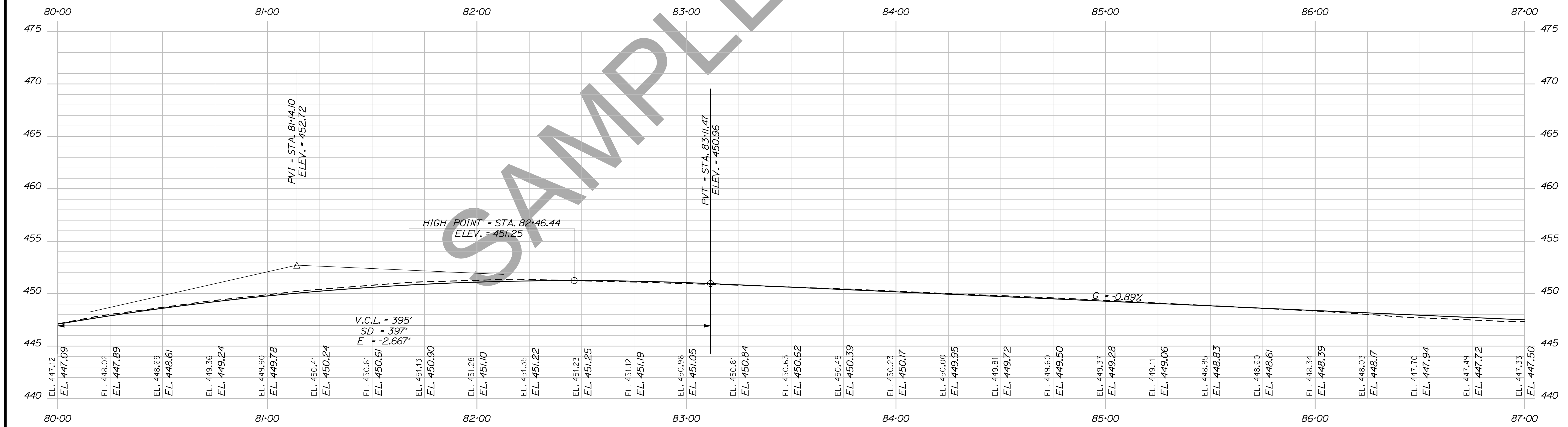
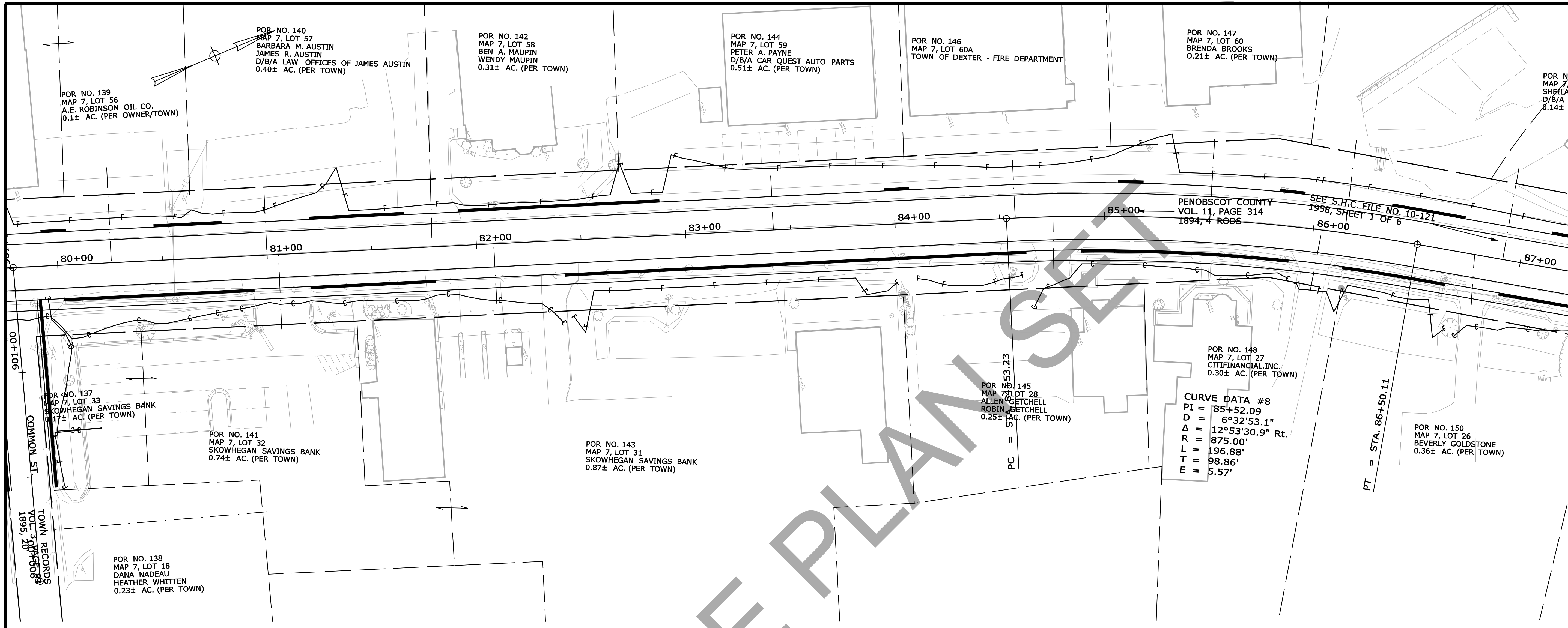

PROFILE

STA. 80+00.00 TO STA. 87+00.00

STATE OF MAINE		DEPARTMENT OF TRANSPORTATION		018246-00	
PROJECT NUMBER		SIGNATURE		WIN	
SHEET NUMBER		P.E. NUMBER		18246.00	
17		DATE		HIGHWAY PLANS	
OF 141		FIELD CHANGES			
PROJ. MANAGER	ERNEST MARTIN	BY	DATE		
CHECKED-REVIEWED	TRAVIS WOLFE				
DESIGN-DETAILED					
DESIGNS DETAILED					
REVISIONS 1					
REVISIONS 2					
REVISIONS 3					
REVISIONS 4					
DEXTER ROUTE 7 PLANS					

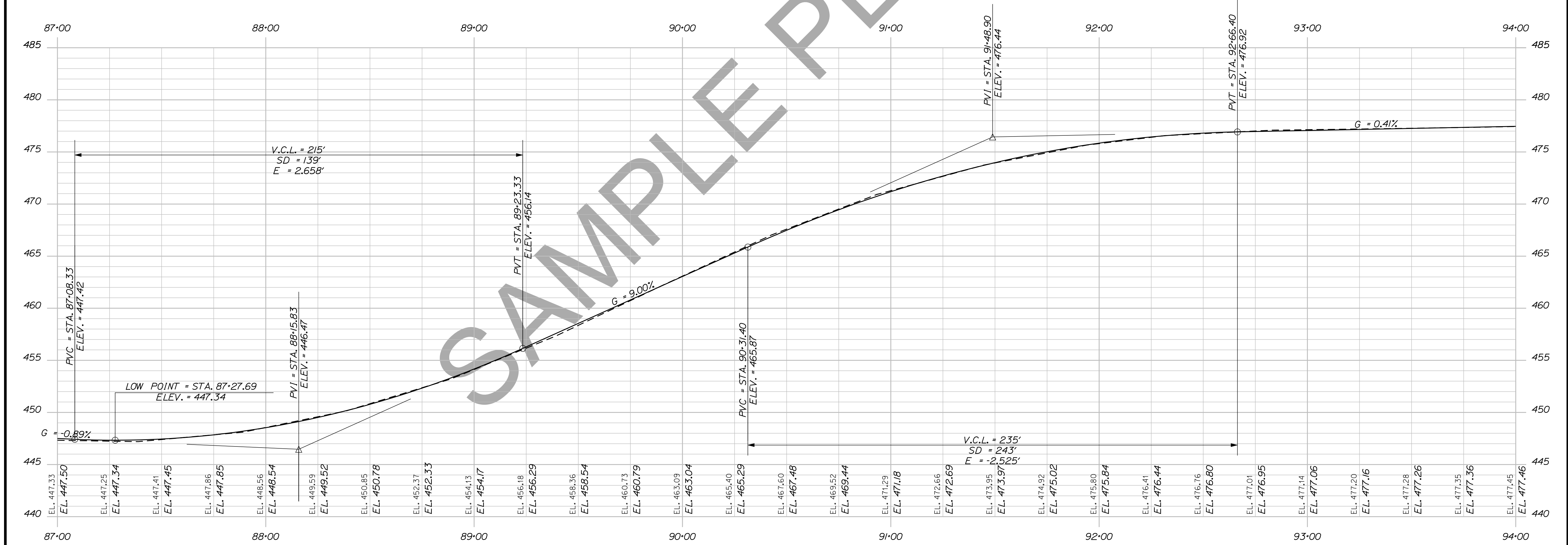
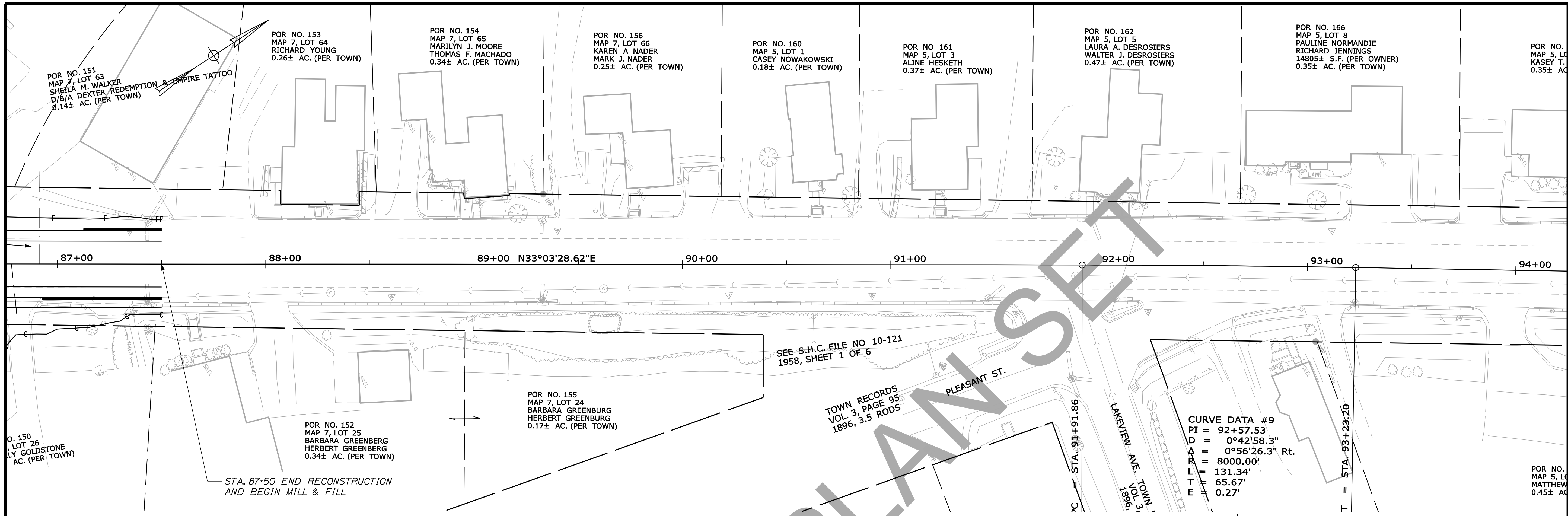

STATE OF MAINE
DEPARTMENT OF TRANSPORTATION

018246.00
WIN
18246.00
HIGHWAY PLANS

PROJ. MANAGER	BY	DATE
ERNEST MARTIN	TRAVIS WHEELER	
DESIGN-DETAILED		
CHECKED-REVIEWED		
DESIGN-DETAILED		
DESIGN-DETAILED		
REVISIONS 1		
REVISIONS 2		
REVISIONS 3		
REVISIONS 4		
FIELD CHANGES		

DEXTER
ROUTE 7
PLANS

SHEET NUMBER
18
OF 141

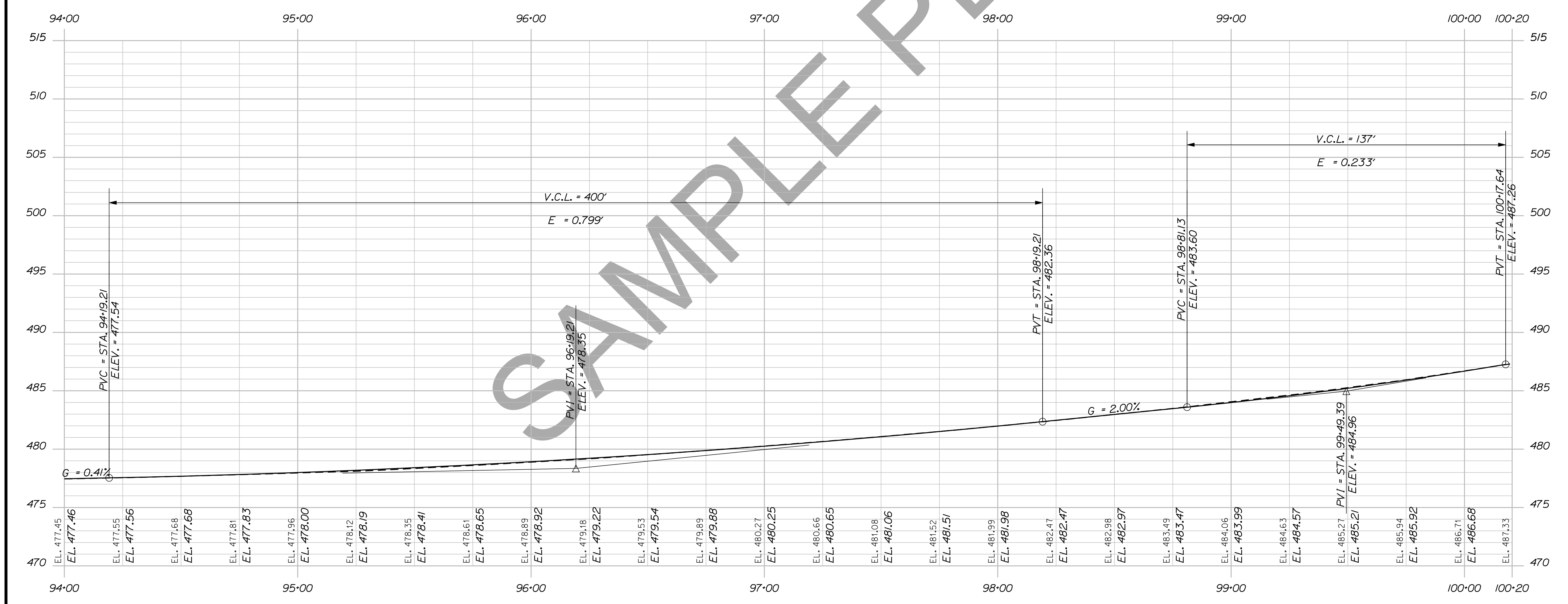
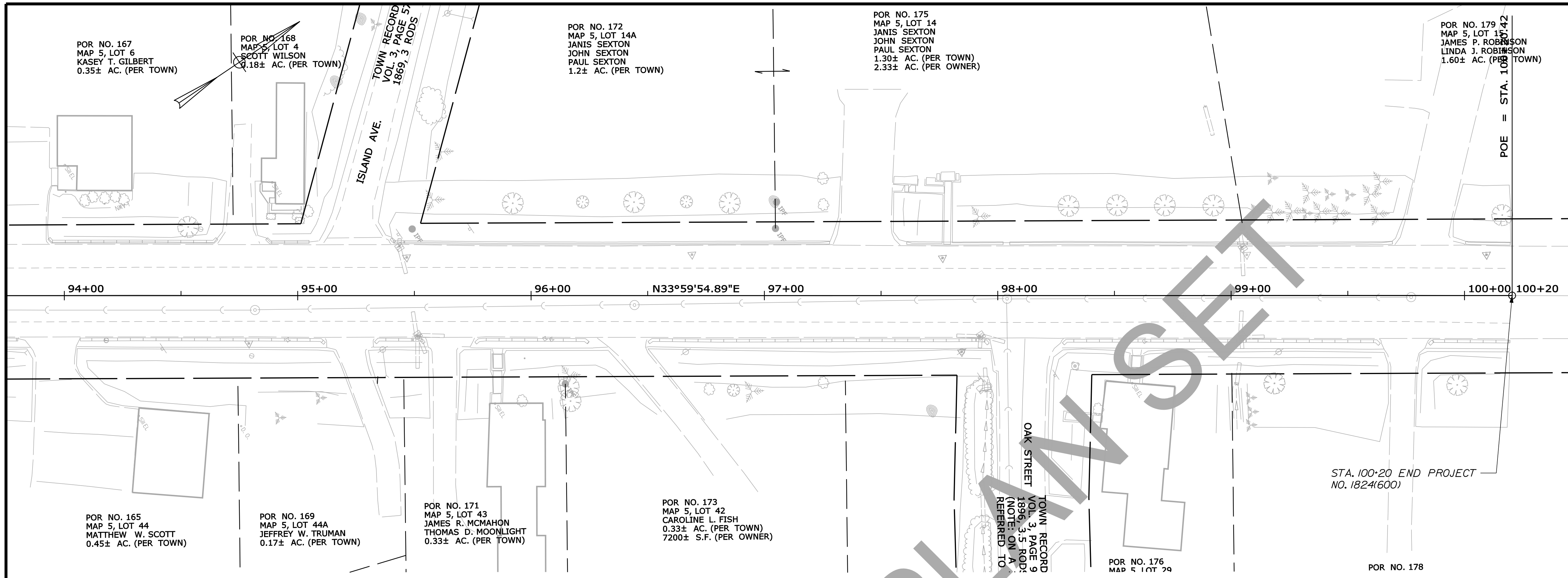

PROFILE

STATE OF MAINE DEPARTMENT OF TRANSPORTATION		SIGNATURE
018246-00		P.E. NUMBER
WIN 18246.00		DATE
HIGHWAY PLANS		
DEXTER ROUTE 7 PLANS		
SHEET NUMBER 19 OF 141		

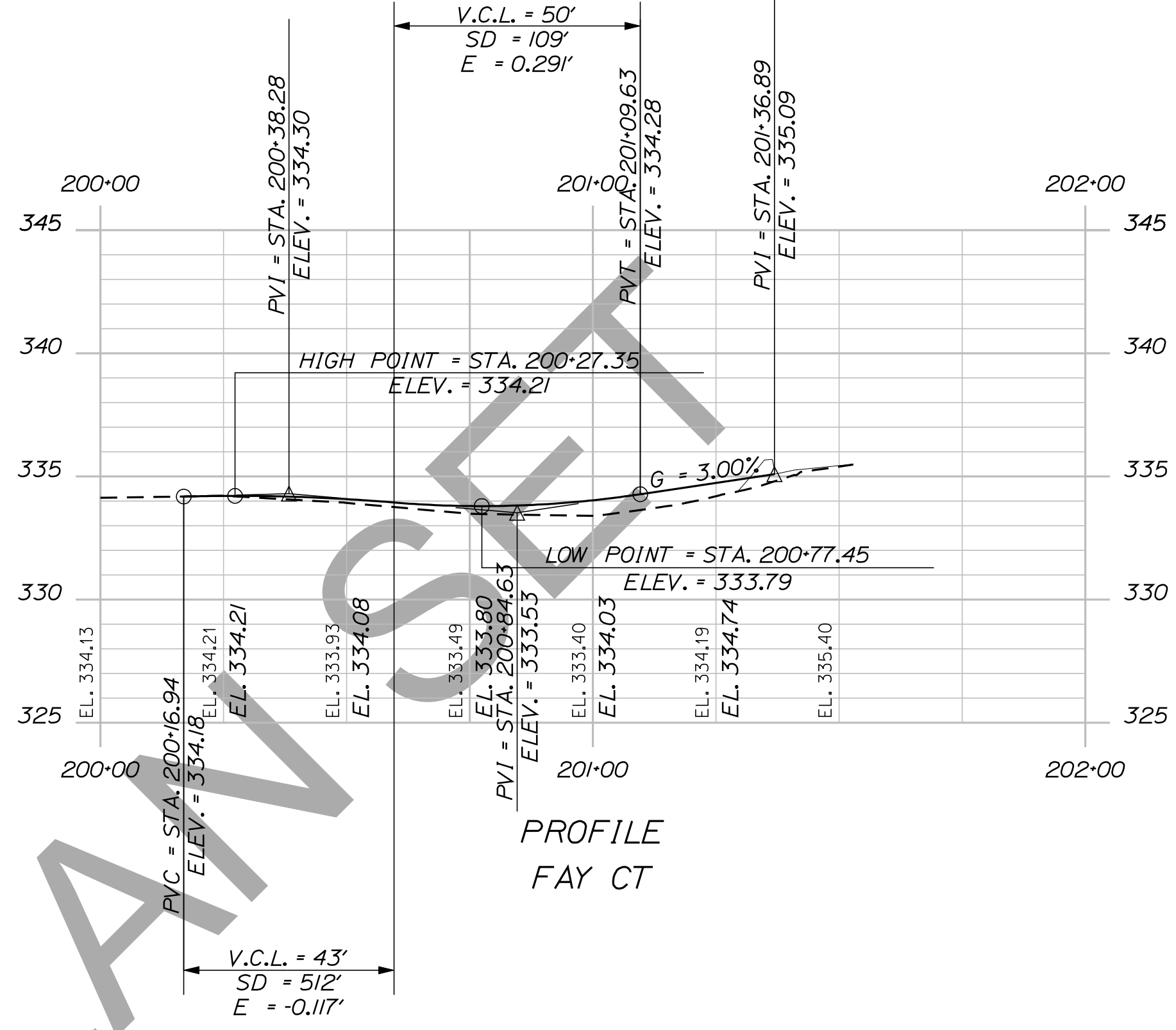
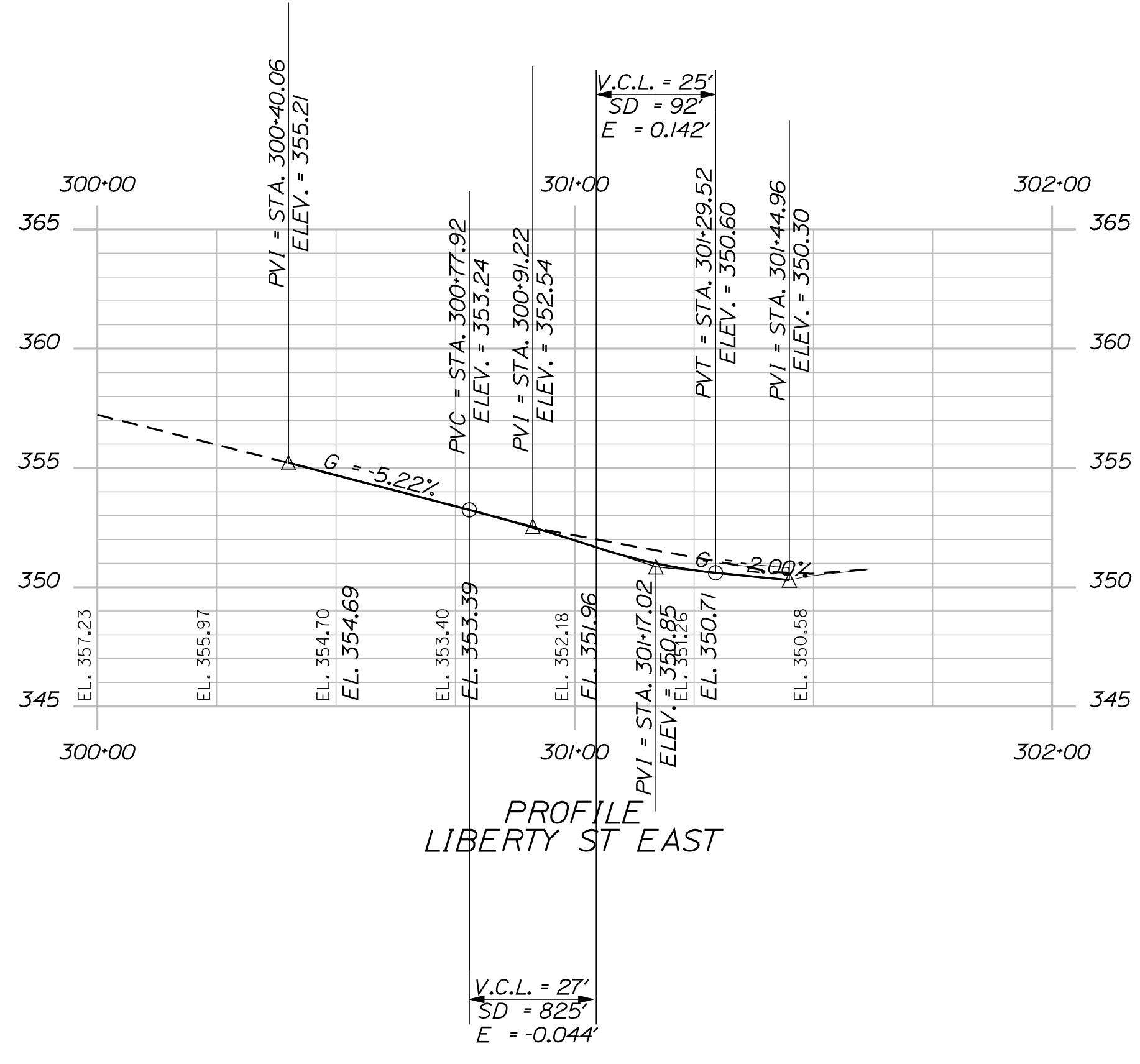
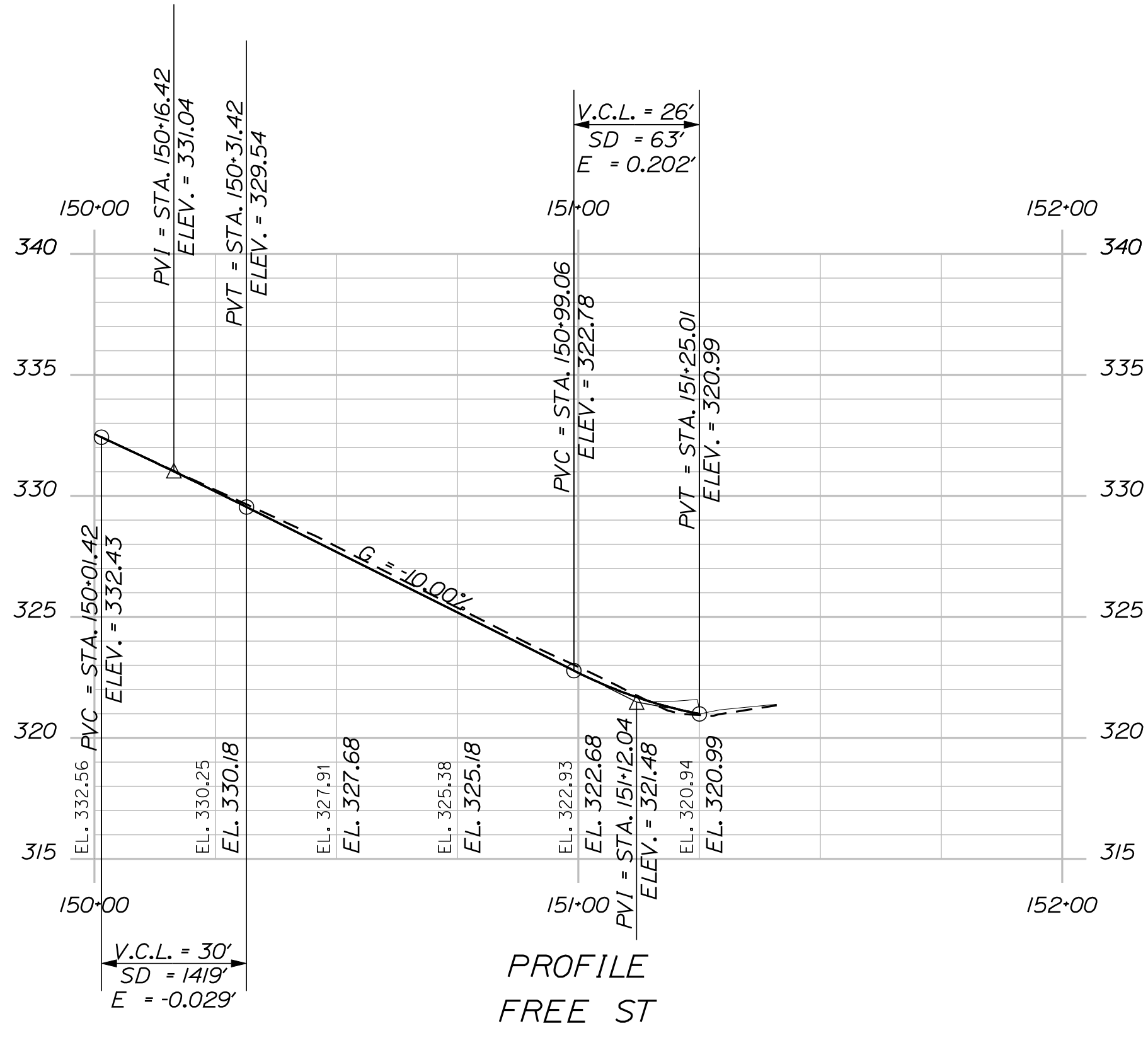
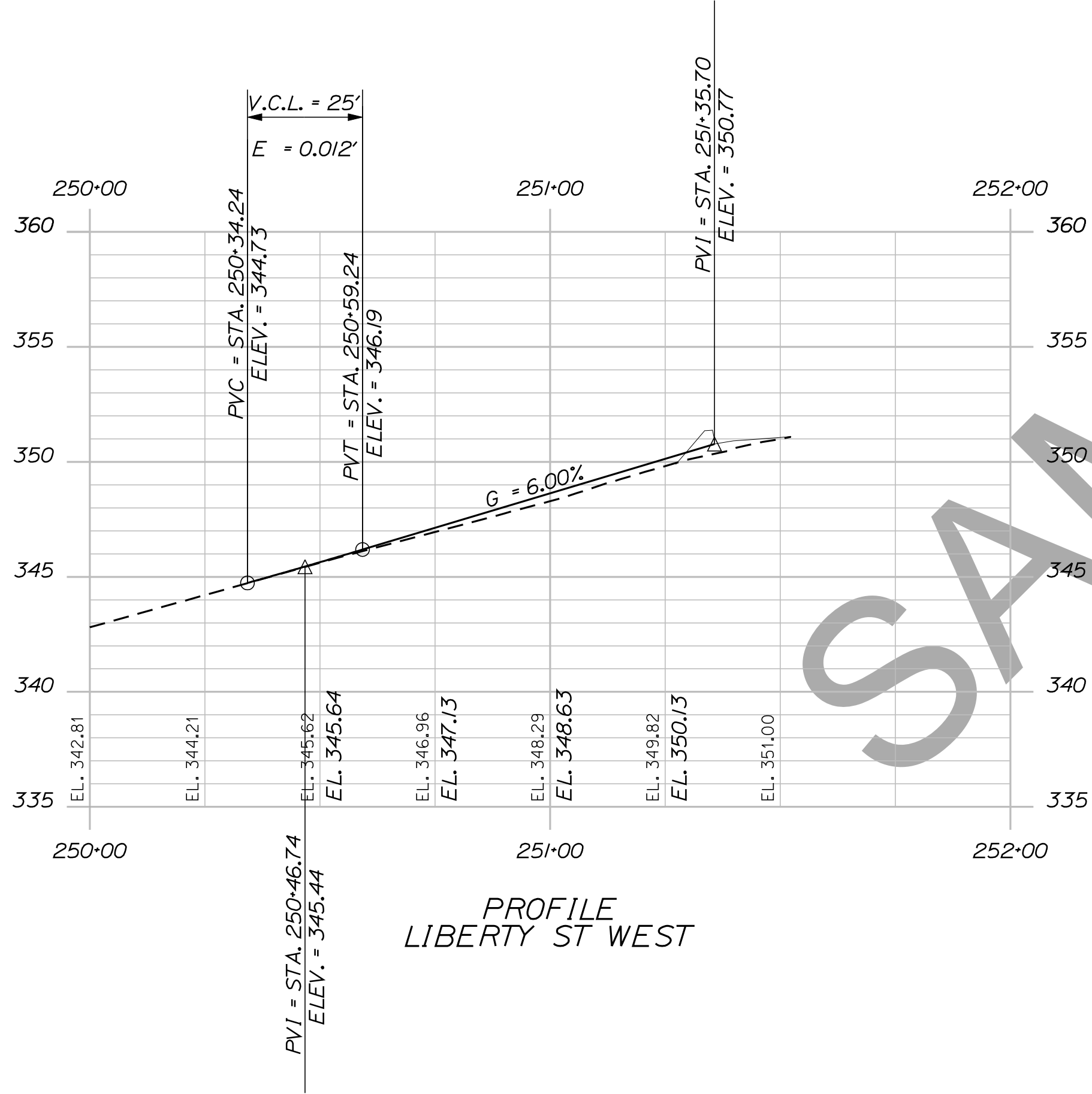

SHEET NUMBER

29

OF 141

DEXTER
ROUTE 7
PROFILE

PROJ. MANAGER	BY	DATE
ERNEST MARTIN	TRAVIS WOIWEL	
CHECKED-REVIEWED		
DESIGNED-REVIEWED		
DESIGNED-DATE		
REVISIONS 1		
REVISIONS 2		
REVISIONS 3		
REVISIONS 4		
FIELD CHANGES		

STATE OF MAINE
DEPARTMENT OF TRANSPORTATION
018246.00
WIN
18246.00
HIGHWAY PLANS

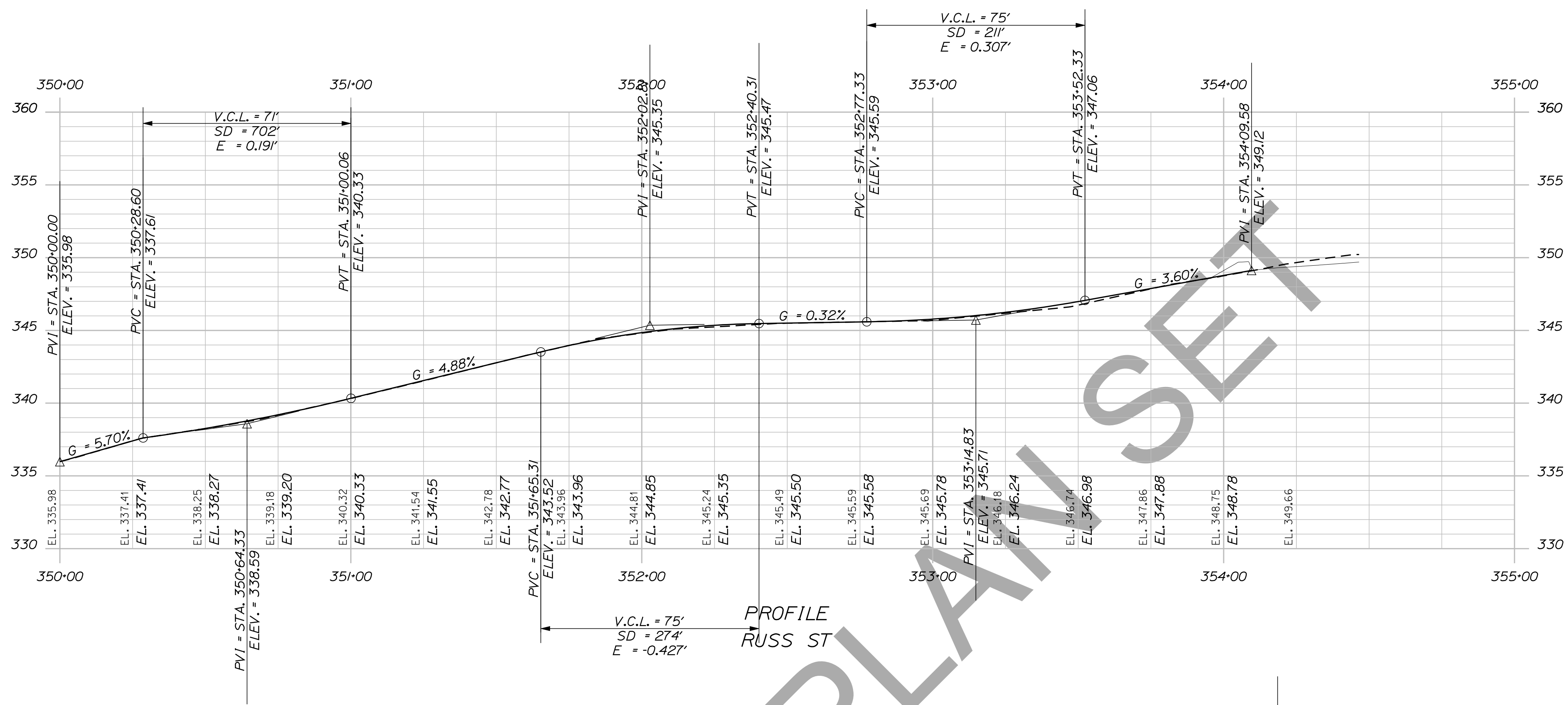
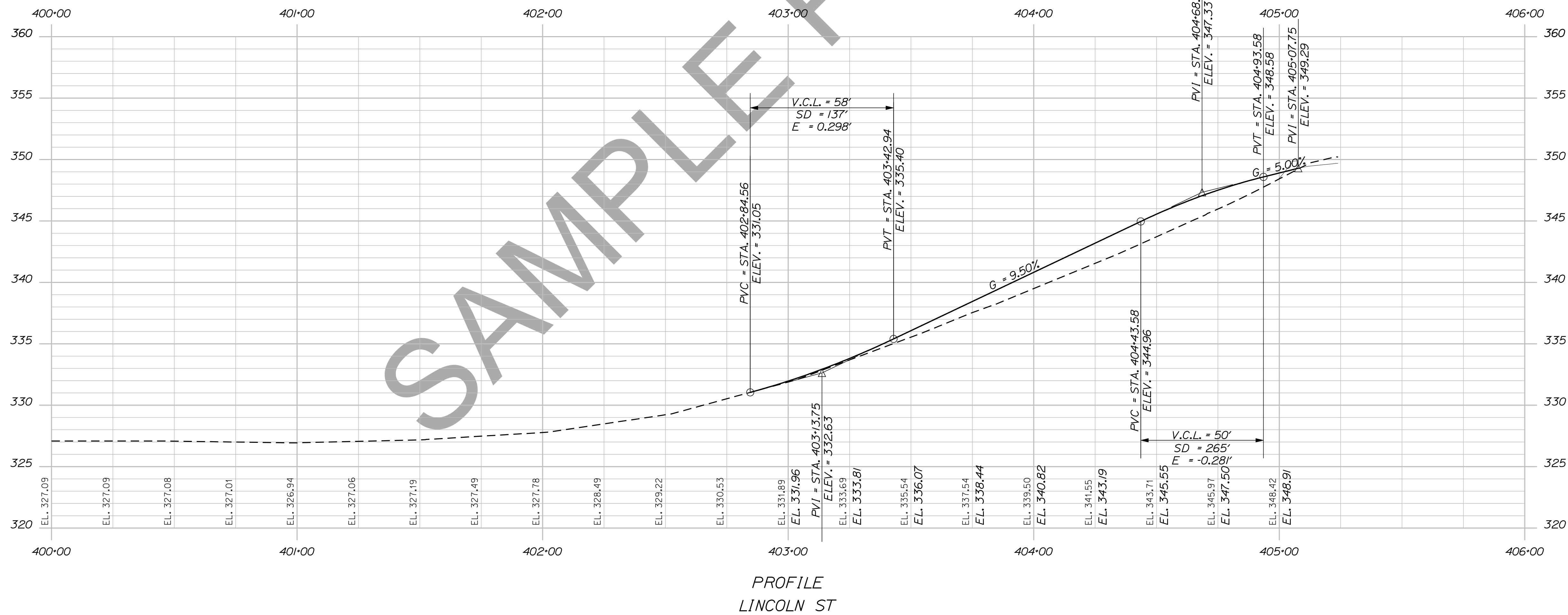

SHEET NUMBER

30

OF 141

DEXTER ROUTE 7 PROFILE

DESIGN-DETAILED	CHECKED-REVIEWED	DESIGNS-DETAILED	REVISIONS 1	REVISIONS 2	REVISIONS 3	REVISIONS 4	FIELD CHANGES
TRAVIS WOLFE							

PROJ. MANAGER	BY	DATE
ERNEST MARTIN	TRAVIS WOLFE	

STATE OF MAINE	DEPARTMENT OF TRANSPORTATION
018246-00	WIN
18246.00	HIGHWAY PLANS

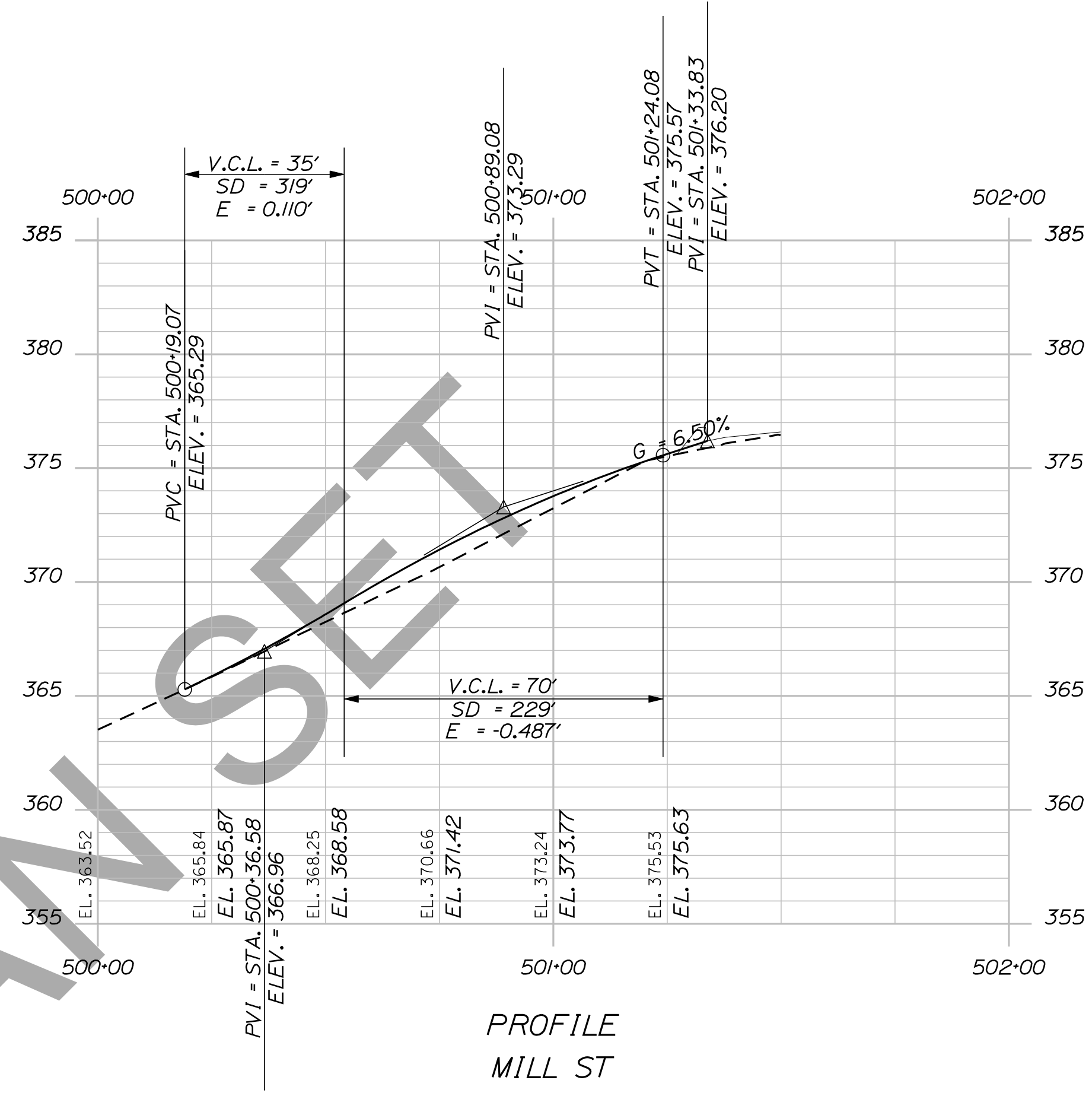
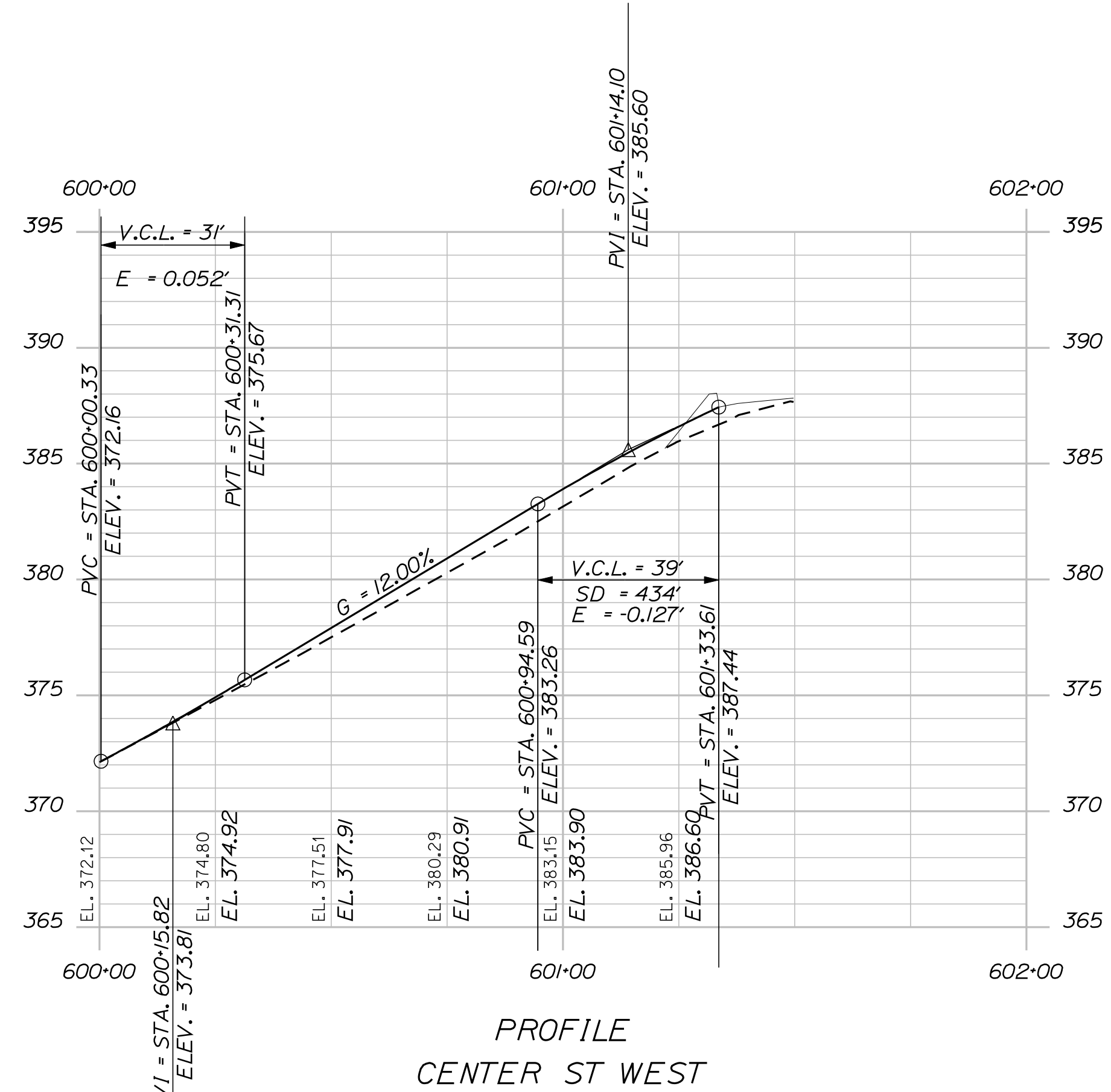
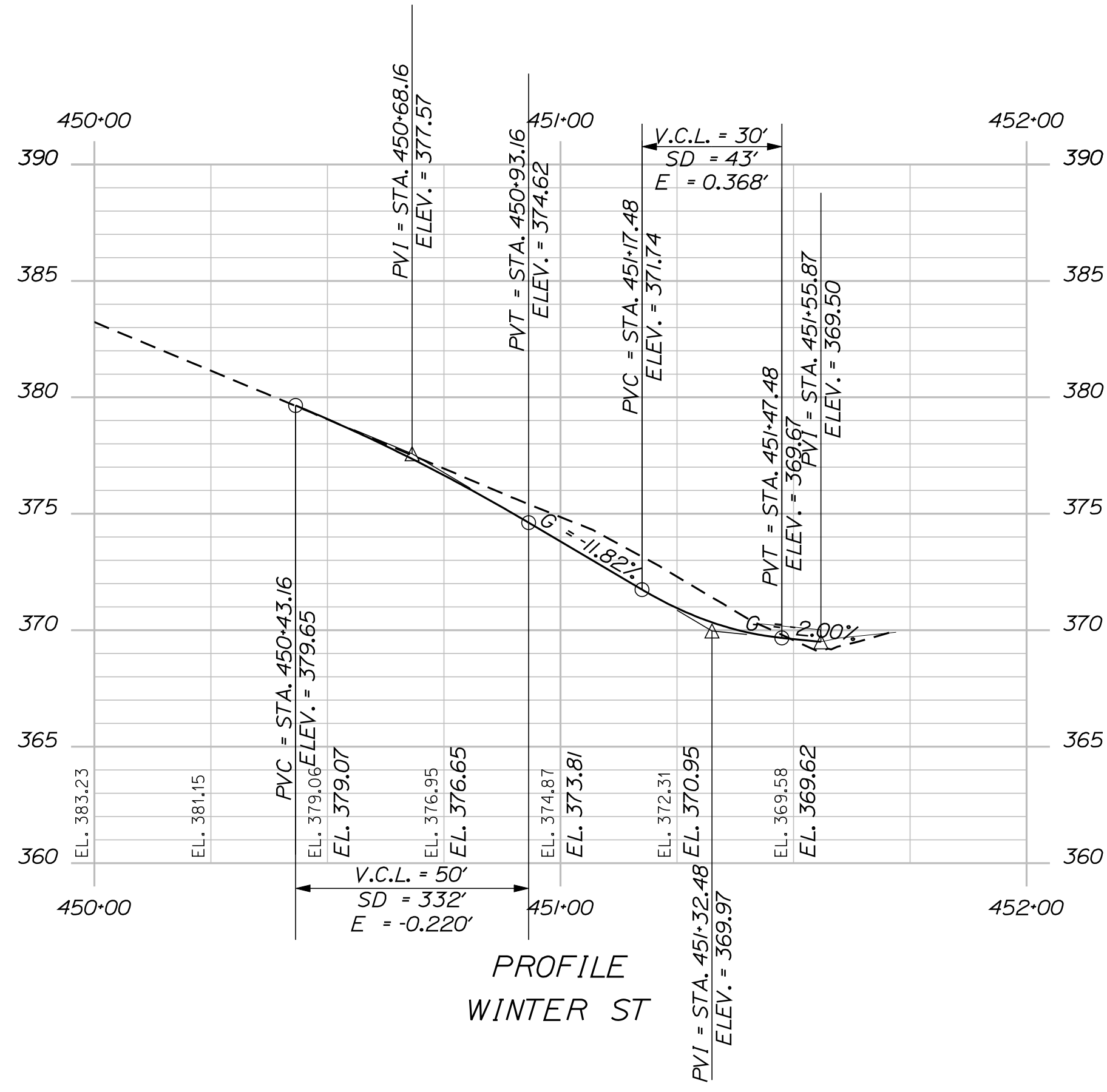
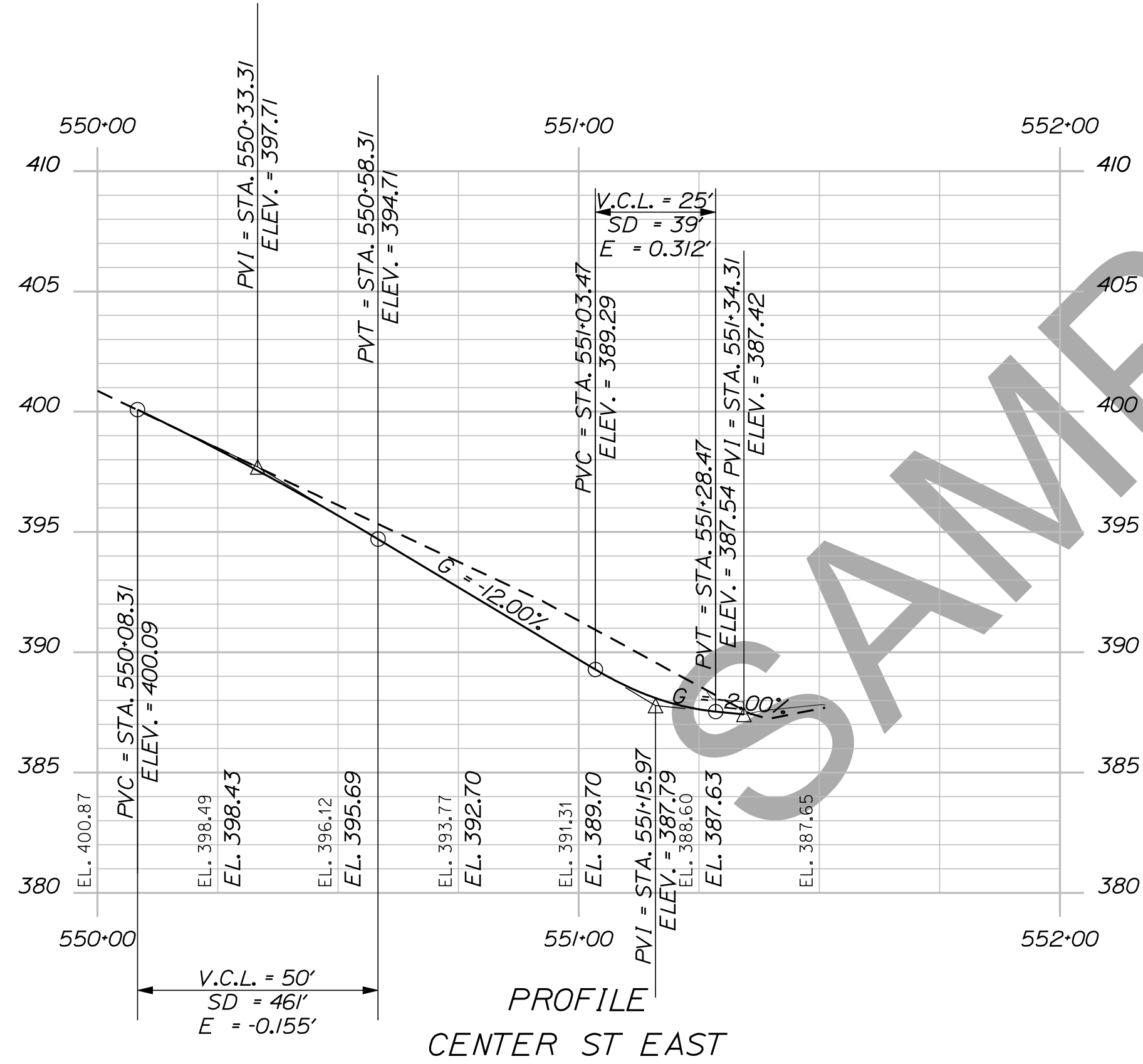

SHEET NUMBER

31

OF 141

DEXTER ROUTE 7 PROFILE

DESIGN-DETAILED	PROJ. MANAGER	ERNEST MARTIN	BY	DATE
CHECKED-REVIEWED	TRAVIS WOLFE			
DESIGNS DET AILED				
DESIGNS DET AILED				
REVISIONS 1				
REVISIONS 2				
REVISIONS 3				
REVISIONS 4				
FIELD CHANGES				

SIGNATURE	P.E. NUMBER	DATE

STATE OF MAINE
DEPARTMENT OF TRANSPORTATION
018246.00
WIN
18246.00
HIGHWAY PLANS

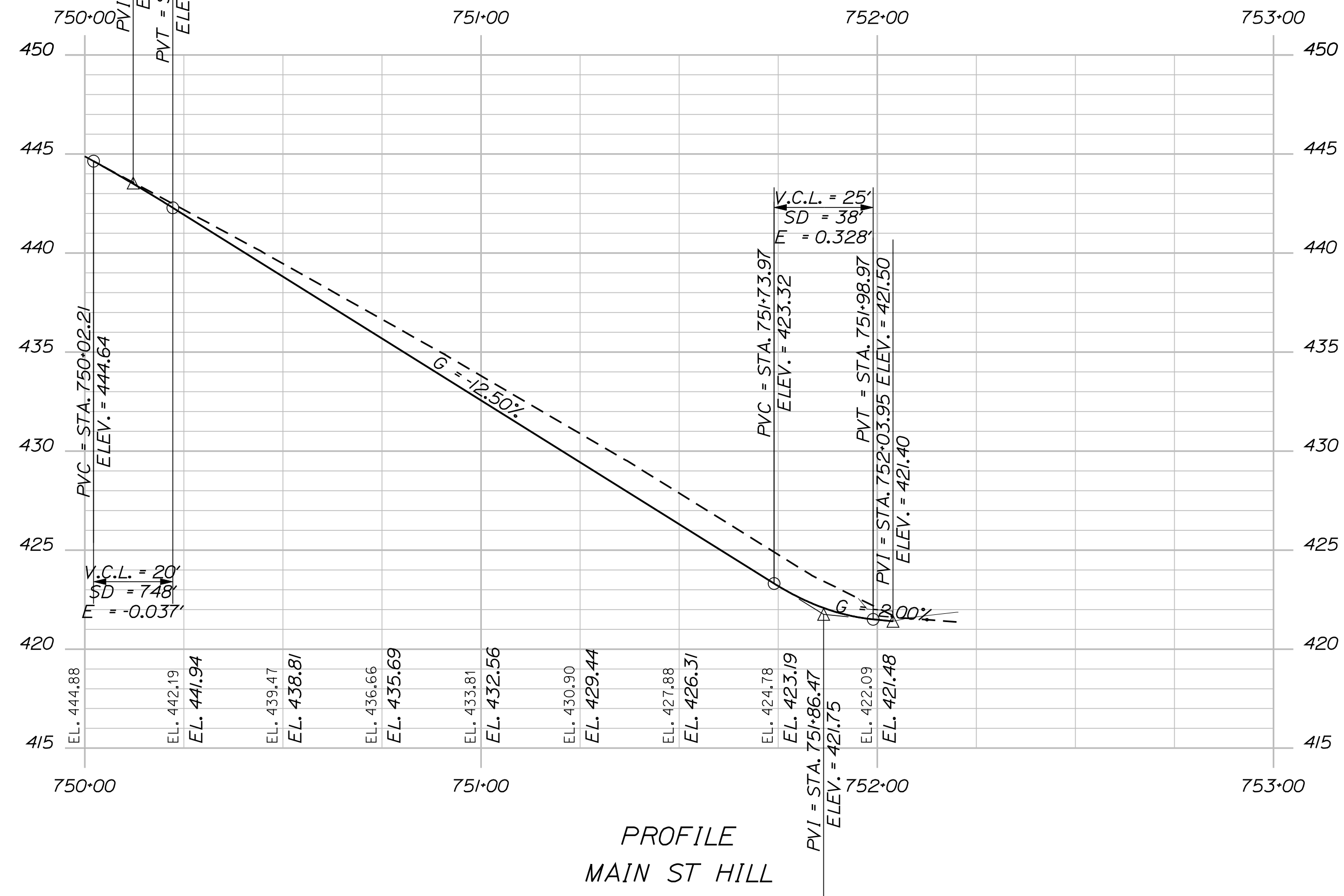
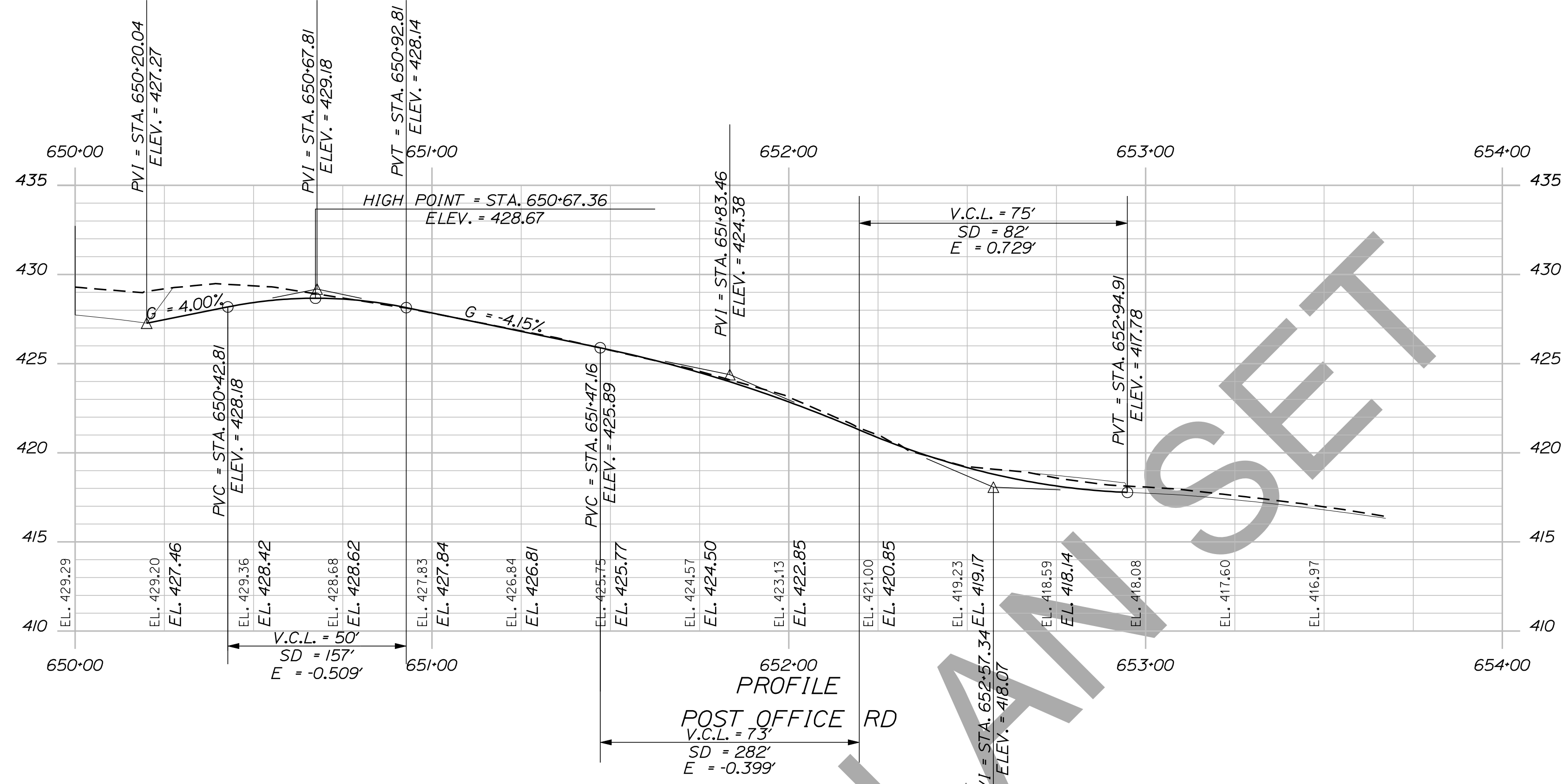
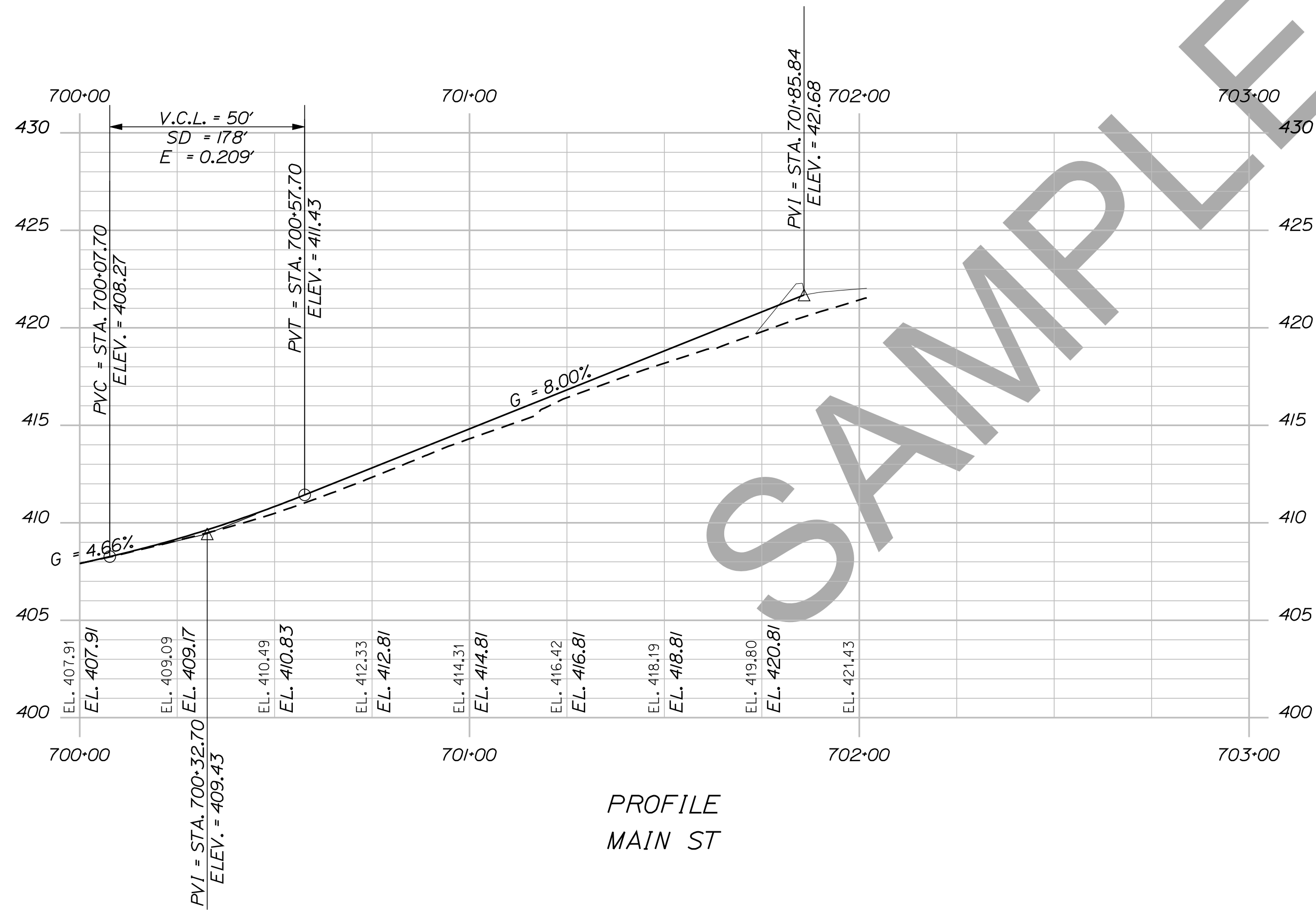

STATE OF MAINE
DEPARTMENT OF TRANSPORTATION

018246.00
WIN
18246.00
HIGHWAY PLANS

PROJ. MANAGER	BY	DATE
ERNEST MARTIN	TRAVIS WOLFE	
CHECKED-REVIEWED		
DESIGNED-DETAILED		
DESIGNS DETAILED		
REVISIONS 1		
REVISIONS 2		
REVISIONS 3		
REVISIONS 4		
FIELD CHANGES		

DEXTER
ROUTE 7
PROFILE

SHEET NUMBER
32
OF 141

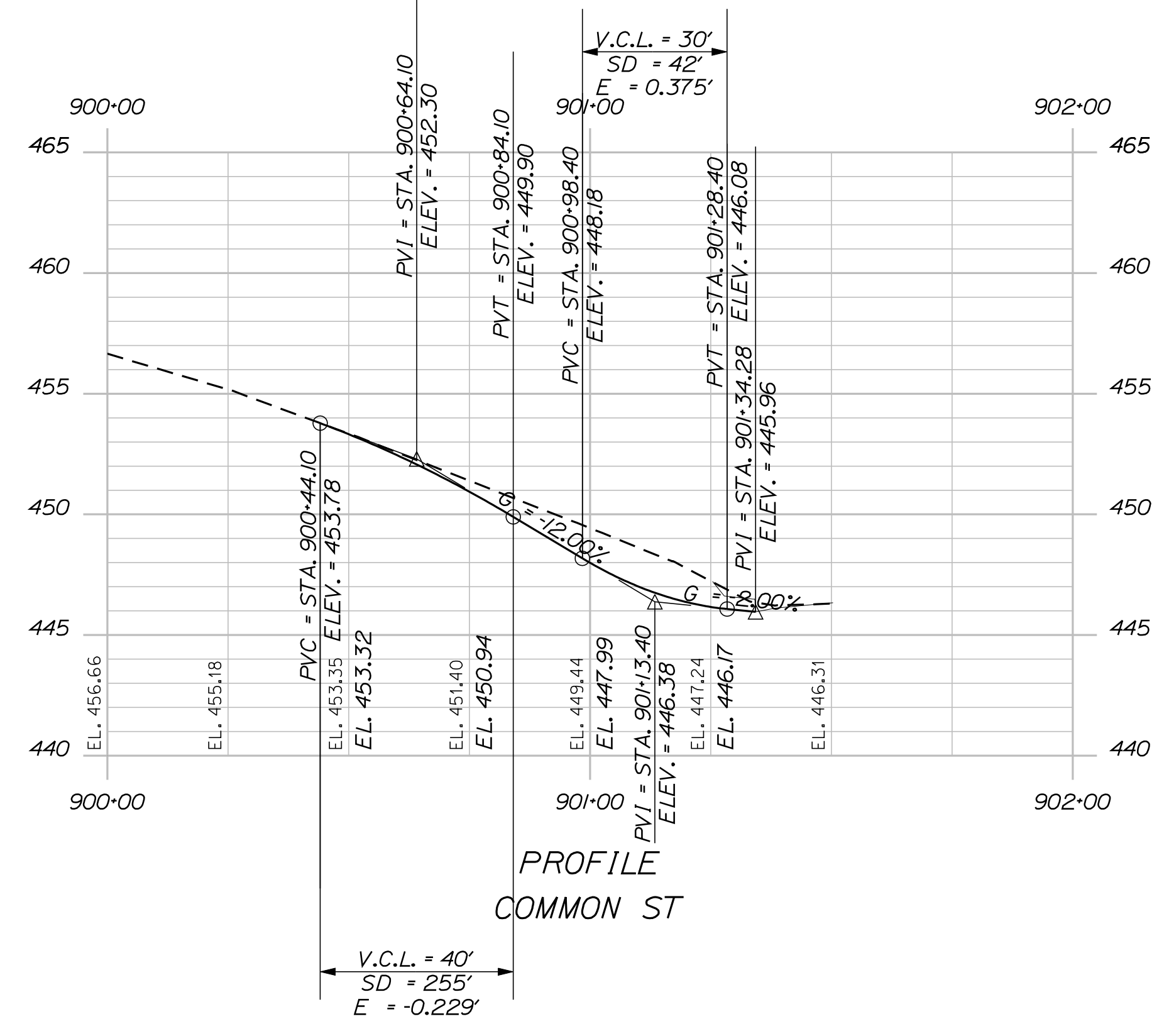
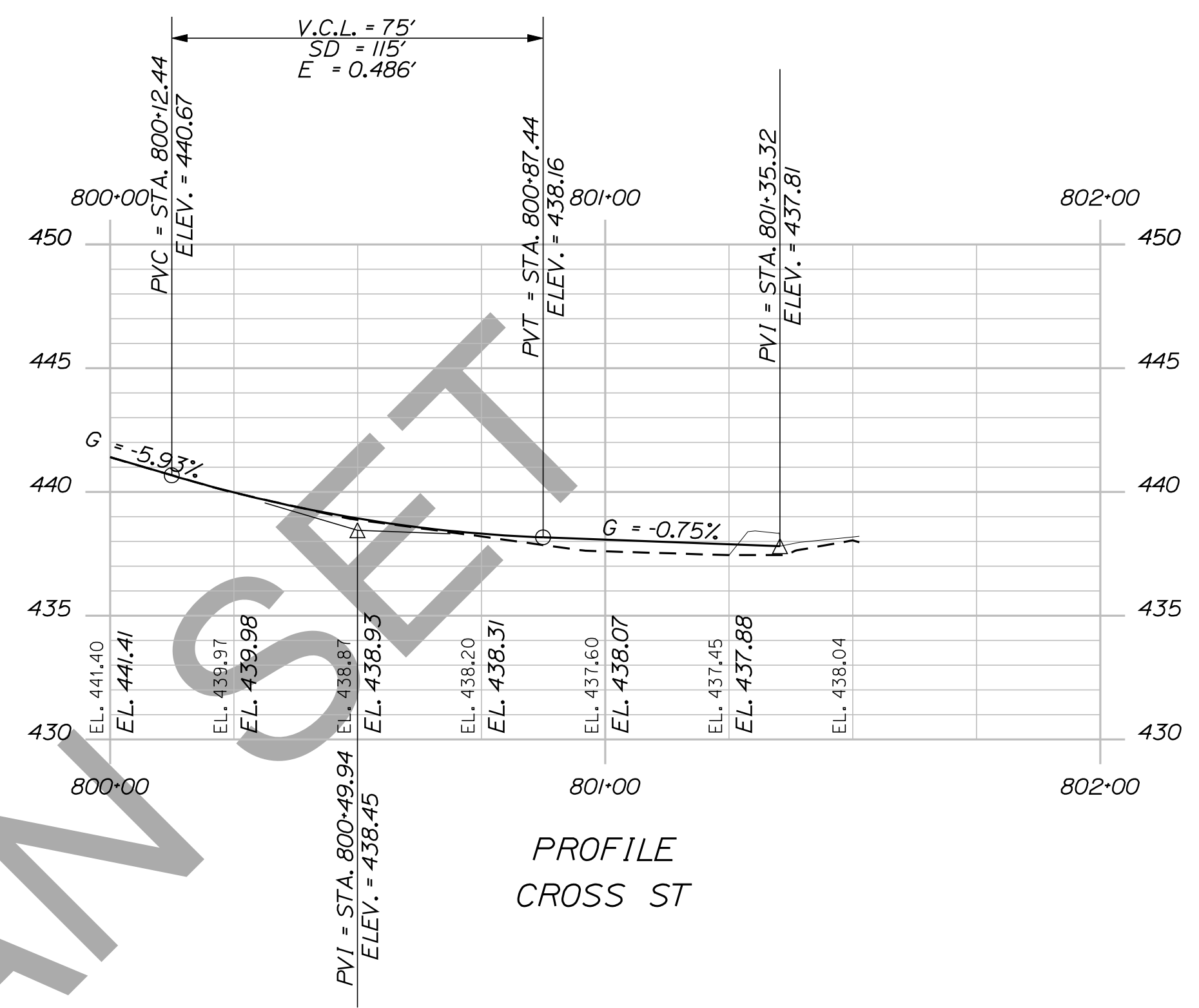
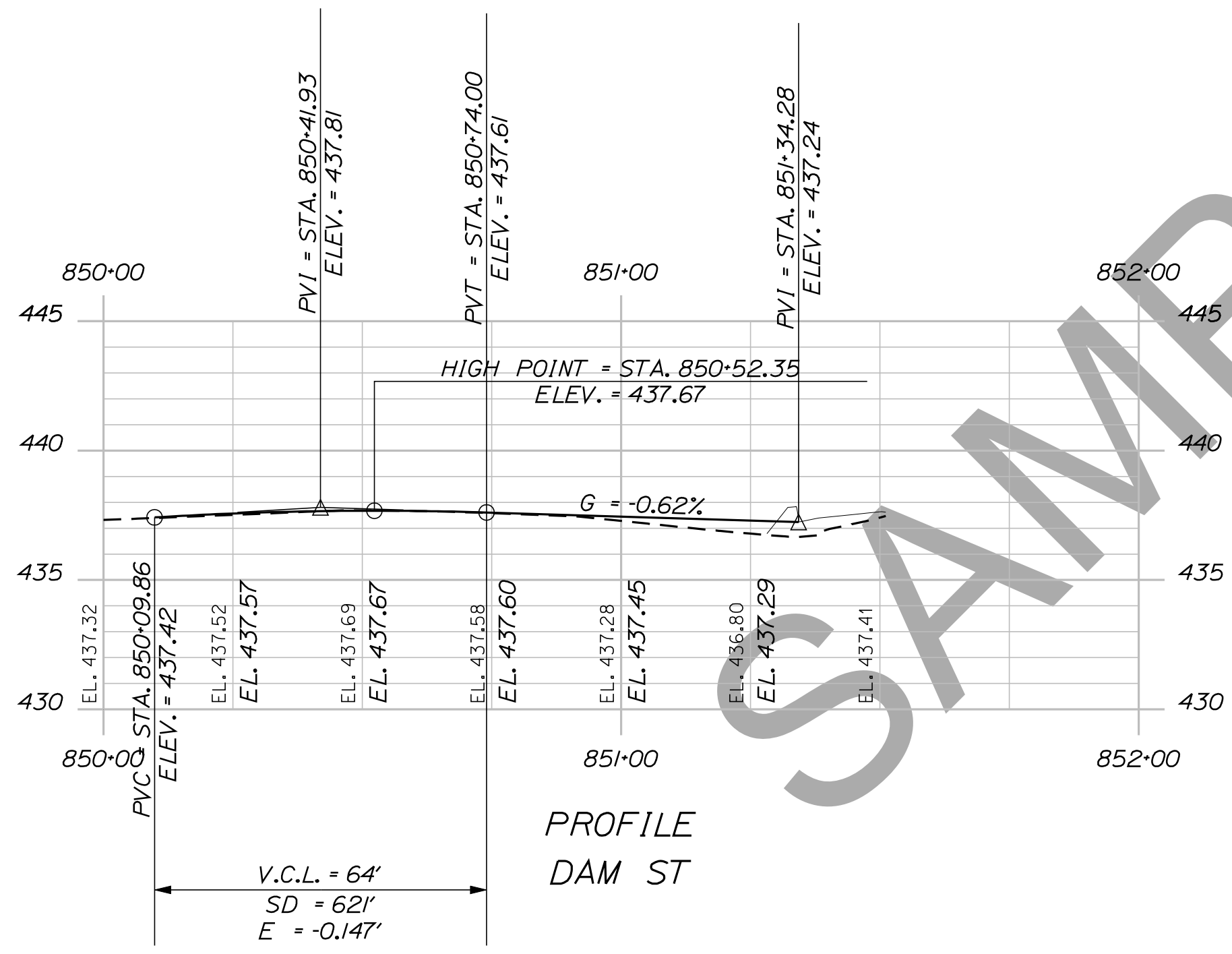
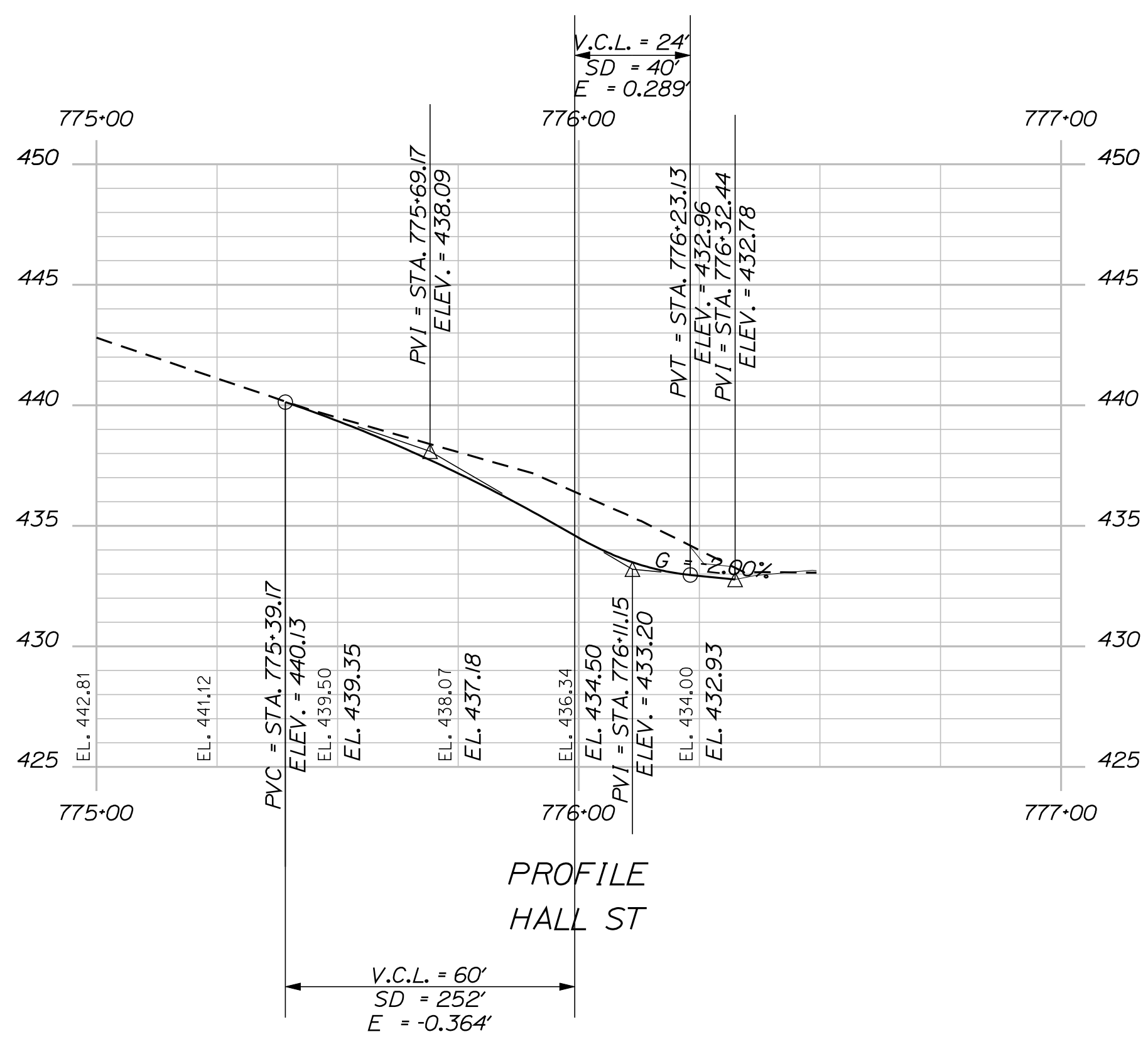

STATE OF MAINE DEPARTMENT OF TRANSPORTATION		SHEET NUMBER 33 OF 141	
018246.00		WIN 18246.00	
HIGHWAY PLANS			
PROJ. MANAGER ERNEST MARTIN	BY TRAVIS WOLFE	DATE	
DESIGN-REVIEWED	CHECKED	SIGNATURE	
DESIGNS-DETAILED	DESIGNS-DETAILED	P.E. NUMBER	
REVISIONS 1	REVISIONS 1	DATE	
REVISIONS 2	REVISIONS 2		
REVISIONS 3	REVISIONS 3		
REVISIONS 4	REVISIONS 4		
FIELD CHANGES			

Filename: ... \025_xsect_12+00_001.dgn

Division: HIGHWAY

Username: atlee,mousseau

Date: 12/10/2013

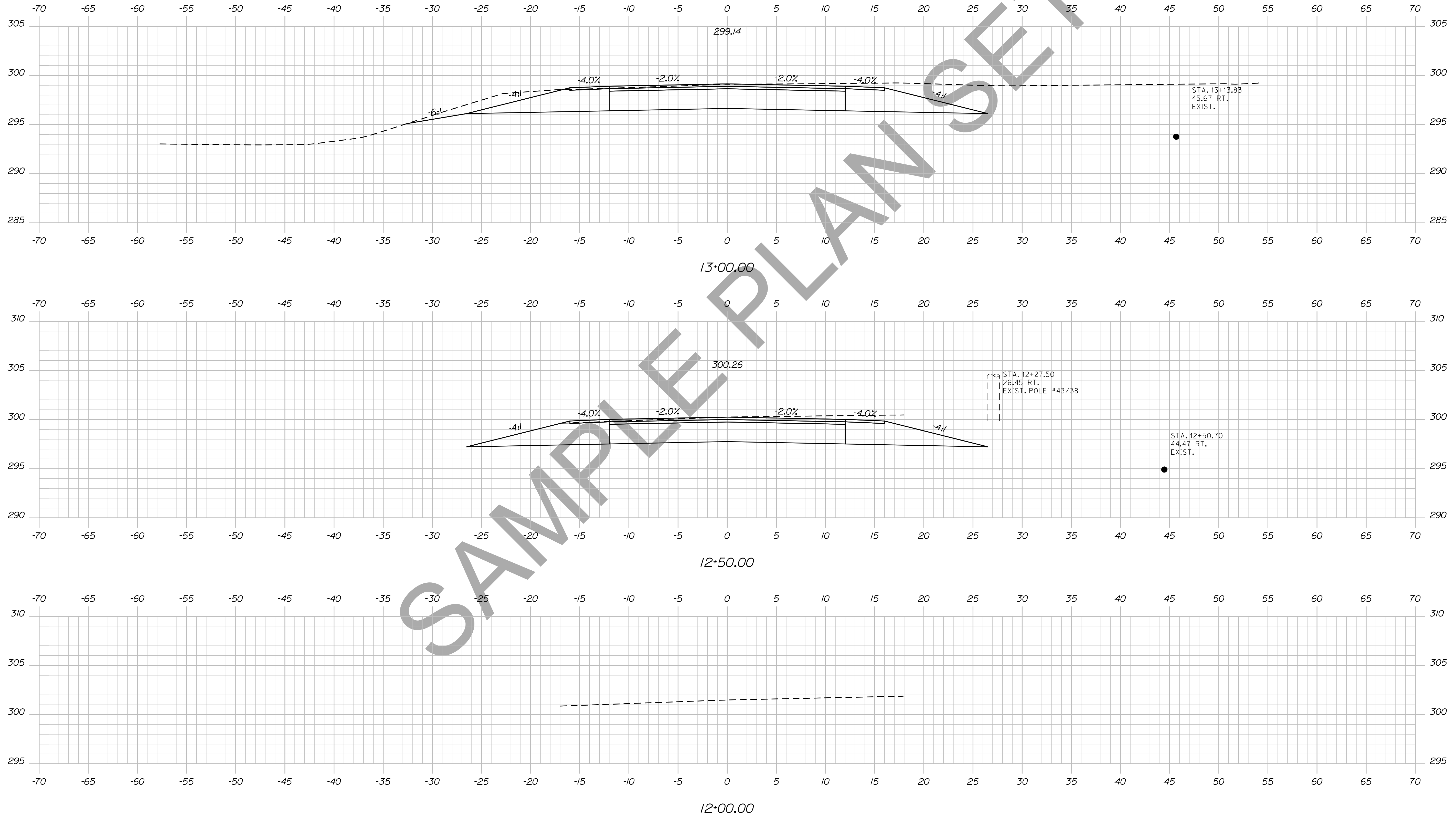

STATE OF MAINE
DEPARTMENT OF TRANSPORTATION

018246.00
WIN
PIN 18246.00
HIGHWAY PLANS

PROJ. MANAGER	BY	DATE	SIGNATURE
CHECKED-REVIEWED	DESIGNER	DATE	
DESIGN DET AILED	DESIGNER	DATE	
DESIGN DET AILED	DESIGNER	DATE	
REVISIONS 1	REVISION	DATE	
REVISIONS 2	REVISION	DATE	
REVISIONS 3	REVISION	DATE	
REVISIONS 4	REVISION	DATE	
FIELD CHANGES	FIELD CHANGES	FIELD CHANGES	

DEXTER
ROUTE 7
CROSS SECTIONS

SHEET NUMBER
25
OF 15

Date: 12/10/2013

Username: atlee.mousseau

Division: HIGHWAY

Filename: ... \026_xsect_13+02_002.dgn

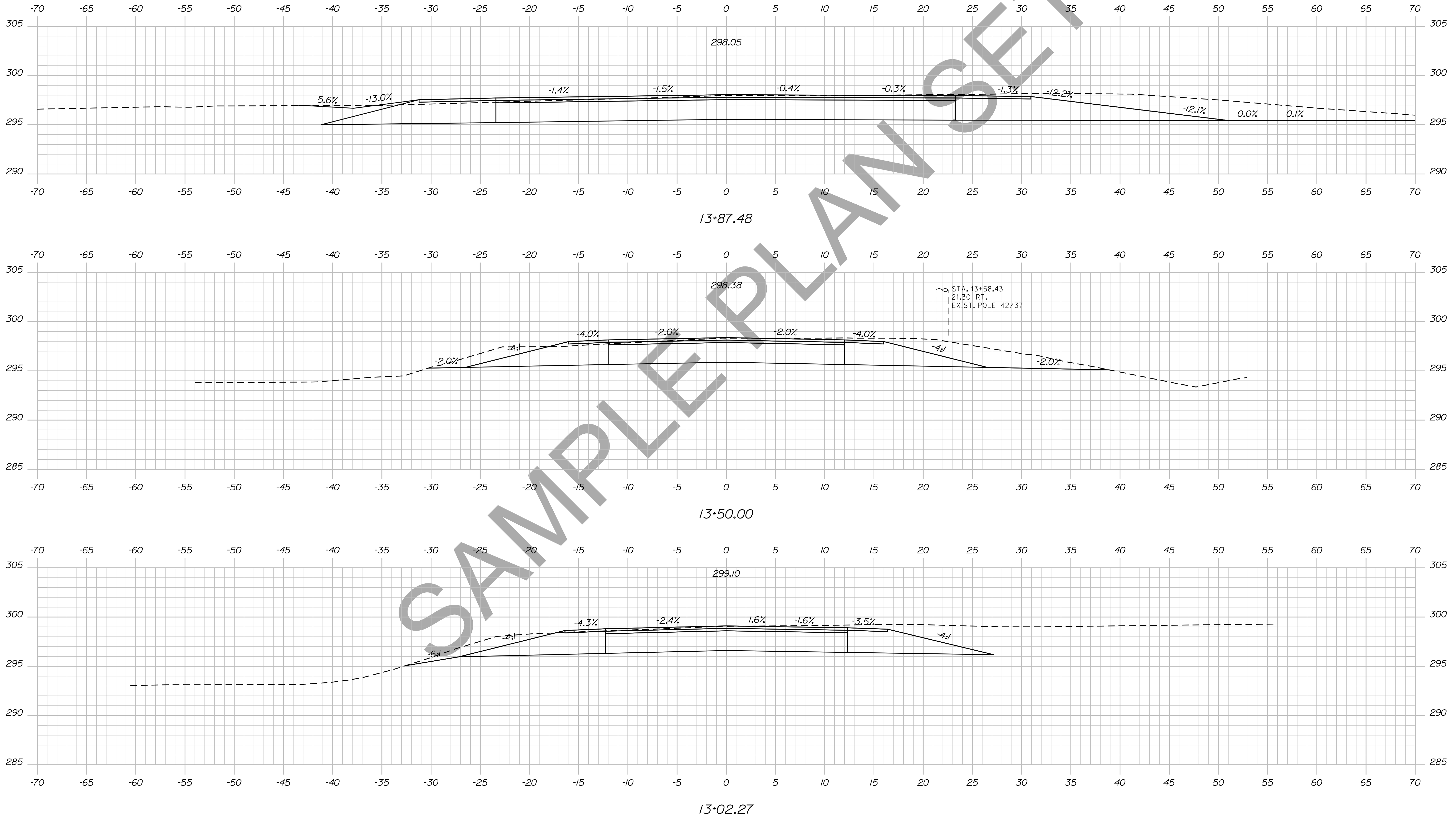

STATE OF MAINE
DEPARTMENT OF TRANSPORTATION
018246.00
WIN
PIN 18246.00
HIGHWAY PLANS

SIGNATURE
P.E. NUMBER
DATE

PROJ. MANAGER	BY	DATE
DESIGN-DETAILED	DESIGNER	DATE
CHECKED-REVIEWED	CHECKER	DATE
DESIGNS DET AILED	DESIGNER	DATE
DESIGNS DET AILED	DESIGNER	DATE
REVISIONS 1	DESIGNER	DATE
REVISIONS 2	DESIGNER	DATE
REVISIONS 3	DESIGNER	DATE
REVISIONS 4	DESIGNER	DATE
FIELD CHANGES	FIELD	DATE

DEXTER
ROUTE 7
CROSS SECTIONS

SHEET NUMBER
26
OF 15

Filename: ... \027_xsect_14+00_003.dgn

Division: HIGHWAY

Username: atlee.mousseau

Date: 12/10/2013

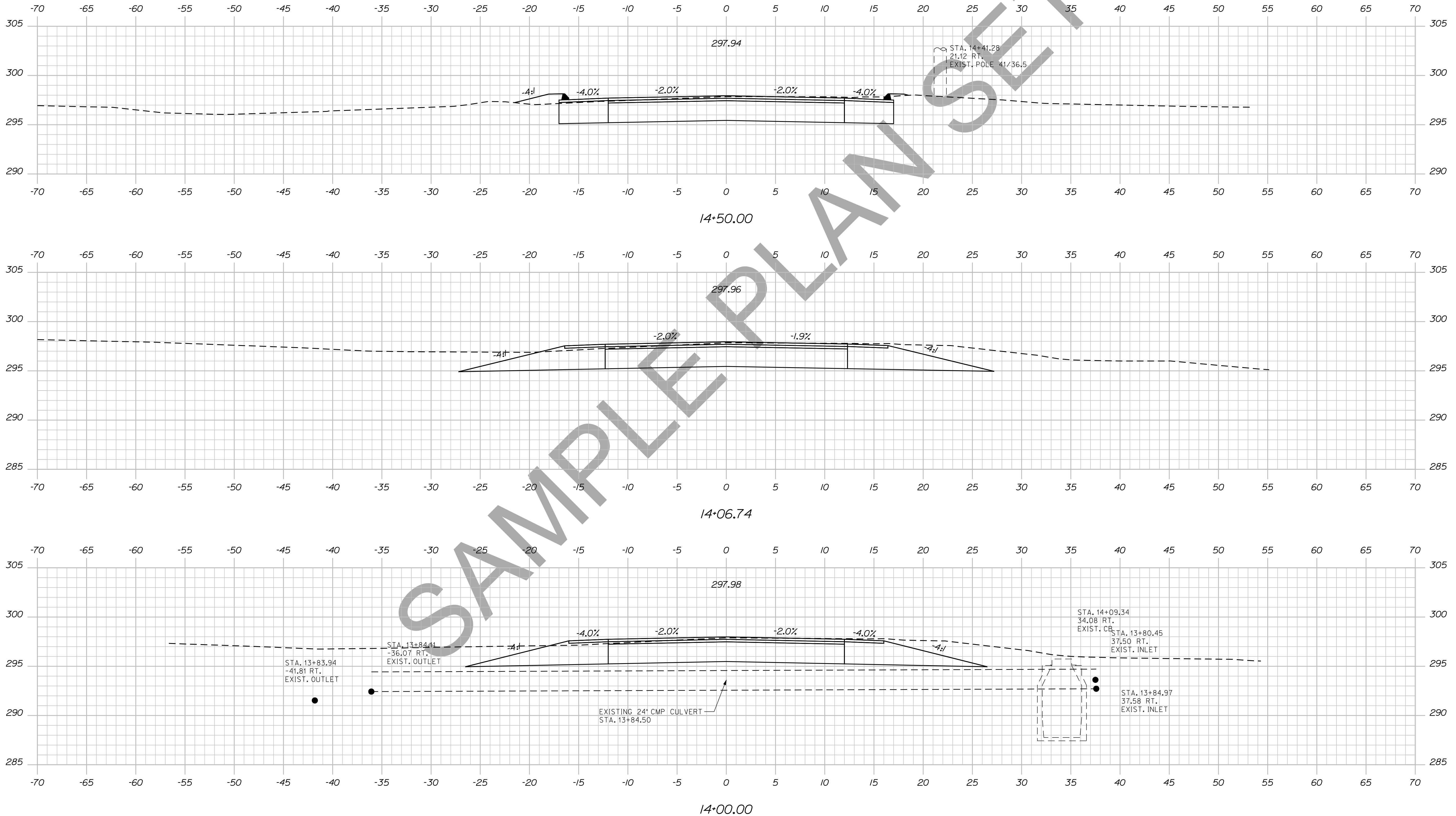

STATE OF MAINE
DEPARTMENT OF TRANSPORTATION
018246.00
WIN
PIN 18246.00
HIGHWAY PLANS

PROJ. MANAGER	BY	DATE
DESIGN-DETAILED	DESIGNER	DATE
CHECKED-REVIEWED	CHECKER	DATE
DESIGN-DETAILED	DESIGNER	DATE
DESIGN-DETAILED	DESIGNER	DATE
REVISIONS 1	REVISION	DATE
REVISIONS 2	REVISION	DATE
REVISIONS 3	REVISION	DATE
REVISIONS 4	REVISION	DATE
FIELD CHANGES	FIELD	DATE

DEXTER
ROUTE 7
CROSS SECTIONS

SHEET NUMBER
27
OF 15

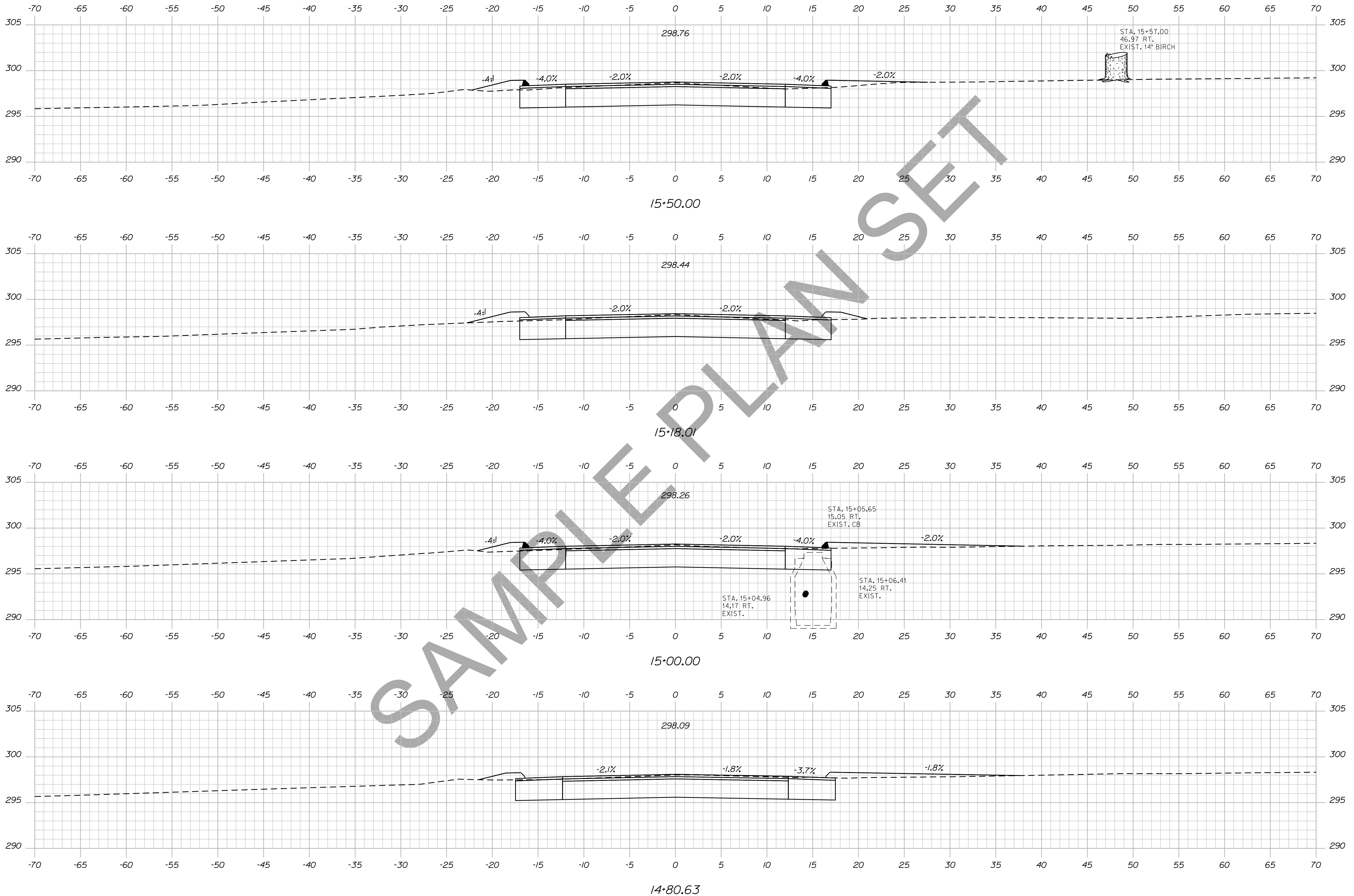

STATE OF MAINE DEPARTMENT OF TRANSPORTATION		018246.00		WIN PIN 18246.00		HIGHWAY PLANS	
DEXTER ROUTE 7		CROSS SECTIONS		SHEET NUMBER 28 OF 15		Sta. 14+80.63 to Sta. 15+50.00	
PROJ. MANAGER	DESIGN-DETAILED	CHECKED-REVIEWED	DESIGNS DET. TAILED	DESIGNS DET. TAILED	REVISIONS 1	REVISIONS 2	REVISIONS 3
BY	DATE	SIGNATURE	P.E. NUMBER	DATE			
FIELD CHANGES							

Username: atlee.mousseau Date: 12/10/2013

Division: HIGHWAY

Filename: ... \029_xsect_15+88_005.dgn

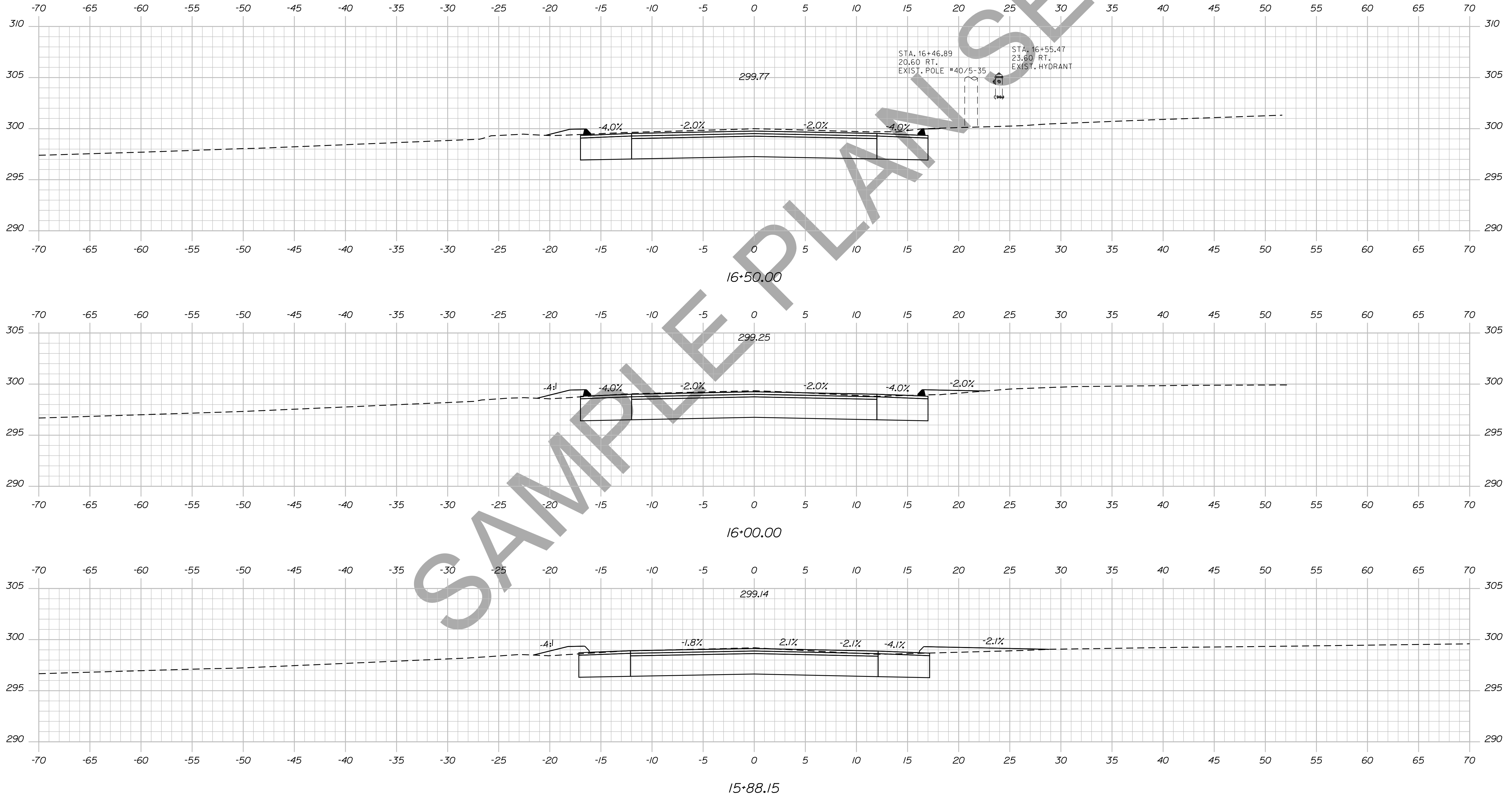

STATE OF MAINE
DEPARTMENT OF TRANSPORTATION
018246.00
WIN
PIN 18246.00
HIGHWAY PLANS

PROJ. MANAGER	DESIGN-DETAILED	CHECKED-REVIEWED	DESIGNS DET. TAILED	REVISIONS 1	REVISIONS 2	REVISIONS 3	REVISIONS 4	FIELD CHANGES

BY	DATE	SIGNATURE

P.E. NUMBER	DATE

DEXTER
ROUTE 7
CROSS SECTIONS

SHEET NUMBER
29
OF 15

Date: 12/10/2013

Username: atlee.mousseau

Division: HIGHWAY

Filename: ... \030_xsect_17+00_006.dgn

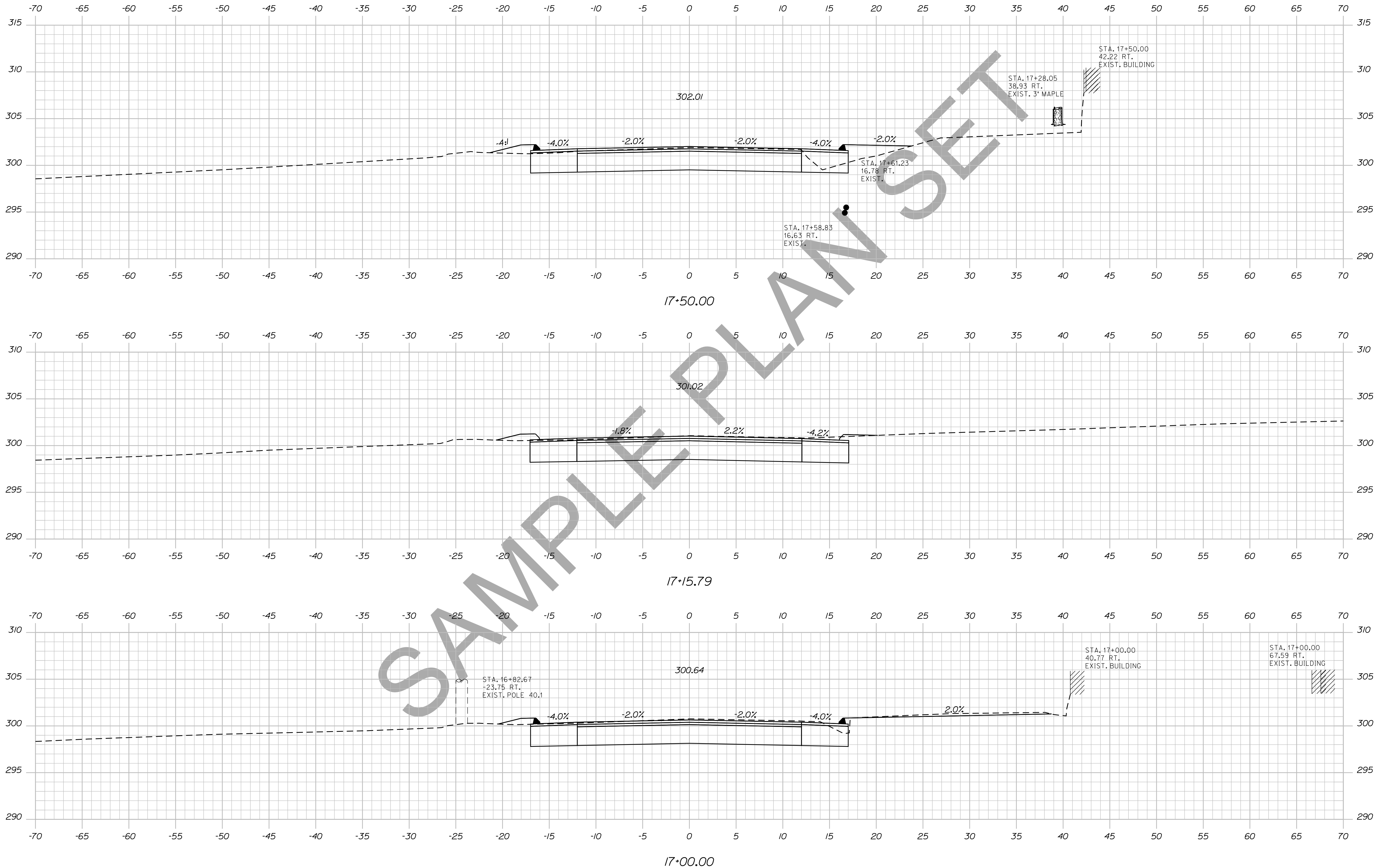

STATE OF MAINE
DEPARTMENT OF TRANSPORTATION
018246.00
WIN
PIN 18246.00
HIGHWAY PLANS

PROJ. MANAGER	BY	DATE	SIGNATURE
DESIGN-DETAILED	DESIGNER	DATE	
CHECKED-REVIEWED	CHECKER	DATE	
DESIGN-DETAILED	DESIGNER	DATE	
DESIGN-DETAILED	DESIGNER	DATE	
REVISIONS 1	DESIGNER	DATE	
REVISIONS 2	DESIGNER	DATE	
REVISIONS 3	DESIGNER	DATE	
REVISIONS 4	DESIGNER	DATE	
FIELD CHANGES	DESIGNER	DATE	

DEXTER
ROUTE 7
CROSS SECTIONS

SHEET NUMBER
30
OF 15

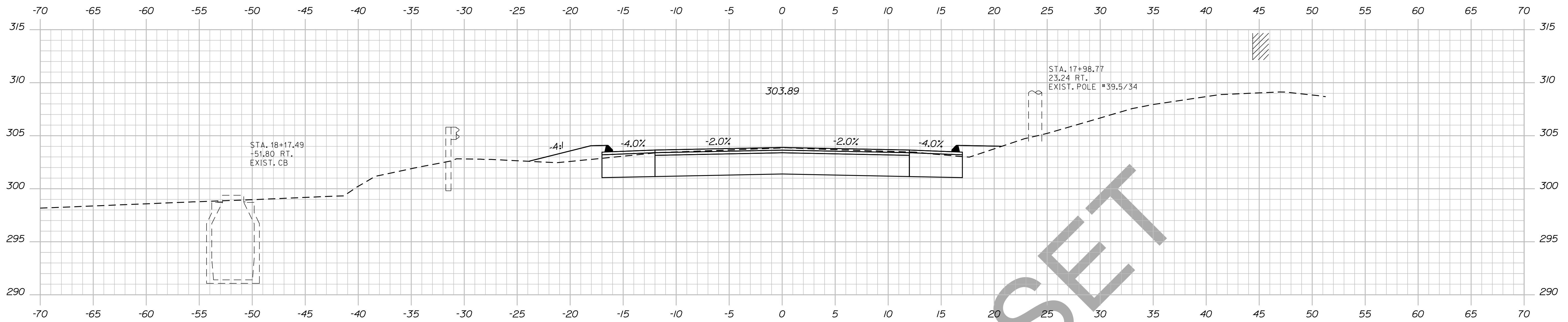

18+00.00

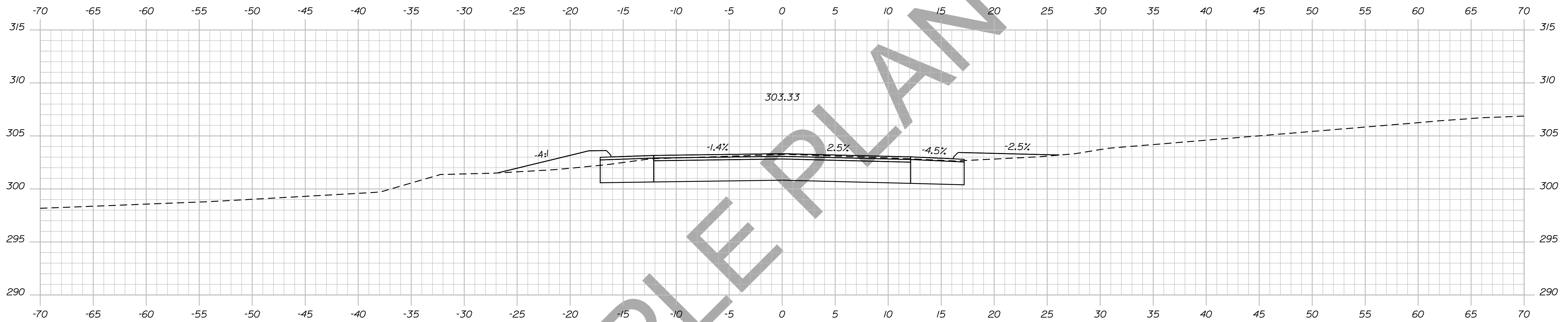

17+86.47

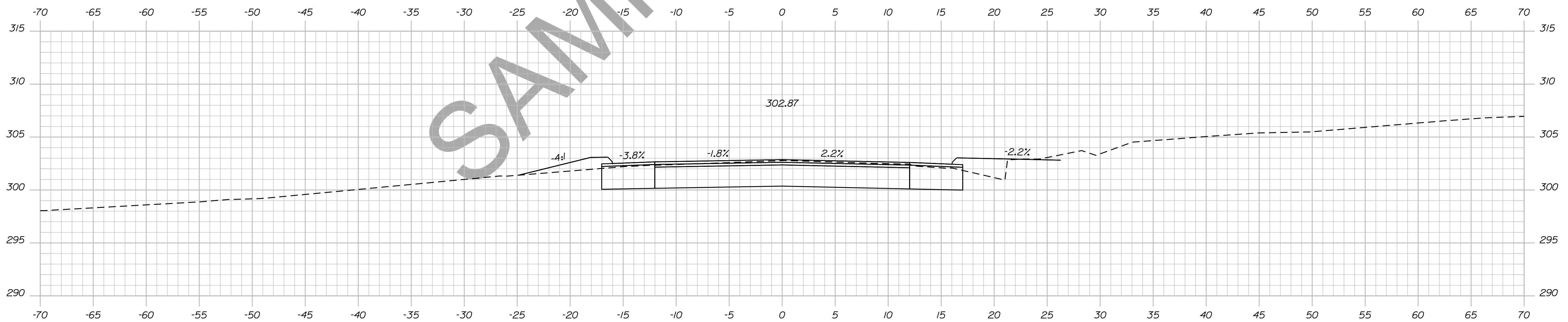

17+74.48

STATE OF MAINE
DEPARTMENT OF TRANSPORTATION

018246-00

WIN

PIN 18246.00

HIGHWAY PLANS

SIGNATURE

P.E. NUMBER

DATE

DATE

BY

PROJ. MANAGER

CHECKED-REVIEWED

DESIGNS DET AILED

DESIGNS DET AILED

DESIGNS DET AILED

DESIGNS DET AILED

DESIGNS DET AILED

DESIGNS DET AILED

DESIGNS DET AILED

DESIGNS DET AILED

DESIGNS DET AILED

DESIGNS DET AILED

DESIGNS DET AILED

DESIGNS DET AILED

DESIGNS DET AILED

DESIGNS DET AILED

DESIGNS DET AILED

DESIGNS DET AILED

DESIGNS DET AILED

DESIGNS DET AILED

DESIGNS DET AILED

DESIGNS DET AILED

DESIGNS DET AILED

DESIGNS DET AILED

DEXTER
ROUTE 7

CROSS SECTIONS

SHEET NUMBER

31

OF 15

Date: 12/10/2013

Username: atlee.mousseau

Division: HIGHWAY

Filename: ... \032_xsect_18+50_008.dgn

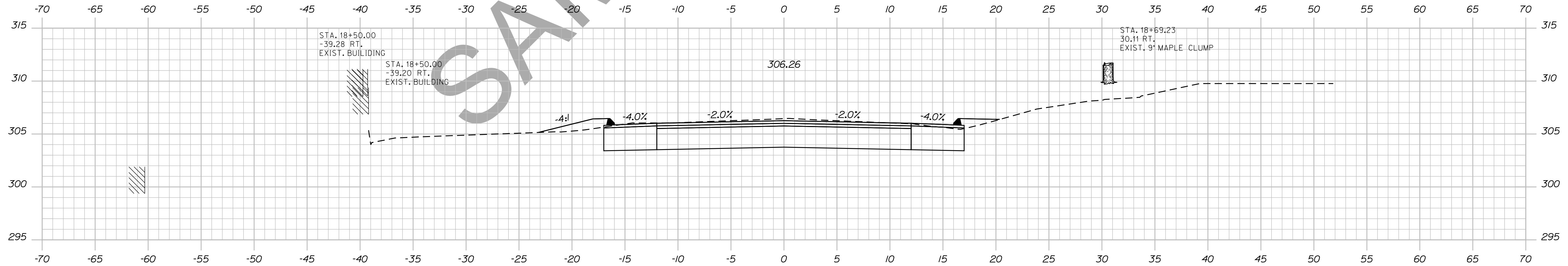
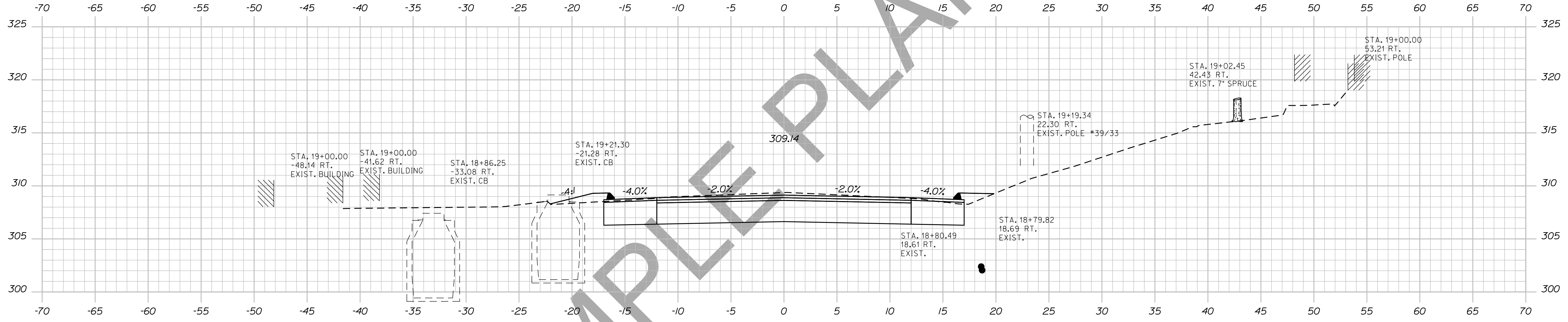
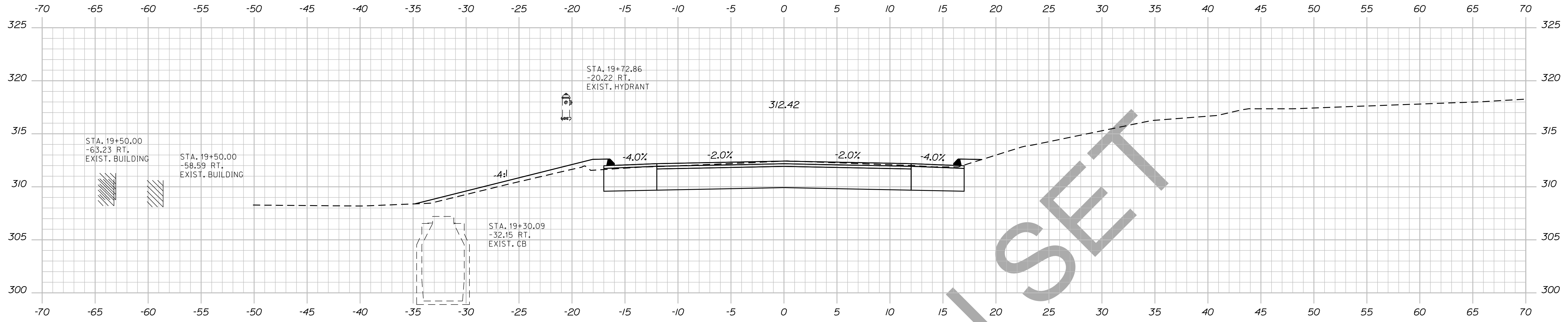

STATE OF MAINE
DEPARTMENT OF TRANSPORTATION
018246.00
WIN
PIN 18246.00
HIGHWAY PLANS

PROJ. MANAGER	DESIGNER	CHECKED	DATE	SIGNATURE	P.E. NUMBER	DATE

DEXTER
ROUTE 7
CROSS SECTIONS

SHEET NUMBER
32
OF 15

Date: 12/10/2013

Username: atlee.mousseau

Division: HIGHWAY

Filename: ... \033_xsect_19+96_009.dgn

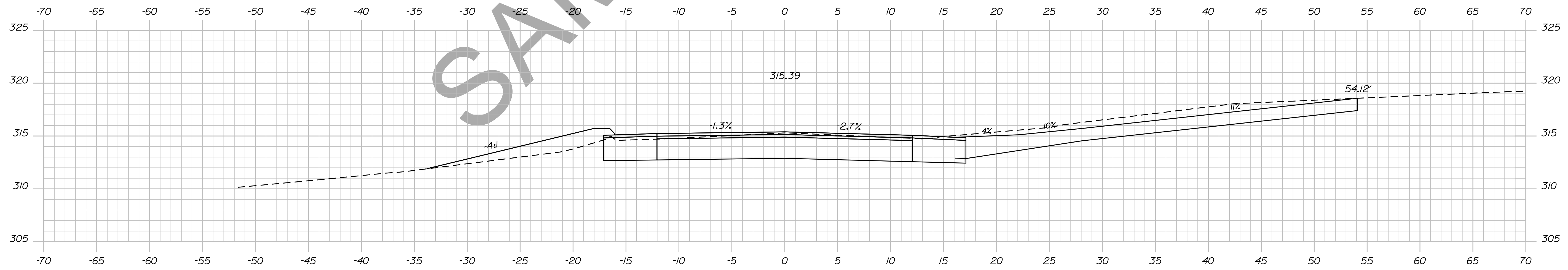
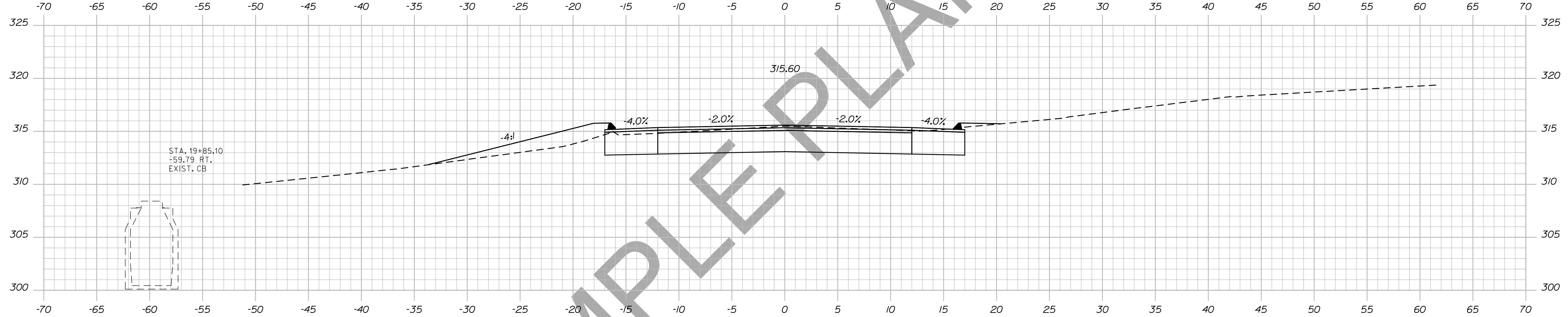
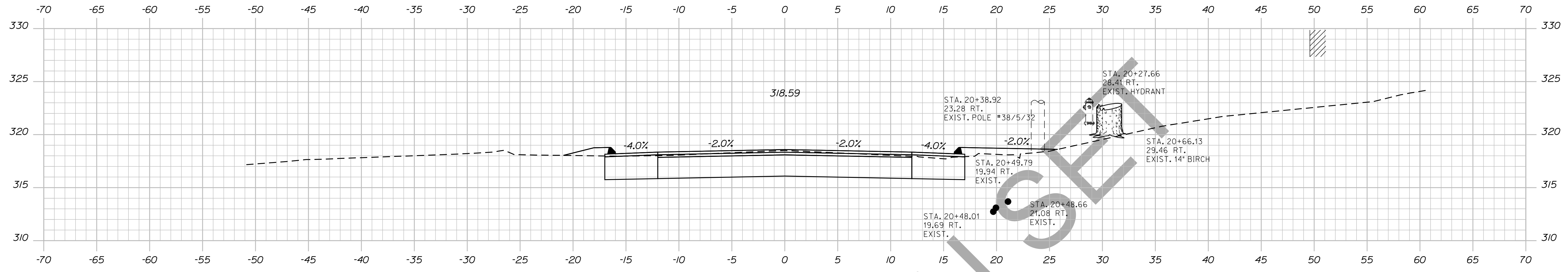

STATE OF MAINE	
DEPARTMENT OF TRANSPORTATION	
018246.00	
WIN PIN 18246.00	
HIGHWAY PLANS	
PROJ. MANAGER	DATE
DESIGNER	BY
CHECKED	DATE
DESIGN REVIEWED	DESIGNED
DESIGNED	PROPOSED
REVISIONS 1	REVISIONS 2
REVISIONS 2	REVISIONS 3
REVISIONS 3	REVISIONS 4
REVISIONS 4	FIELD CHANGES
SIGNATURE	
P.E. NUMBER	
DATE	
DEXTER ROUTE 7	
CROSS SECTIONS	
SHEET NUMBER	
33	
OF 15	

Date: 12/10/2013

Username: atlee.mousseau

Division: HIGHWAY

Filename: ... \034_xsect_20-71_010.dgn

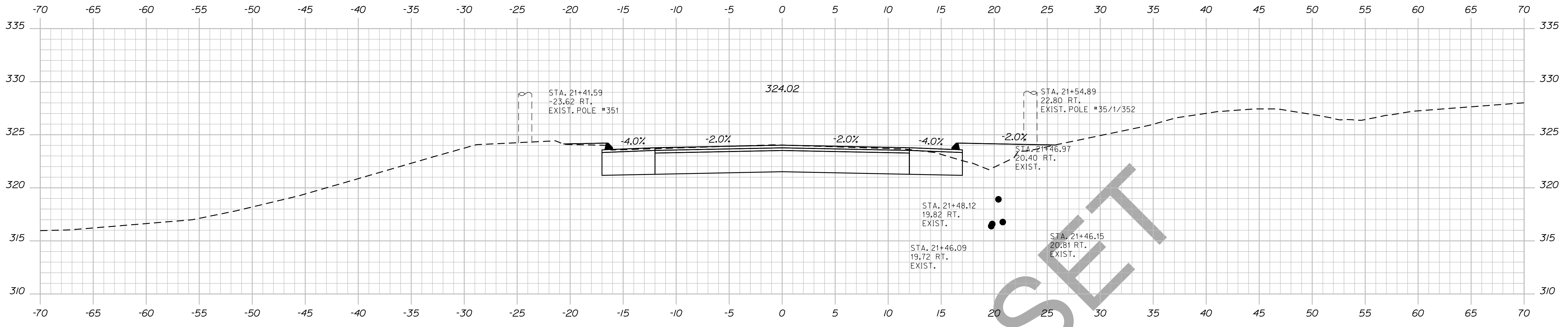

21+50.00

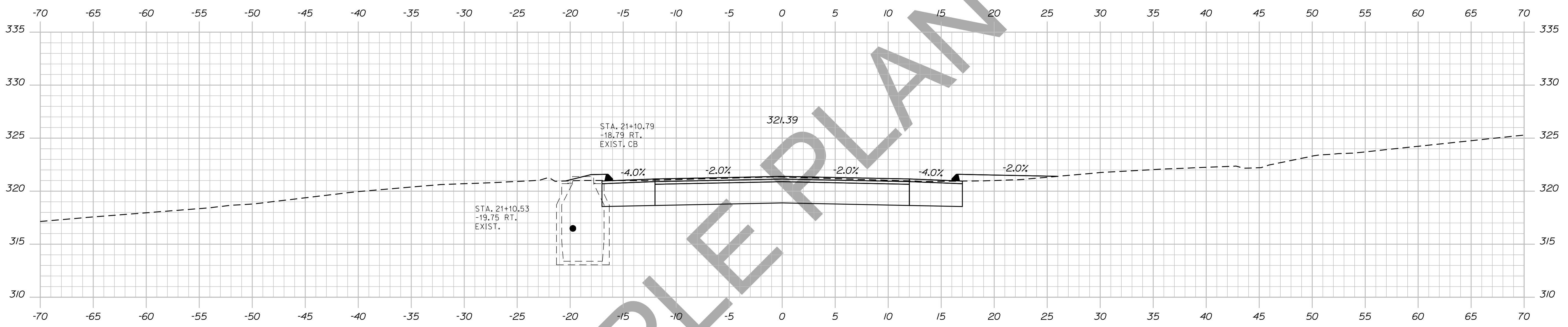

21+00.00

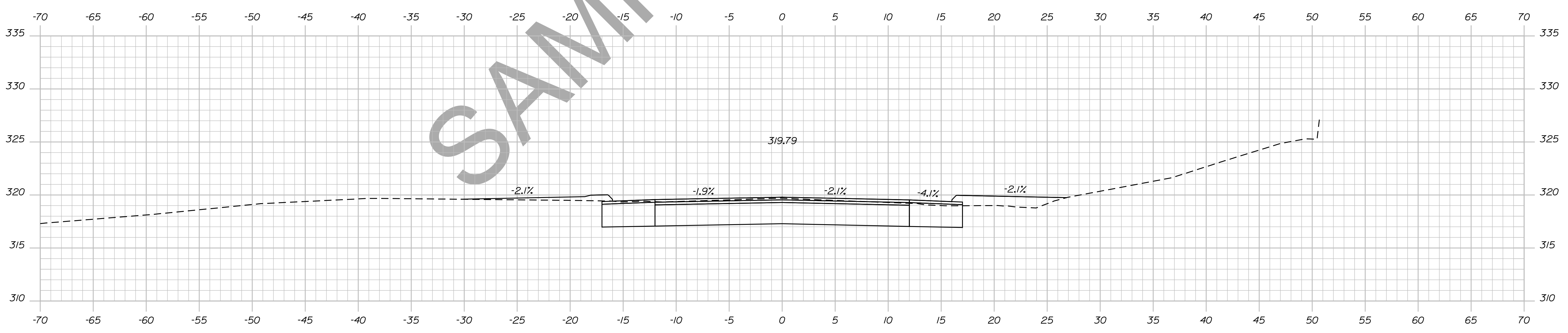

20+71.08

STATE OF MAINE
DEPARTMENT OF TRANSPORTATION
018246.00
WIN
PIN 18246.00
HIGHWAY PLANS

PROJ. MANAGER	DESIGN-DETAILED	CHECKED-REVIEWED	DESIGN-DETAILED	DESIGN-DETAILED	DESIGN-DETAILED	REVISIONS 1	REVISIONS 2	REVISIONS 3	REVISIONS 4	FIELD CHANGES	PROJ. MANAGER	BY	DATE	SIGNATURE	P.E. NUMBER	DATE

DEXTER
ROUTE 7
CROSS SECTIONS

SHEET NUMBER
34
OF 15

Date: 12/10/2013

Username: atlee.mousseau

Division: HIGHWAY

Filename: ... \035_xsect_22+00_01.dgn

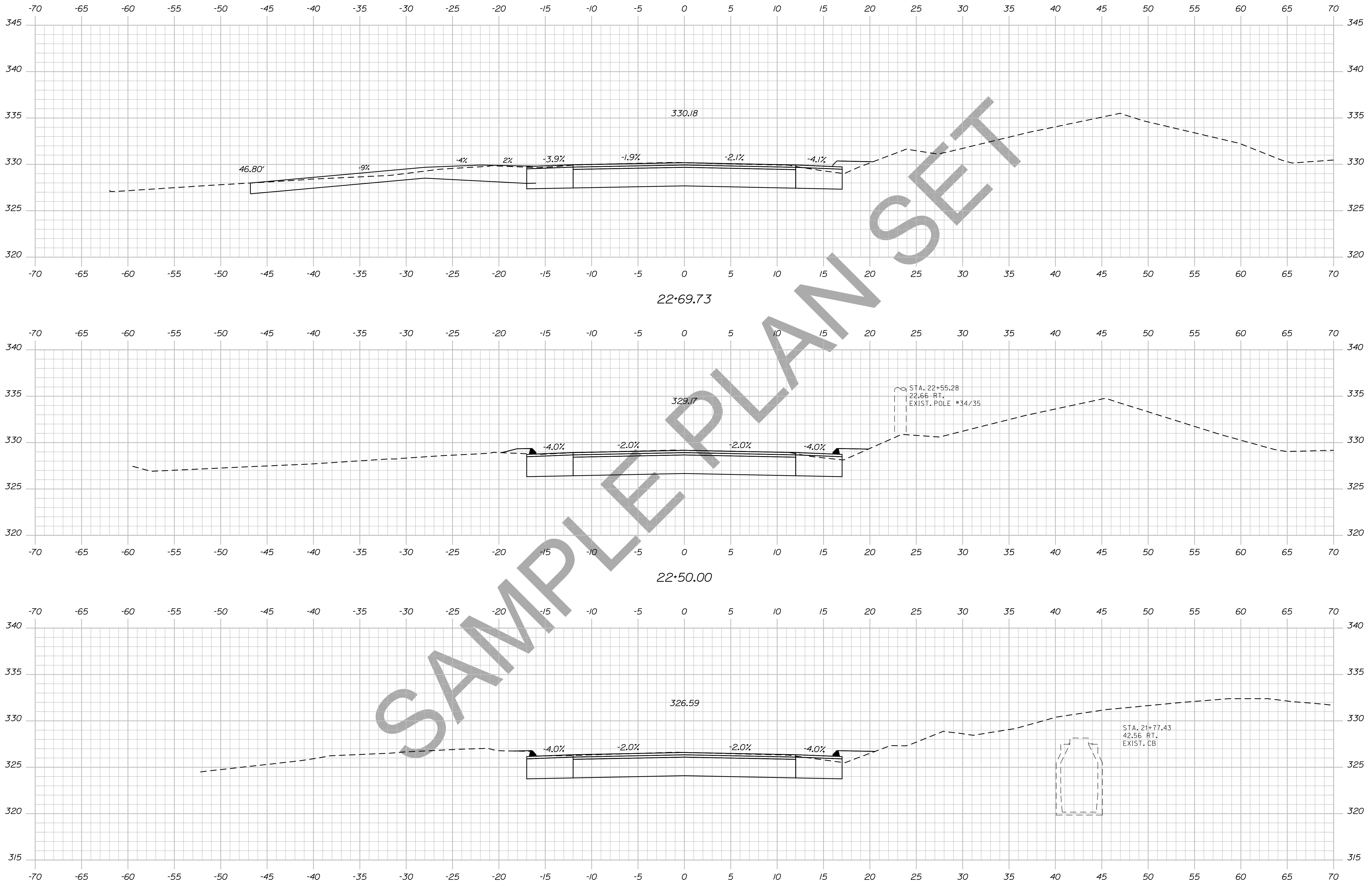

STATE OF MAINE
DEPARTMENT OF TRANSPORTATION
018246.00
WIN
PIN 18246.00
HIGHWAY PLANS

PROJ. MANAGER	DESIGN-DETAILED	CHECKED-REVIEWED	DESIGN-DETAILED	DESIGN-DETAILED	REVISIONS 1	REVISIONS 2	REVISIONS 3	REVISIONS 4	FIELD CHANGES	DATE	BY	DATE	SIGNATURE	P.E. NUMBER	DATE

DEXTER
ROUTE 7
CROSS SECTIONS

SHEET NUMBER
35
OF 15

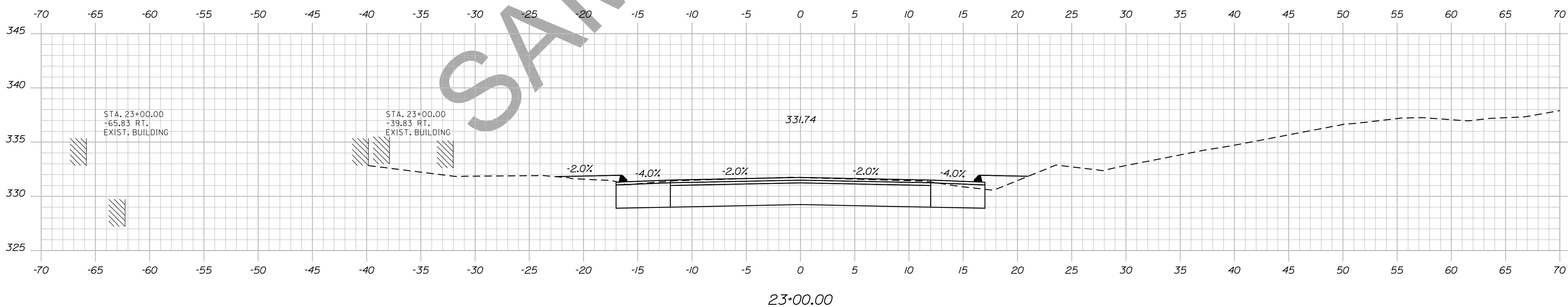
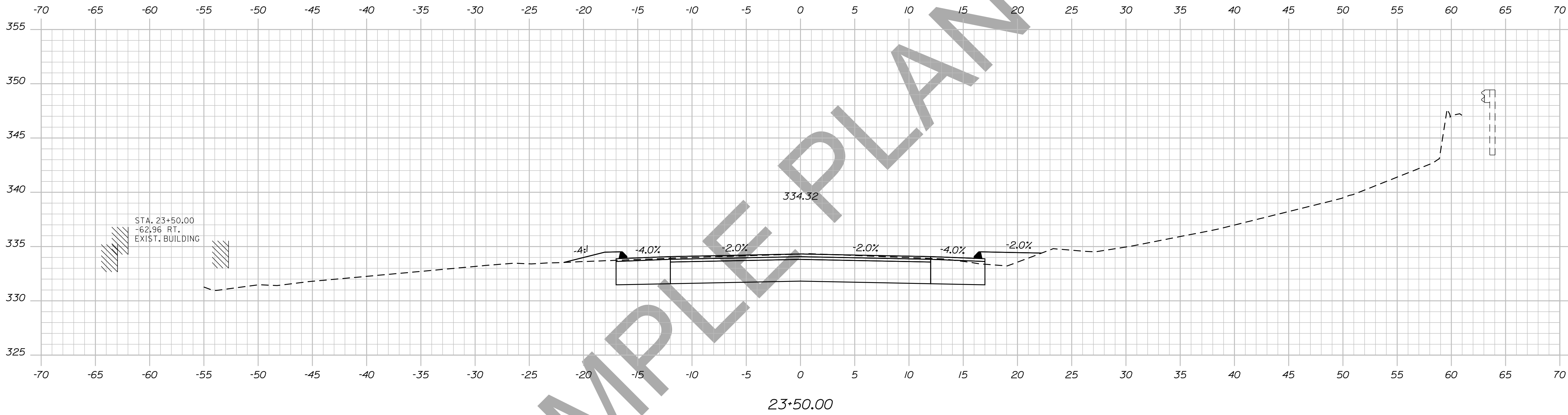

STATE OF MAINE
DEPARTMENT OF TRANSPORTATION

018246.00

WIN

PIN 18246.00

HIGHWAY PLANS

PROJ. MANAGER	DESIGNER	CHECKER	DATE	BY	DATE

DEXTER
ROUTE 7
CROSS SECTIONS

SHEET NUMBER

36

OF 15

Filename: ... \037_xsect_24+00_013.dgn

Division: HIGHWAY

Username: atlee,mousseau

Date: 12/10/2013

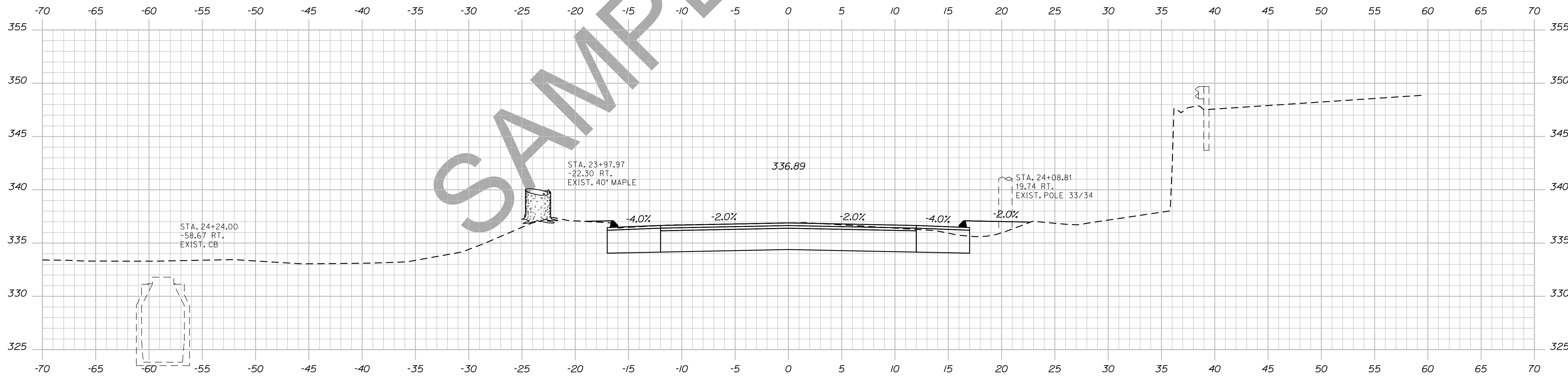
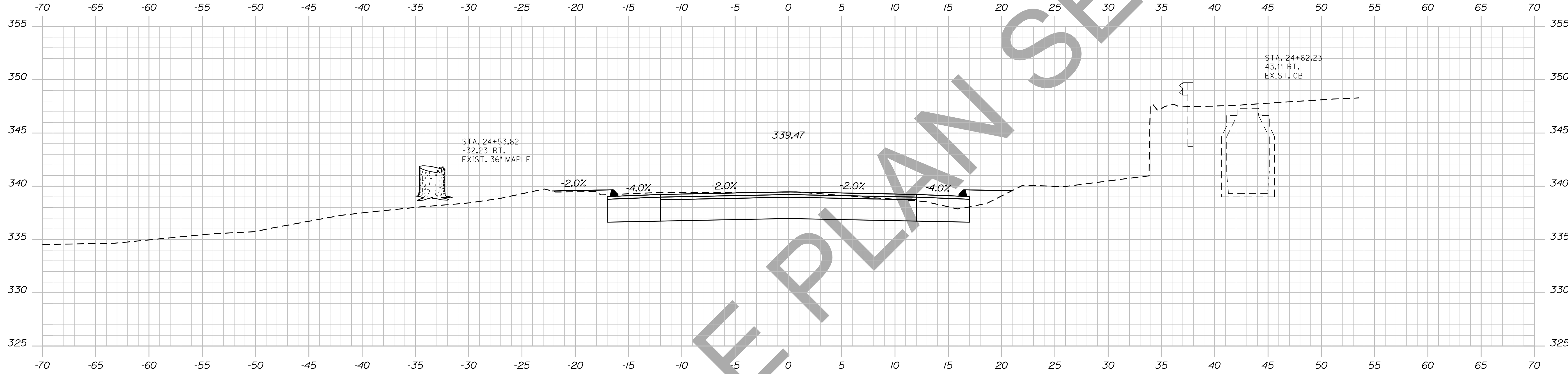

SAMPLE PLAN SET

STATE OF MAINE
DEPARTMENT OF TRANSPORTATION
018246-00

SIGNATURE
P.E. NUMBER
DATE

PROJ. MANAGER	DESIGN DET. TAILED	CHECKED-REVISED	BY	DATE

DEXTER
ROUTE 7
CROSS SECTIONS

SHEET NUMBER
37
OF 15

Date: 12/10/2013

Username: atlee.mousseau

Division: HIGHWAY

Filename: ... \038_Xsect_25+00_014.dgn

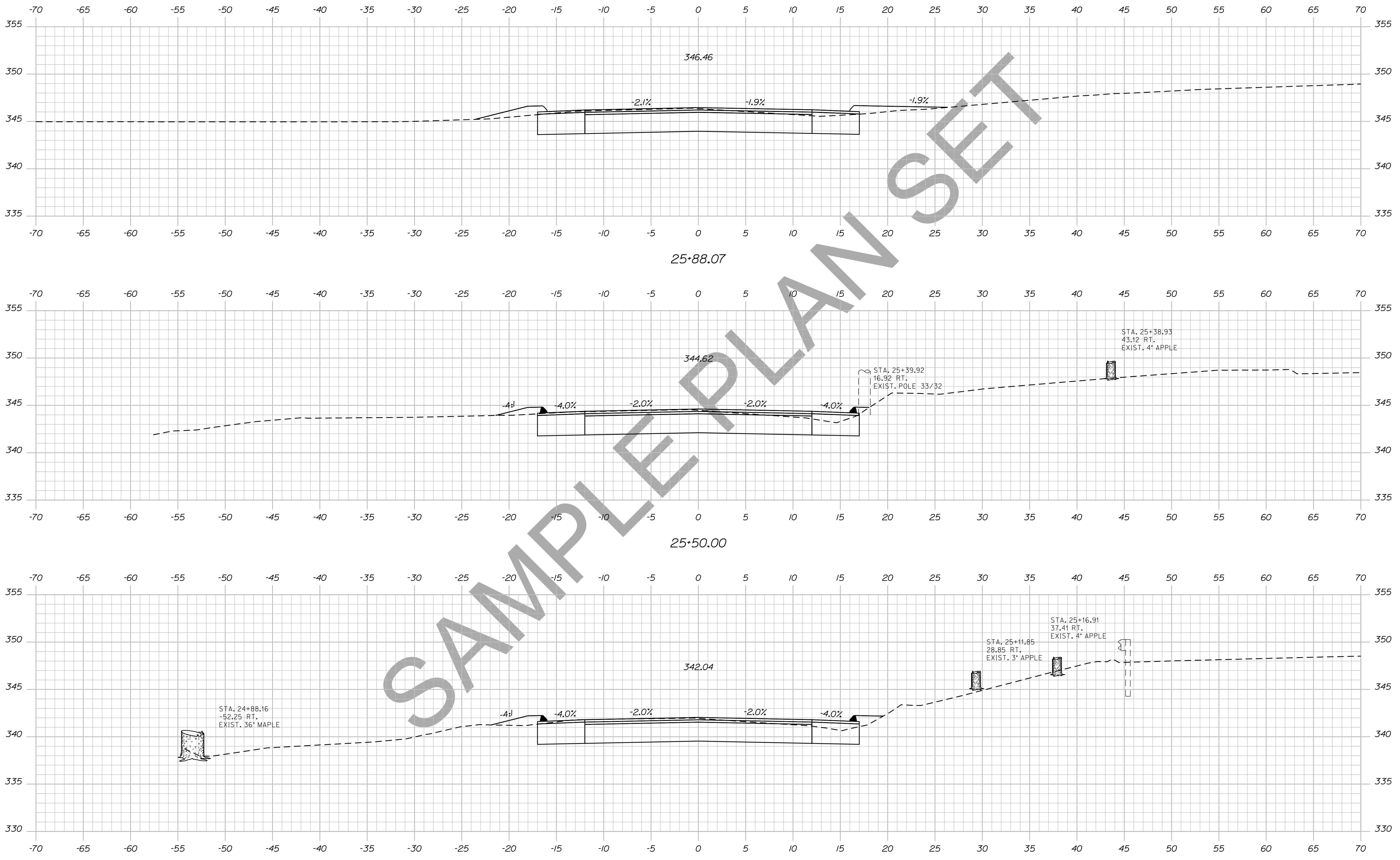

STATE OF MAINE
DEPARTMENT OF TRANSPORTATION
018246.00
WIN
PIN 18246.00
HIGHWAY PLANS

PROJ. MANAGER	BY	DATE	SIGNATURE
DESIGN-DETAILED	DESIGNER	DATE	SIGNATURE
CHECKED-REVIEWED	CHECKER	DATE	SIGNATURE
DESIGN-DETAILED	DESIGNER	DATE	SIGNATURE
DESIGN-DETAILED	DESIGNER	DATE	SIGNATURE
REVISIONS 1	REVISOR	DATE	P.E. NUMBER
REVISIONS 2	REVISOR	DATE	P.E. NUMBER
REVISIONS 3	REVISOR	DATE	P.E. NUMBER
REVISIONS 4	REVISOR	DATE	P.E. NUMBER
FIELD CHANGES	FIELD CHANGER	DATE	P.E. NUMBER

DEXTER
ROUTE 7
CROSS SECTIONS

SHEET NUMBER
38
OF 15

Date: 12/10/2013

Username: atlee.mousseau

Division: HIGHWAY

Filename: ... \039_xsect_26-00_015.dgn

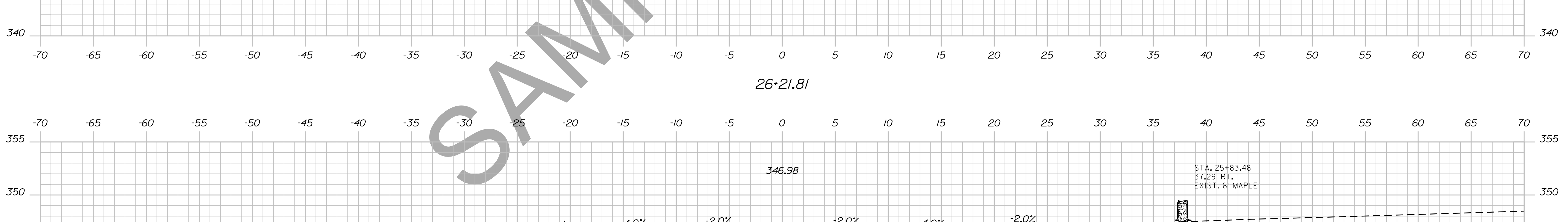
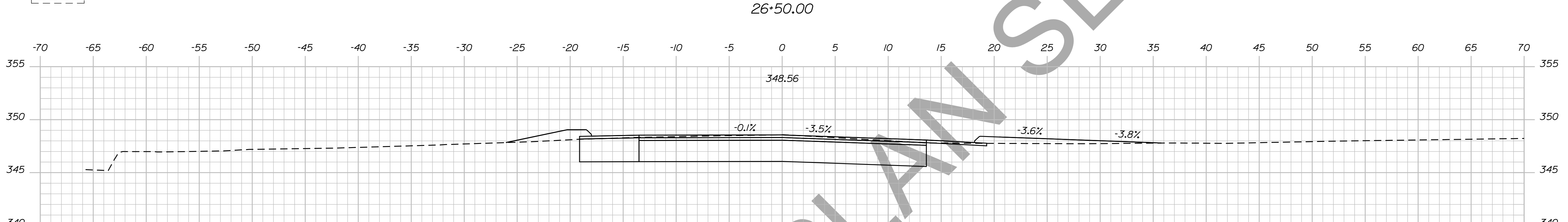
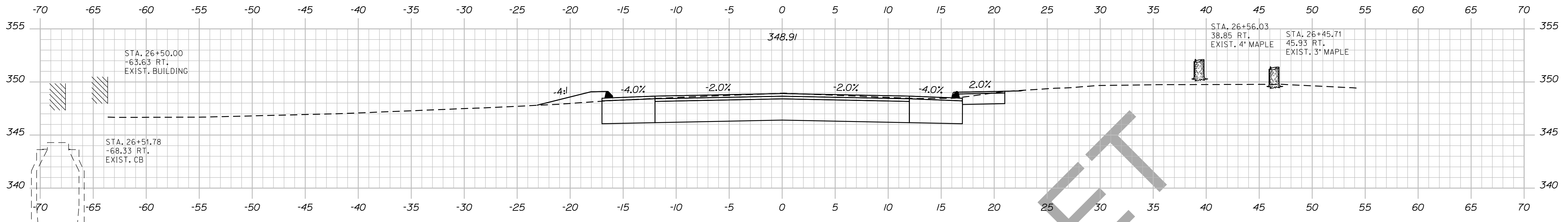

STATE OF MAINE
DEPARTMENT OF TRANSPORTATION
018246.00
WIN
PIN 18246.00
HIGHWAY PLANS

SIGNATURE
P.E. NUMBER
DATE

PROJ. MANAGER	DESIGNER	CHECKER	DATE

DEXTER
ROUTE 7
CROSS SECTIONS

SHEET NUMBER
39
OF 15

Date: 12/10/2013

Username: atlee.mousseau

Division: HIGHWAY

Filename: ... \040_xsect_27+00_016.dgn

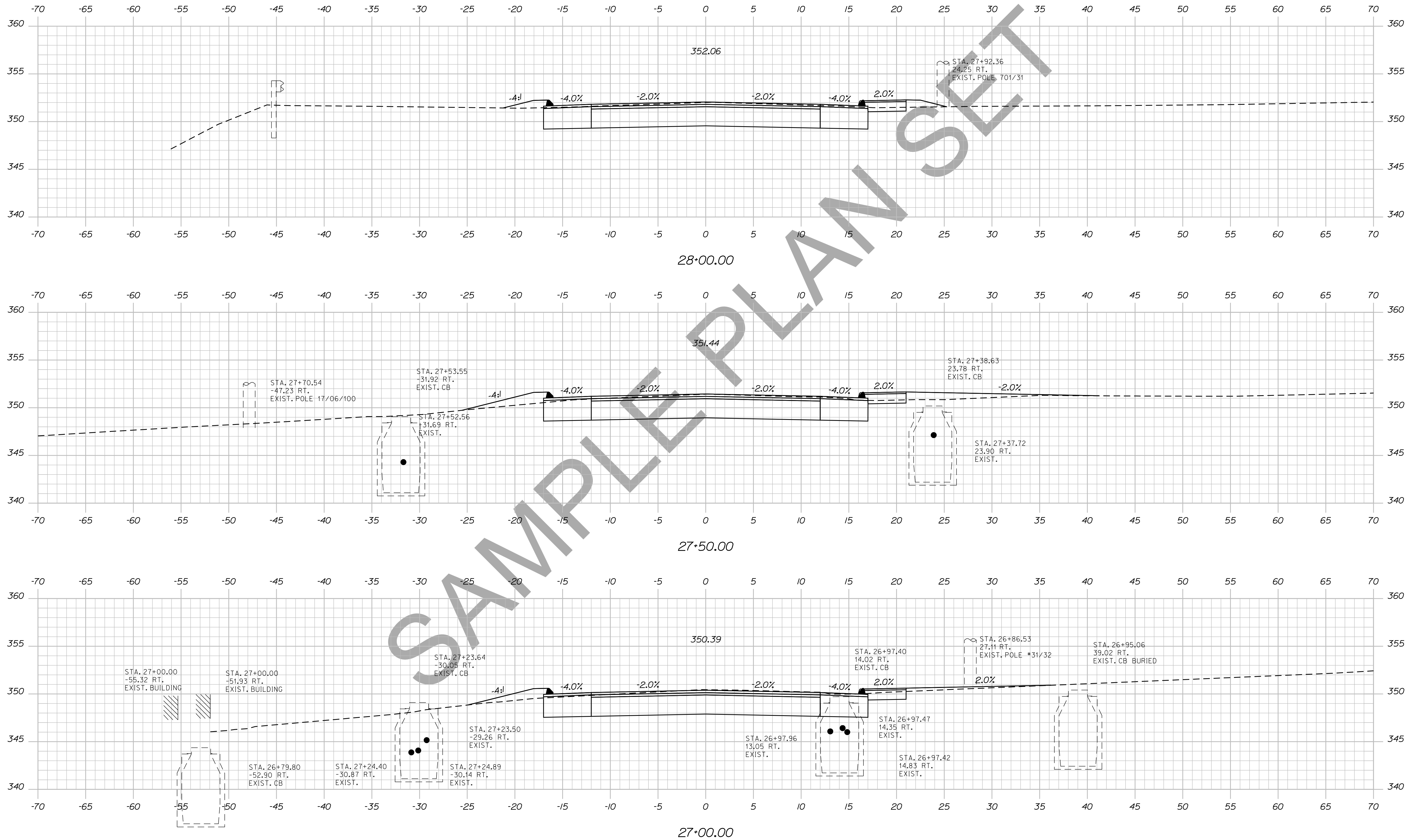

STATE OF MAINE
DEPARTMENT OF TRANSPORTATION
018246.00
WIN
PIN 18246.00
HIGHWAY PLANS

PROJ. MANAGER	BY	DATE
DESIGN-DETAILED	DESIGNER	DATE
CHECKED-REVIEWED	CHECKER	DATE
DESIGN-DETAILED	DESIGNER	DATE
DESIGN-DETAILED	DESIGNER	DATE
REVISIONS 1	REVISION	DATE
REVISIONS 2	REVISION	DATE
REVISIONS 3	REVISION	DATE
REVISIONS 4	REVISION	DATE
FIELD CHANGES	FIELD	DATE

DEXTER
ROUTE 7
CROSS SECTIONS

SHEET NUMBER
40
OF 15

Date: 12/10/2013

Username: atlee.mousseau

Division: HIGHWAY

Filename: ... \042_xsect_28-50_01B.dgn

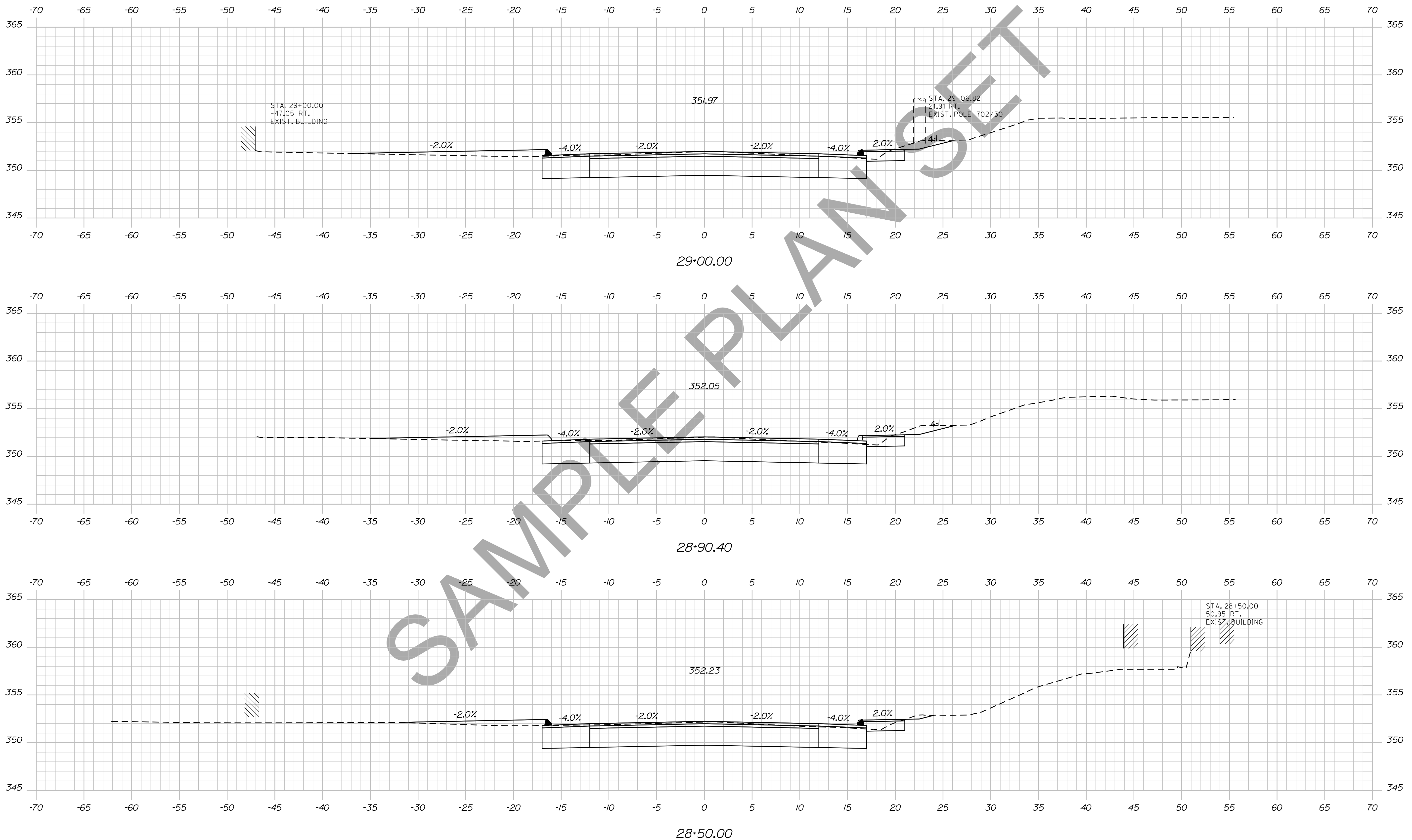

STATE OF MAINE
DEPARTMENT OF TRANSPORTATION
018246.00
WIN
PIN 18246.00
HIGHWAY PLANS

PROJ. MANAGER	BY	DATE	SIGNATURE
DESIGN DETAILED	DESIGNER	DATE	
CHECKED/REVIEWED	CHECKER	DATE	
DESIGNS DETAILED	DESIGNER	DATE	
DESIGNS DETAILED	DESIGNER	DATE	
REVISIONS 1	---	---	---
REVISIONS 2	---	---	---
REVISIONS 3	---	---	---
REVISIONS 4	---	---	---
FIELD CHANGES	---	---	---

DEXTER
ROUTE 7
CROSS SECTIONS

SHEET NUMBER
42
OF 15

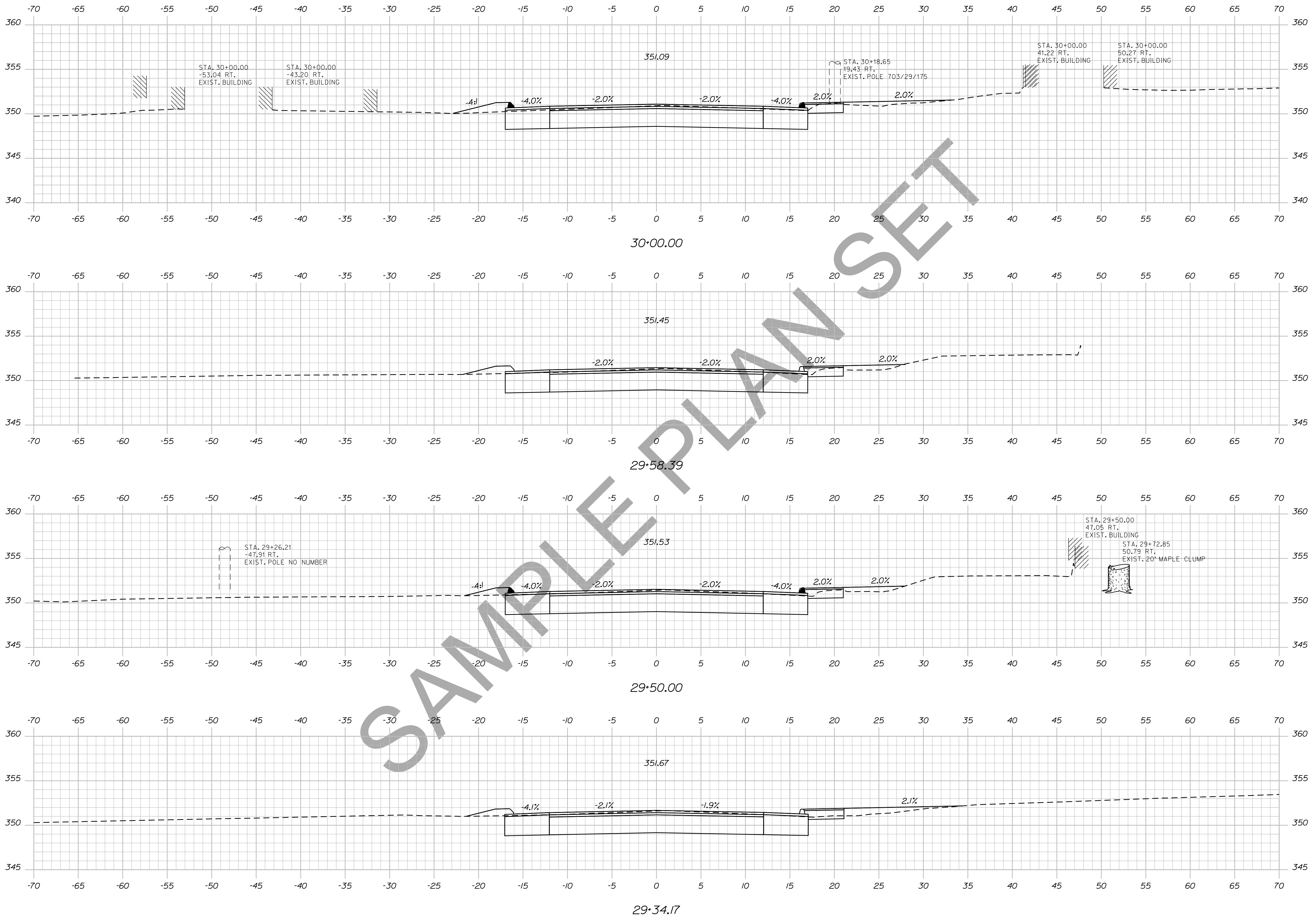

STATE OF MAINE
DEPARTMENT OF TRANSPORTATION
018246.00
WIN
PIN 18246.00
HIGHWAY PLANS

PROJ. MANAGER	DESIGN-DETAILED	CHECKED-REVIEWED	DESIGN-DETAILED	DESIGN-DETAILED	REVISIONS 1	REVISIONS 2	REVISIONS 3	REVISIONS 4	FIELD CHANGES	BY	DATE	SIGNATURE	P.E. NUMBER	DATE

DEXTER
ROUTE 7
CROSS SECTIONS

SHEET NUMBER
43
OF 15

Date: 12/10/2013

Username: atlee.mousseau

Division: HIGHWAY

Filename: ... \044_xsect_30+50_020.dgn

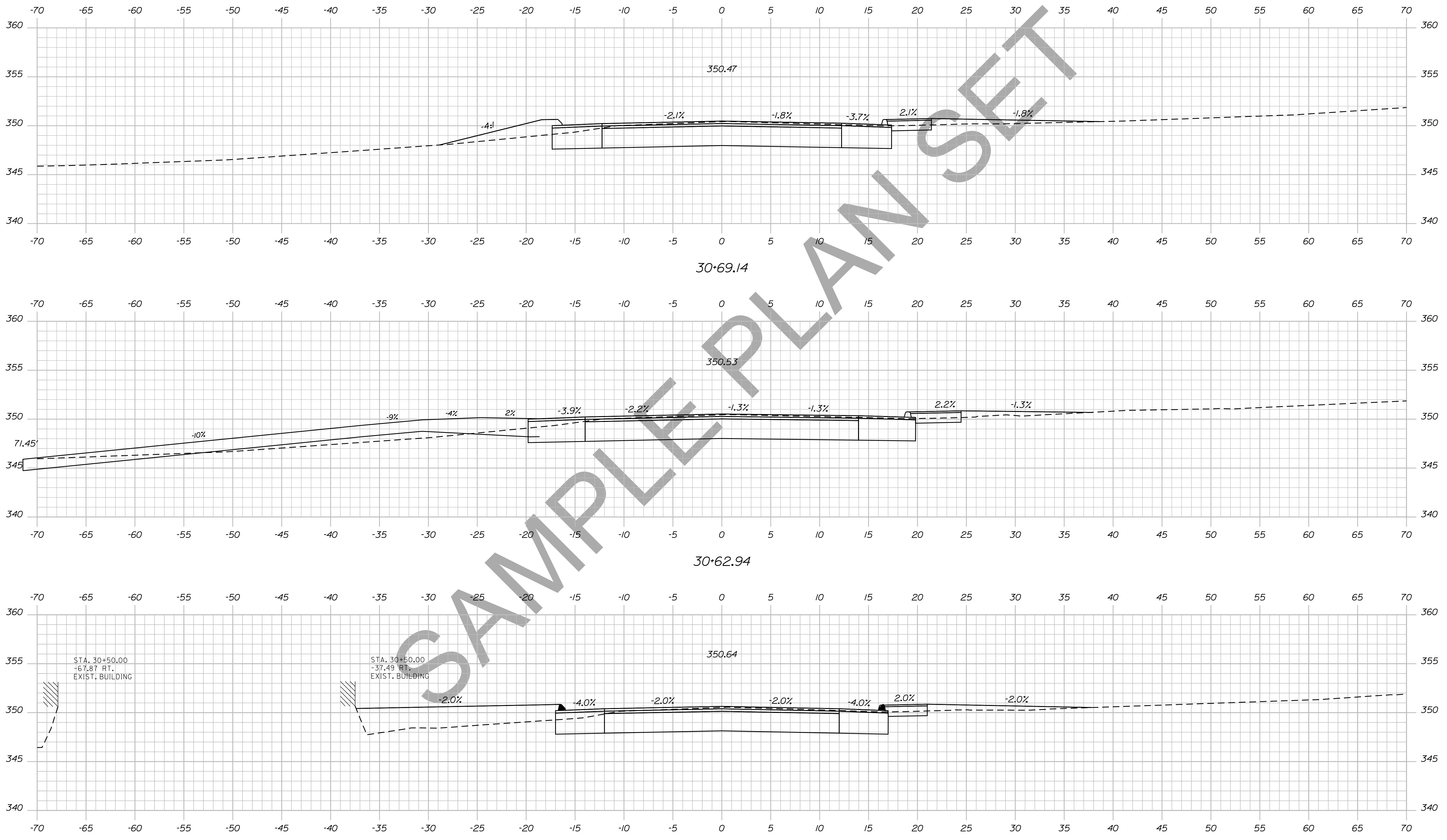

STATE OF MAINE
DEPARTMENT OF TRANSPORTATION
018246.00
WIN
PIN 18246.00
HIGHWAY PLANS

PROJ. MANAGER	BY	DATE
DESIGN-DETAILED	DESIGNER	DATE
CHECKED-REVIEWED	CHECKER	DATE
DESIGN DET AILED	DESIGNER	DATE
DESIGN DET AILED	DESIGNER	DATE
REVISIONS 1	DESIGNER	DATE
REVISIONS 2	DESIGNER	DATE
REVISIONS 3	DESIGNER	DATE
REVISIONS 4	DESIGNER	DATE
FIELD CHANGES	DESIGNER	DATE

DEXTER
ROUTE 7
CROSS SECTIONS

SHEET NUMBER
44
OF 15

Date: 12/10/2013

Username: atlee.mousseau

Division: HIGHWAY

Filename: ... \045_xsect_31+00_021.dgn

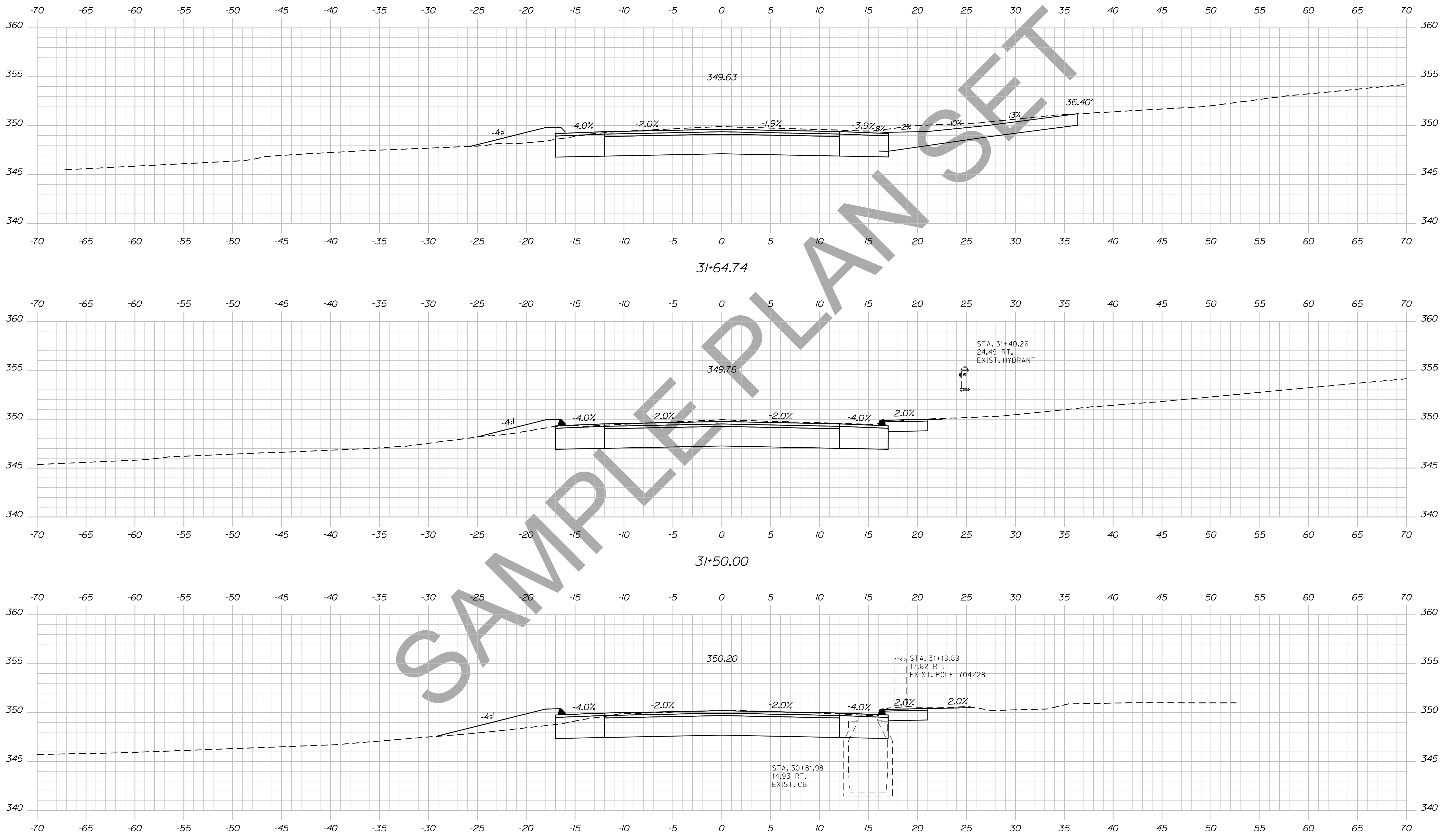

STATE OF MAINE
DEPARTMENT OF TRANSPORTATION
018246.00
WIN
PIN 18246.00
HIGHWAY PLANS

PROJ. MANAGER	BY	DATE
DESIGN DETAILED	DESIGNER	DATE
CHECKED/REVIEWED	BY	DATE
DESIGN DETAILED	DESIGNER	DATE
DESIGN DETAILED	DESIGNER	DATE
REVISIONS 1	BY	DATE
REVISIONS 2	BY	DATE
REVISIONS 3	BY	DATE
REVISIONS 4	BY	DATE
FIELD CHANGES	BY	DATE

DEXTER
ROUTE 7
CROSS SECTIONS

SHEET NUMBER
45
OF 15

Username: atlee.mousseau Date:12/10/2013

Division: HIGHWAY

Filename: ... \048_xsect_33+40_024.dgn

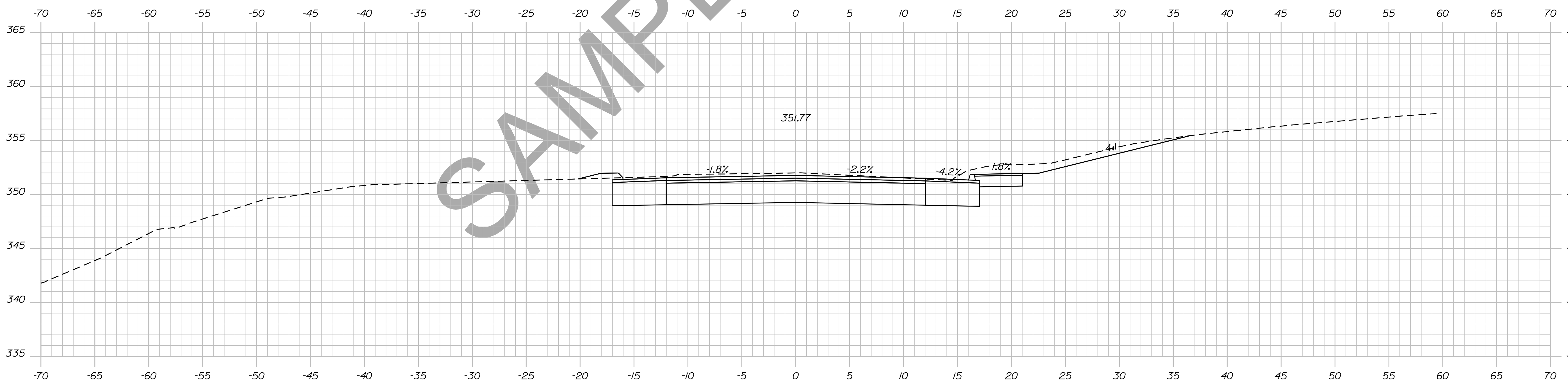
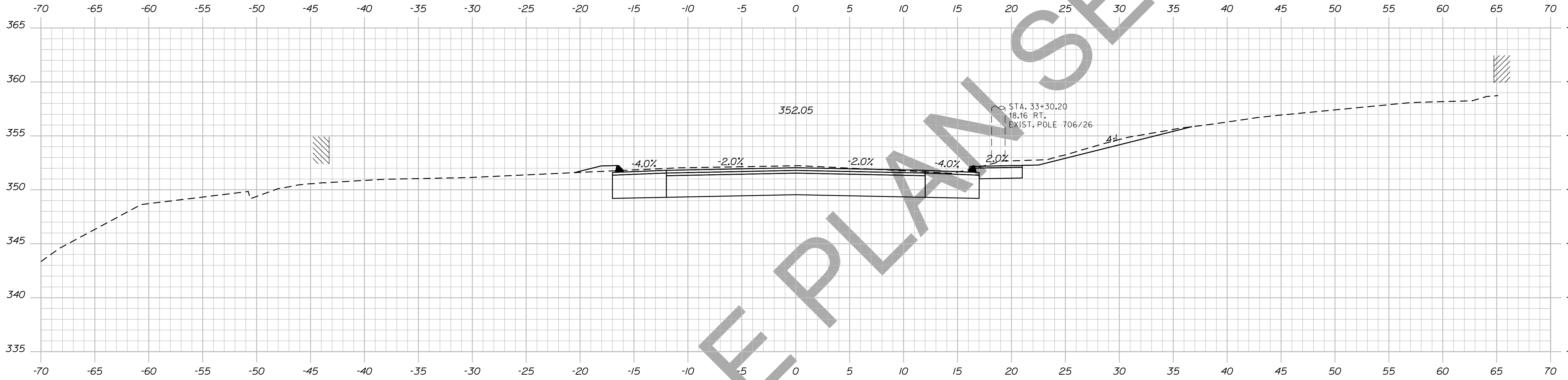

STATE OF MAINE
DEPARTMENT OF TRANSPORTATION
018246.00
WIN
PIN 18246.00
HIGHWAY PLANS

PROJ. MANAGER	BY	DATE	SIGNATURE
DESIGN-DETAILED	DESIGNER	DATE	
CHECKED-REVIEWED	CHECKER	DATE	
DESIGN-Detailed	DESIGNER	DATE	
DESIGN-Detailed	DESIGNER	DATE	
REVISIONS 1	DESIGNER	DATE	
REVISIONS 2	DESIGNER	DATE	
REVISIONS 3	DESIGNER	DATE	
REVISIONS 4	DESIGNER	DATE	
FIELD CHANGES	FIELD	DATE	

DEXTER
ROUTE 7
CROSS SECTIONS

SHEET NUMBER
48
OF 15

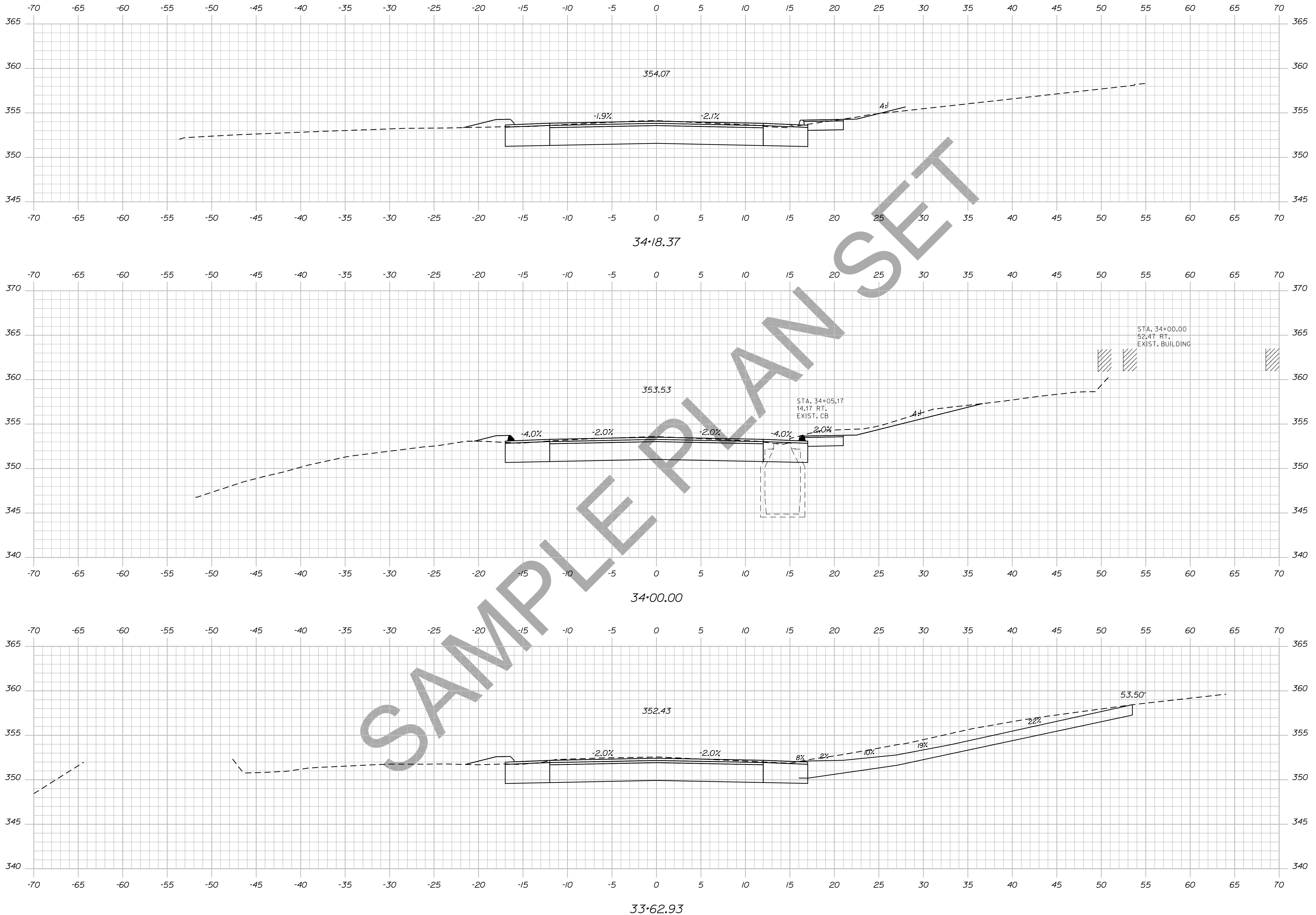

STATE OF MAINE
DEPARTMENT OF TRANSPORTATION
018246.00
WIN
PIN 18246.00
HIGHWAY PLANS

PROJ. MANAGER	BY	DATE	SIGNATURE
DESIGN-DETAILED	DESIGNER	DATE	SIGNATURE
CHECKED-REVIEWED	CHECKER	DATE	SIGNATURE
DESIGN-DETAILED	DESIGNER	DATE	SIGNATURE
DESIGN-DETAILED	DESIGNER	DATE	SIGNATURE
REVISIONS 1	REVISION	DATE	P.E. NUMBER
REVISIONS 2	REVISION	DATE	DATE
REVISIONS 3	REVISION	DATE	
REVISIONS 4	REVISION	DATE	
FIELD CHANGES	FIELD	DATE	

DEXTER
ROUTE 7
CROSS SECTIONS

SHEET NUMBER
49
OF 15

Date: 12/10/2013

Username: atlee.mousseau

Division: HIGHWAY

Filename: ... \050_xsect_34+21_026.dgn

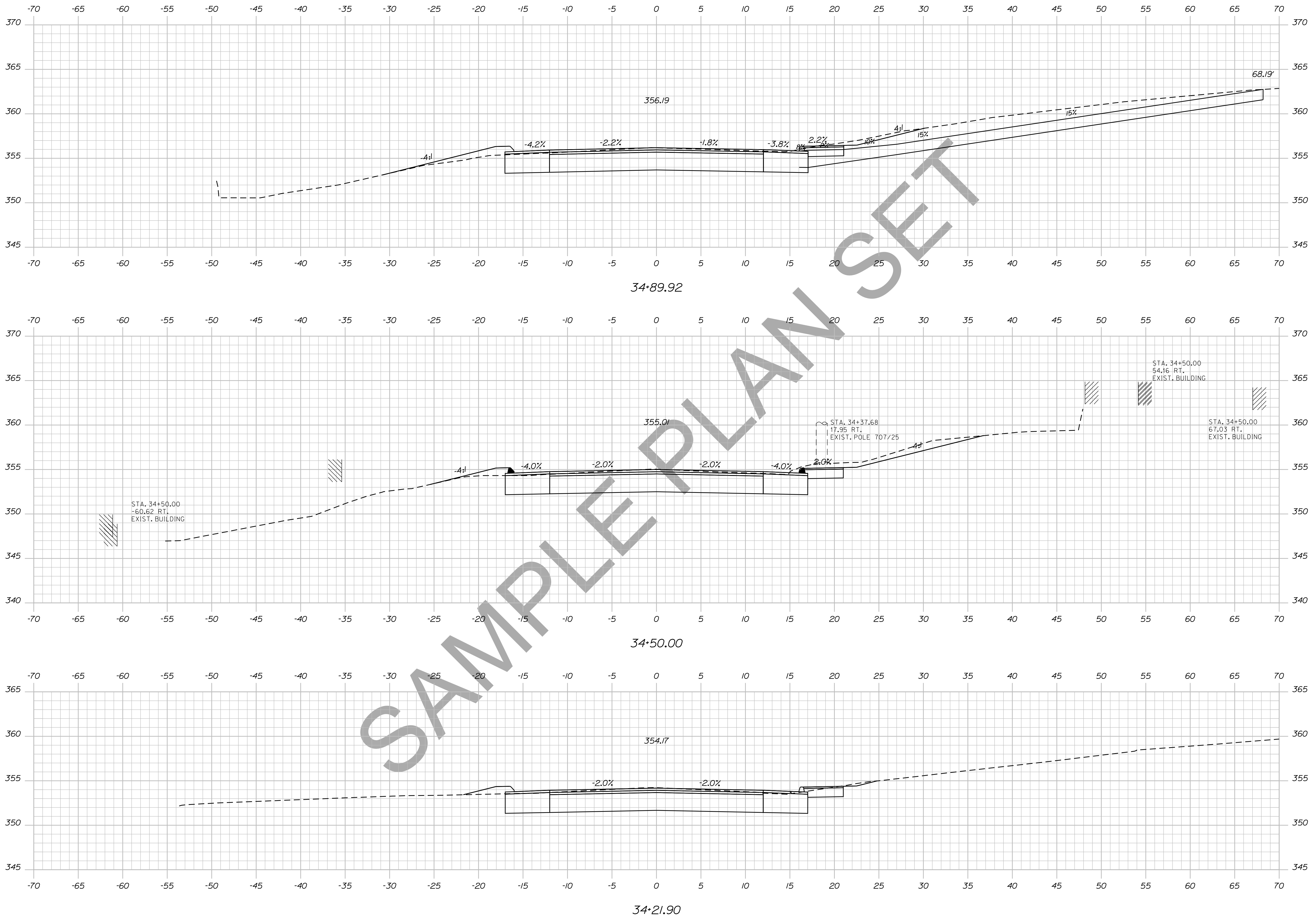

STATE OF MAINE
DEPARTMENT OF TRANSPORTATION
018246.00
WIN
PIN 18246.00
HIGHWAY PLANS

PROJ. MANAGER	BY	DATE	SIGNATURE
DESIGN DETAILED	DESIGNER 1	PROJ. DATE 1	PROJ. DATE 1
CHECKED-REVIEWED	DESIGNER 2	PROJ. DATE 2	PROJ. DATE 2
DESIGNS DET. TAILED	DESIGNER 3	PROJ. DATE 3	PROJ. DATE 3
DESIGNS DET. TAILED	DESIGNER 4	PROJ. DATE 4	PROJ. DATE 4
REVISIONS 1	REVISION 1	REVISION DATE 1	REVISION DATE 1
REVISIONS 2	REVISION 2	REVISION DATE 2	REVISION DATE 2
REVISIONS 3	REVISION 3	REVISION DATE 3	REVISION DATE 3
REVISIONS 4	REVISION 4	REVISION DATE 4	REVISION DATE 4
FIELD CHANGES	FIELD CHANGES	FIELD CHANGES	FIELD CHANGES

DEXTER
ROUTE 7
CROSS SECTIONS

SHEET NUMBER
50
OF 15

Date: 12/10/2013

Username: atlee.mousseau

Division: HIGHWAY

Filename: ... \051_Xsect_35+00_027.dgn

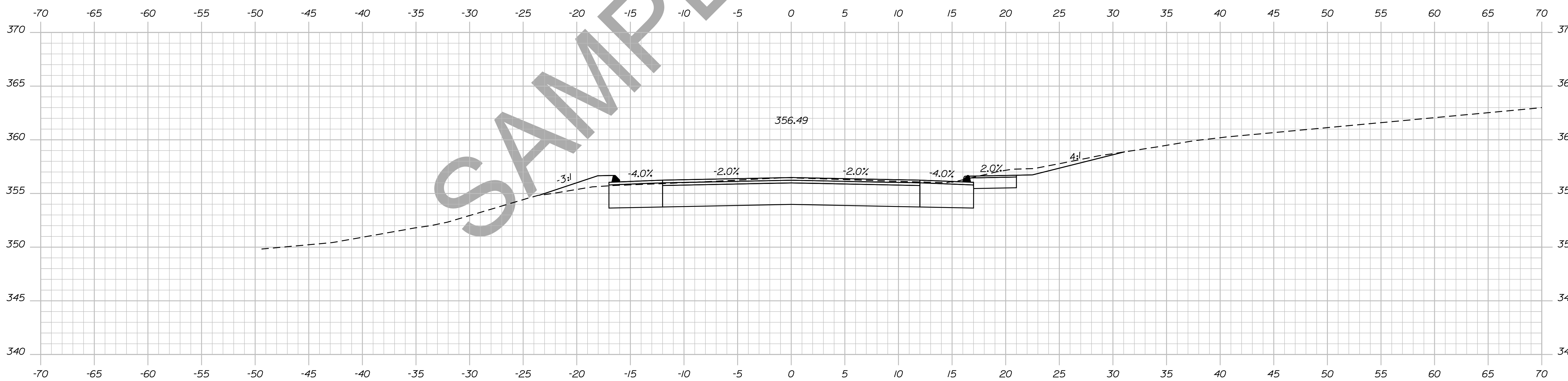
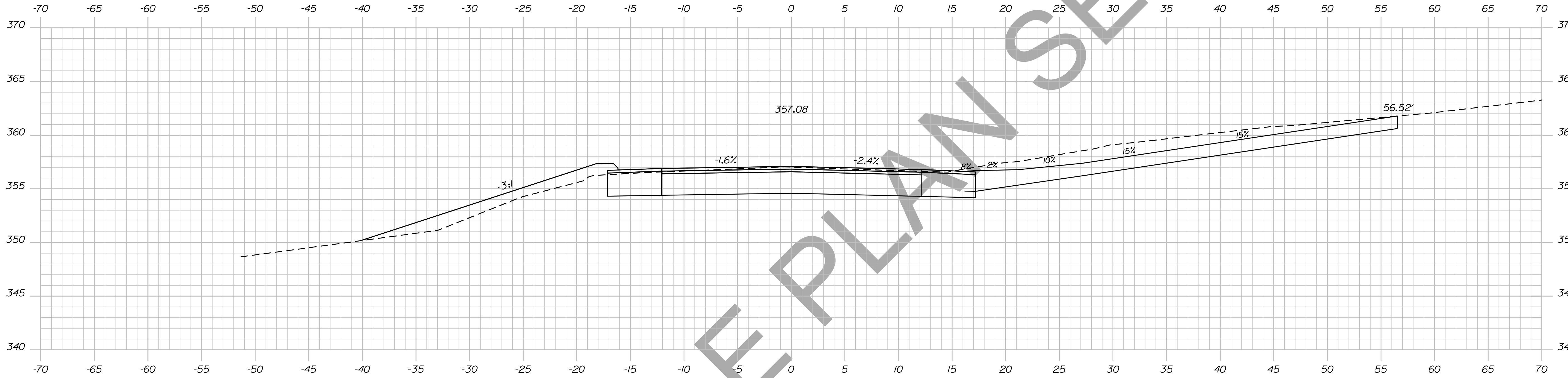

35+00.00

STATE OF MAINE
DEPARTMENT OF TRANSPORTATION
018246.00
WIN
PIN 18246.00
HIGHWAY PLANS

SIGNATURE
P.E. NUMBER
DATE

PROJ. MANAGER	DESIGN-DETAILED	CHECKED-REVIEWED	DESIGN-DETAILED	DESIGN-DETAILED	REVISIONS 1	REVISIONS 2	REVISIONS 3	REVISIONS 4	FIELD CHANGES

DEXTER
ROUTE 7
CROSS SECTIONS

SHEET NUMBER
51
OF 15

Sta. 35+00.00 to Sta. 35+20.26

Username: atlee.mousseau Date:12/10/2013

Division: HIGHWAY

Filename: ... \052_xsect_35+50_028.dgn

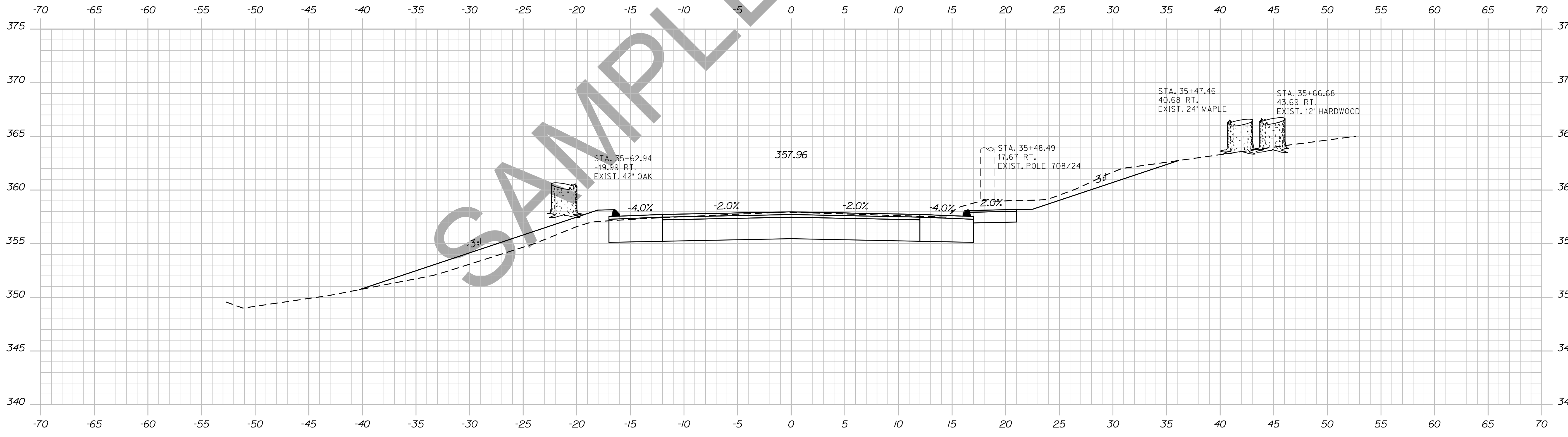
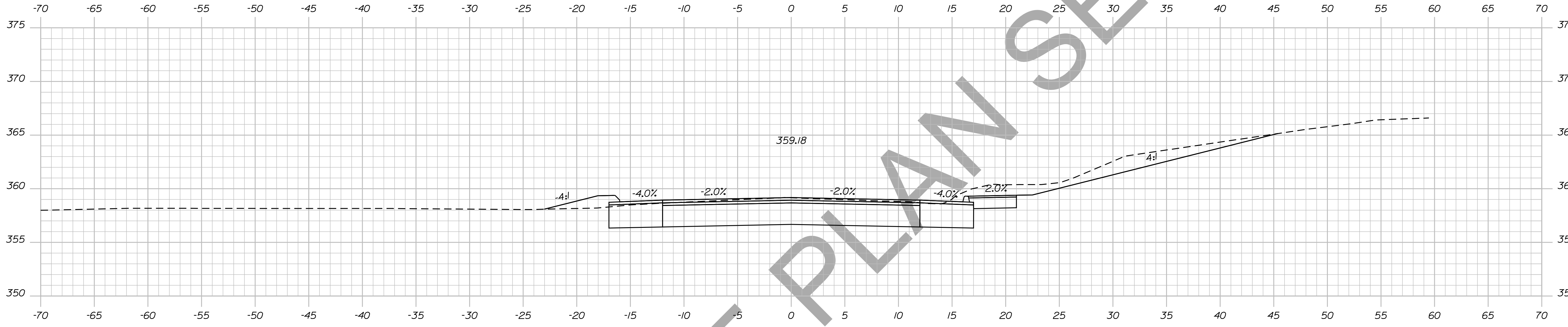

STATE OF MAINE
DEPARTMENT OF TRANSPORTATION
018246.00
WIN
PIN 18246.00
HIGHWAY PLANS

PROJ. MANAGER	BY	DATE	SIGNATURE
DESIGN DETAILER	DESIGNER	DATE	SIGNATURE
CHECKED/REVIEWED	DESIGNER	DATE	P.E. NUMBER
DESIGNS DET AILED	DESIGNER	DATE	DATE
DESIGNS DET AILED	DESIGNER	DATE	DATE
REVISIONS 1	DESIGNER	DATE	DATE
REVISIONS 2	DESIGNER	DATE	DATE
REVISIONS 3	DESIGNER	DATE	DATE
REVISIONS 4	DESIGNER	DATE	DATE
FIELD CHANGES	DESIGNER	DATE	DATE

DEXTER
ROUTE 7
CROSS SECTIONS

SHEET NUMBER
52
OF 15

Date: 12/10/2013

Username: atlee.mousseau

Division: HIGHWAY

Filename: ... \0533_Xsect_36-00_029.dgn

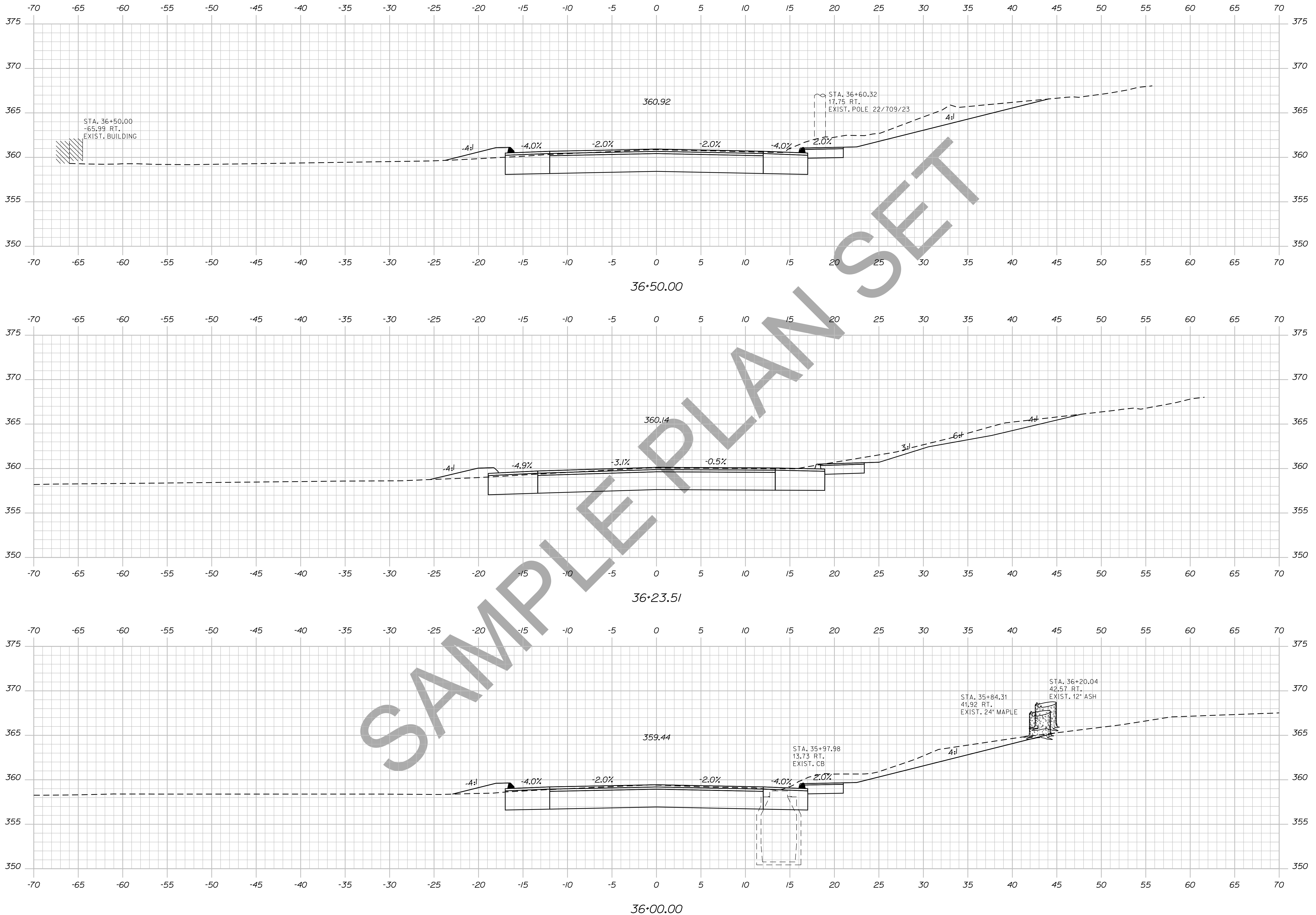

STATE OF MAINE DEPARTMENT OF TRANSPORTATION		018246.00	
SIGNATURE		P.E. NUMBER	
DATE		DATE	
PROJ. MANAGER	DESIGNER	BY	DATE
CHECKED-REVIEWED	DESIGNED-DRAWN	DESIGNED-DRAWN	DESIGNED-DRAWN
DESIGNED-DRAWN	DESIGNED-DRAWN	DESIGNED-DRAWN	DESIGNED-DRAWN
REVISIONS 1	REVISIONS 2	REVISIONS 3	REVISIONS 4
REVISIONS 1	REVISIONS 2	REVISIONS 3	REVISIONS 4
REVISIONS 1	REVISIONS 2	REVISIONS 3	REVISIONS 4
REVISIONS 1	REVISIONS 2	REVISIONS 3	REVISIONS 4
FIELD CHANGES	FIELD CHANGES	FIELD CHANGES	FIELD CHANGES
DEXTER ROUTE 7		CROSS SECTIONS	
SHEET NUMBER		53	
		OF 15	

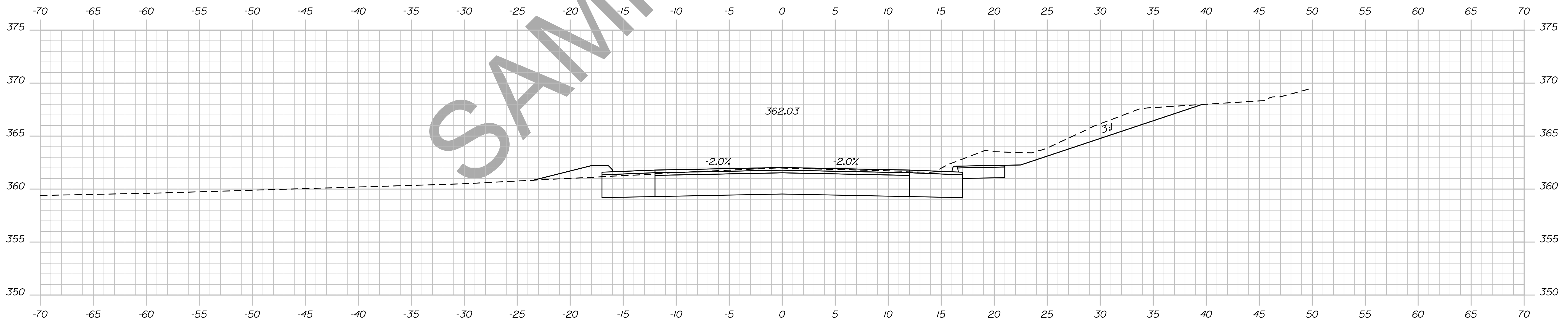
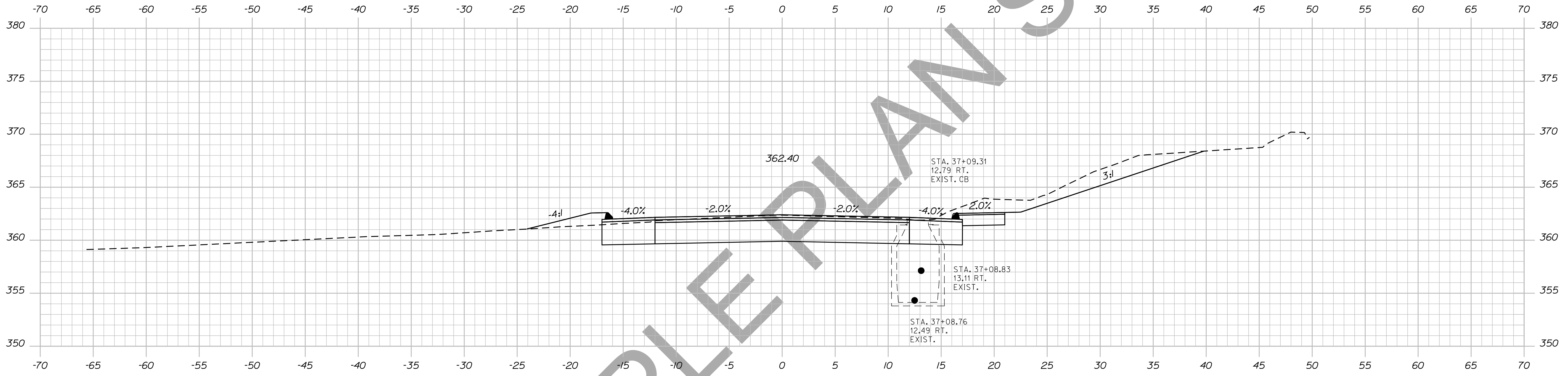

SAMPLE PLAN SET

STATE OF MAINE
DEPARTMENT OF TRANSPORTATION
018246.00
WIN
PIN 18246.00
HIGHWAY PLANS

PROJ. MANAGER	BY	DATE	SIGNATURE
DESIGN-DETAILED	DESIGNER	DATE	
CHECKED-REVIEWED	CHECKER	DATE	
DESIGN-DETAILED	DESIGNER	DATE	
DESIGN-DETAILED	DESIGNER	DATE	
REVISIONS 1	REVISION	DATE	
REVISIONS 2	REVISION	DATE	
REVISIONS 3	REVISION	DATE	
REVISIONS 4	REVISION	DATE	
FIELD CHANGES	FIELD	DATE	

DEXTER
ROUTE 7
CROSS SECTIONS

SHEET NUMBER
54
OF 15

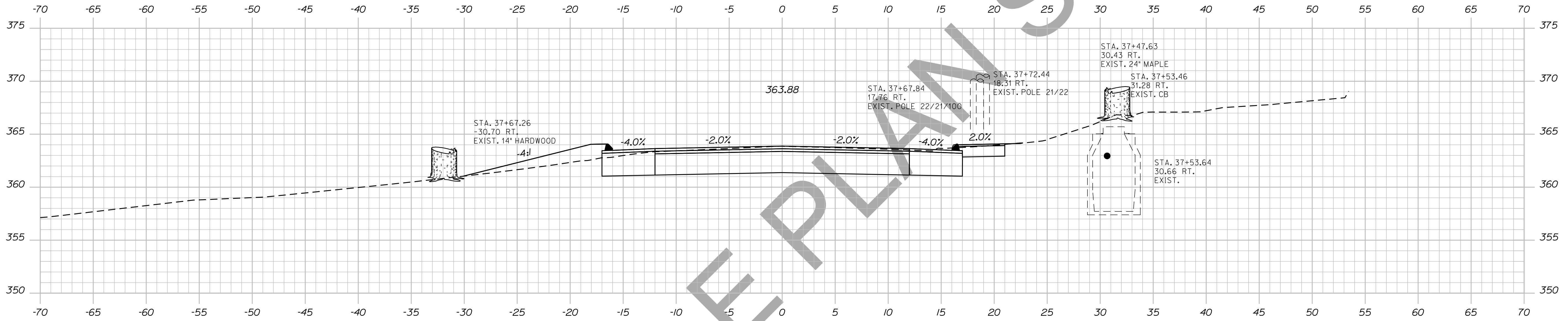

SAMPLE PLAN SET

STATE OF MAINE
DEPARTMENT OF TRANSPORTATION

018246.00

WIN
PIN 18246.00

HIGHWAY PLANS

SIGNATURE

P.E. NUMBER

DATE

DATE

BY

PROJ. MANAGER

CHECKED-REVIEWED

DESIGN DETAILED

DESIGN DETAILED

DESIGN DETAILED

REVISIONS 1

REVISIONS 2

REVISIONS 3

REVISIONS 4

FIELD CHANGES

FIELD CHANGES

FIELD CHANGES

FIELD CHANGES

FIELD CHANGES

FIELD CHANGES

DEXTER
ROUTE 7
CROSS SECTIONS

SHEET NUMBER

55

OF 15

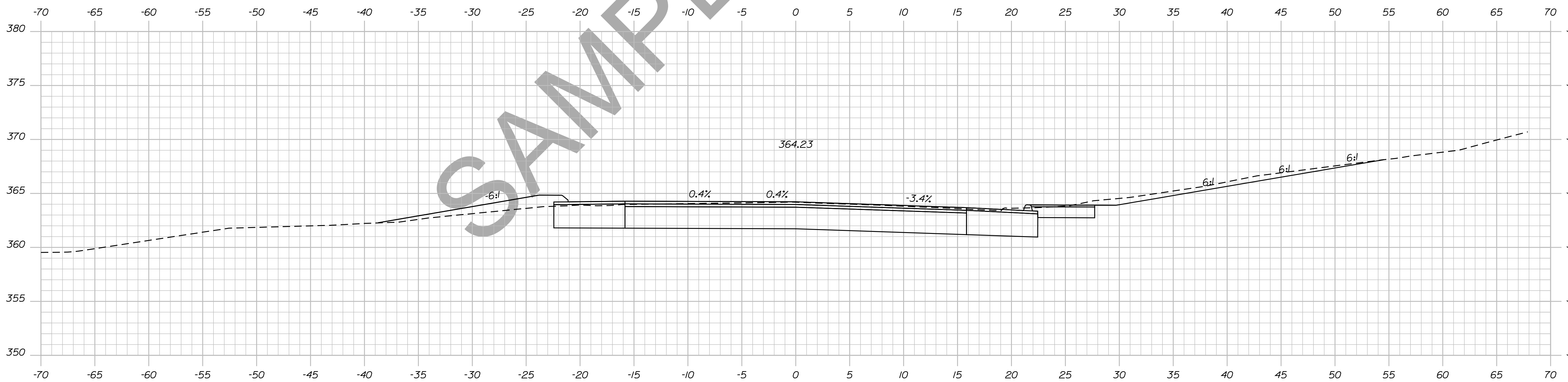
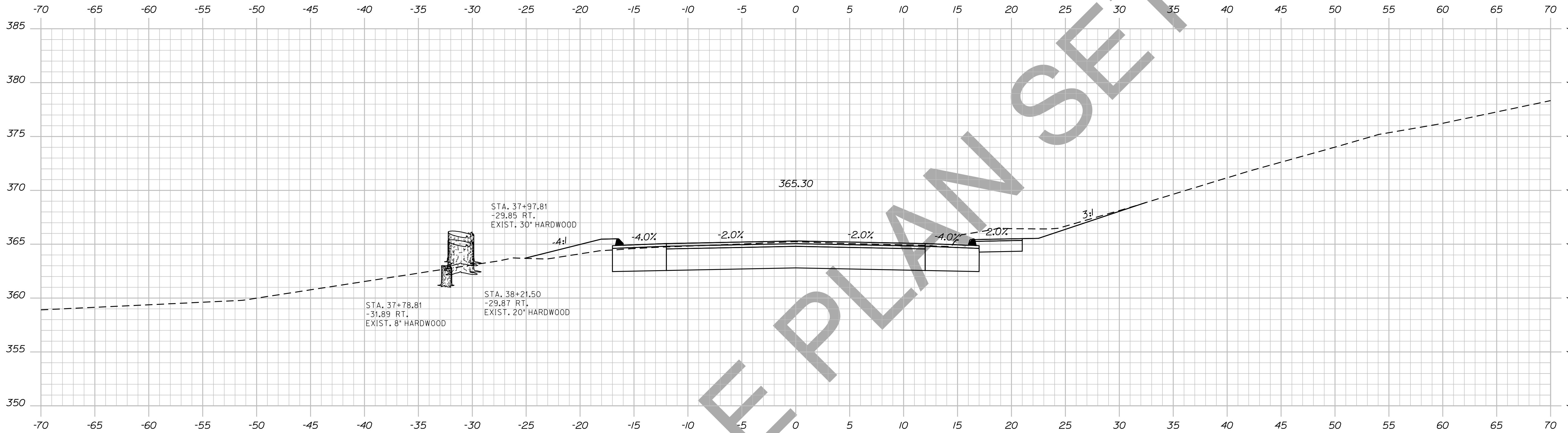

PROJ. MANAGER	DESIGN-DETAILED	CHECKED-REVIEWED	DESIGN-DETAILED	DESIGN-DETAILED	REVISIONS 1	REVISIONS 2	REVISIONS 3	REVISIONS 4	FIELD CHANGES

BY	DATE	SIGNATURE

P.E. NUMBER	DATE

DEXTER
ROUTE 7
CROSS SECTIONS

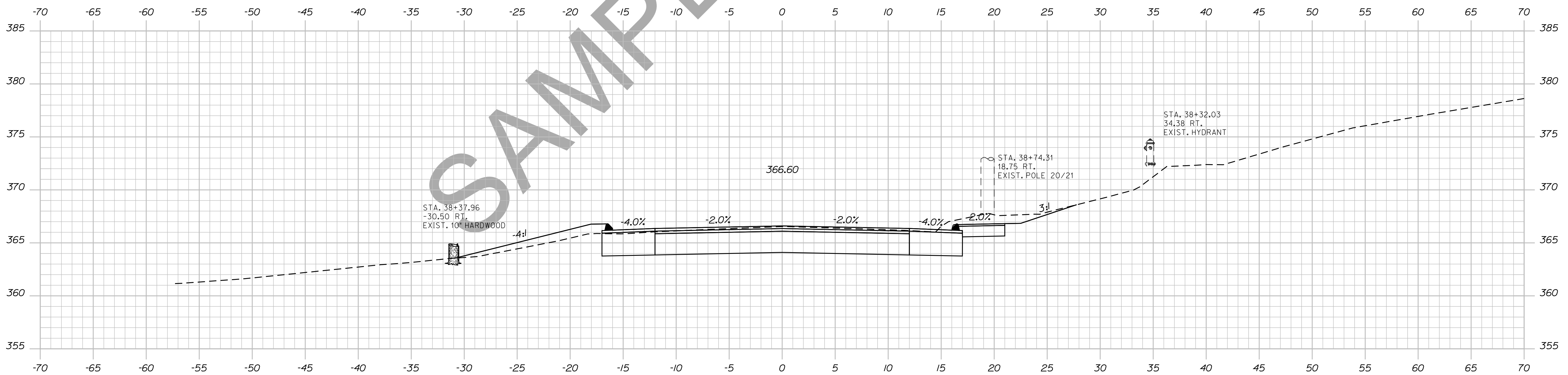
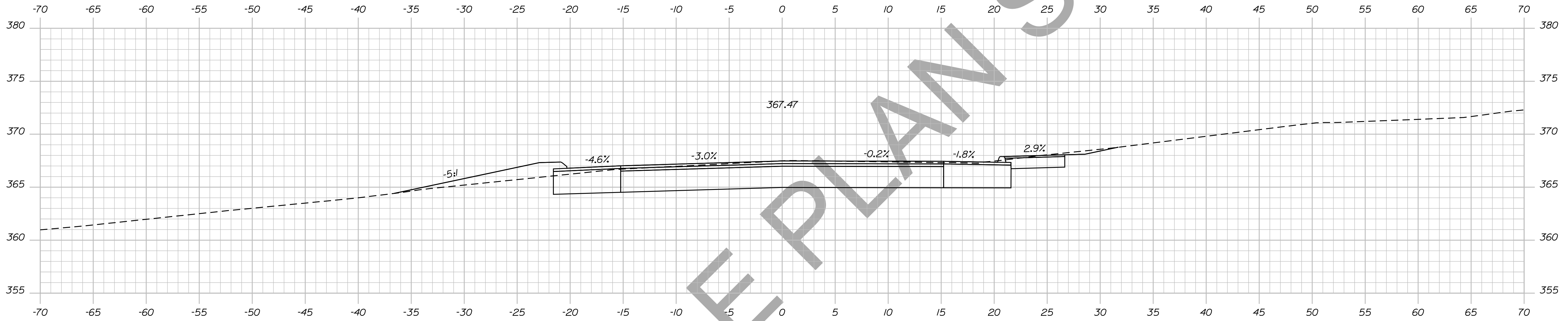

SAMPLE PLAN SET

STATE OF MAINE
DEPARTMENT OF TRANSPORTATION
018246.00
WIN
PIN 18246.00
HIGHWAY PLANS

PROJ. MANAGER	BY	DATE	SIGNATURE
DESIGN DETAILED	DESIGNER	DATE	
CHECKED-REVIEWED	CHECKER	DATE	
DESIGN DETAILED	DESIGNER	DATE	
DESIGN DETAILED	DESIGNER	DATE	
REVISIONS 1	REVISION	DATE	
REVISIONS 2	REVISION	DATE	
REVISIONS 3	REVISION	DATE	
REVISIONS 4	REVISION	DATE	
FIELD CHANGES	FIELD	DATE	

DEXTER
ROUTE 7
CROSS SECTIONS

SHEET NUMBER
57
OF 15

Date: 12/10/2013

Username: atlee.mousseau

Division: HIGHWAY

Filename: ... \058_Xsect_39-00_034.dgn

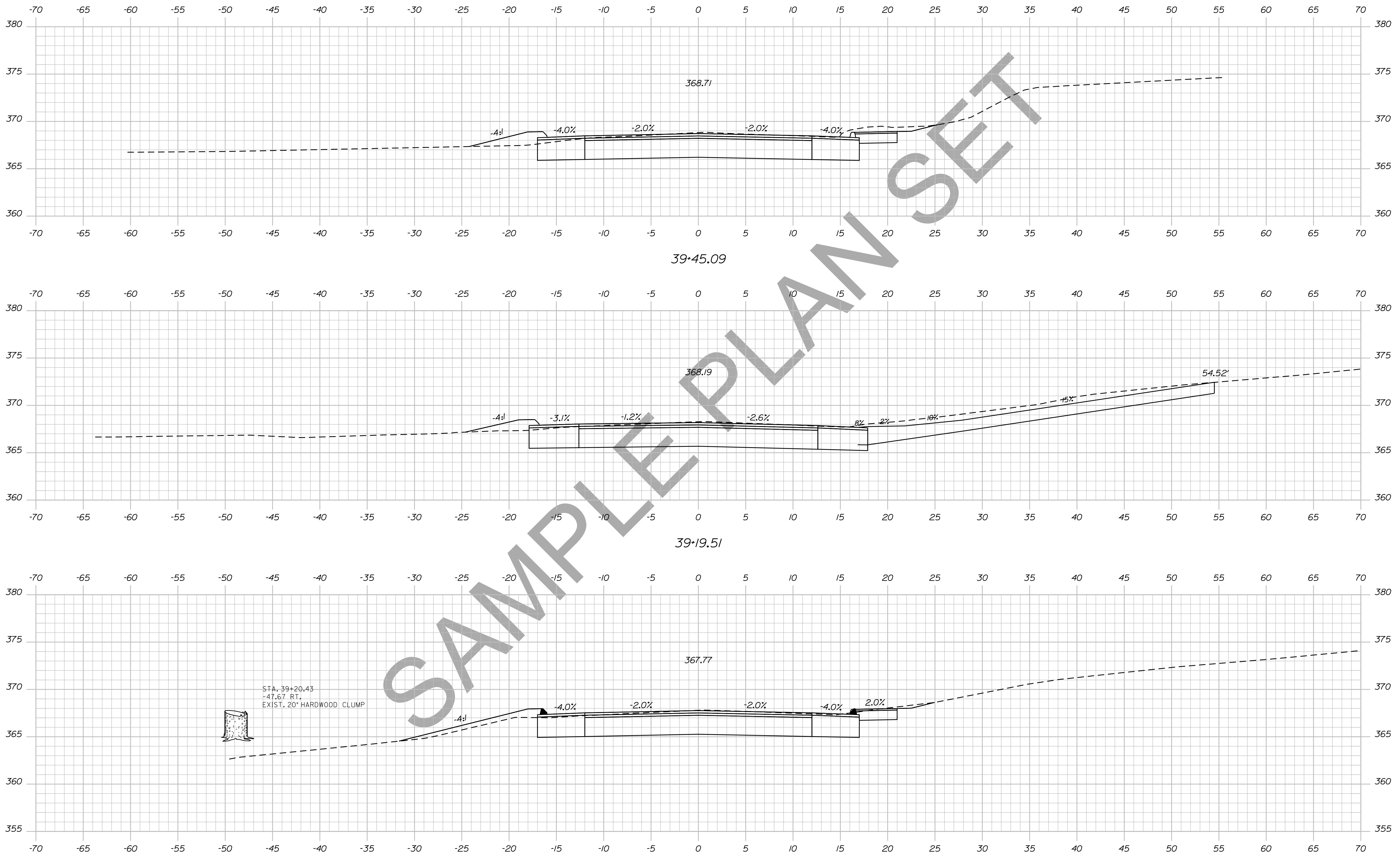

STATE OF MAINE
DEPARTMENT OF TRANSPORTATION
018246.00
WIN
PIN 18246.00
HIGHWAY PLANS

PROJ. MANAGER	BY	DATE	SIGNATURE	P.E. NUMBER	DATE
DESIGN-DETAILED	DESIGNER	DATE			
CHECKED-REVIEWED	CHECKER	DATE			
DESIGNS DET AILED	DESIGNER	DATE			
DESIGNS DET AILED	DESIGNER	DATE			
REVISIONS 1					
REVISIONS 2					
REVISIONS 3					
REVISIONS 4					
FIELD CHANGES					

DEXTER
ROUTE 7
CROSS SECTIONS

SHEET NUMBER
58
OF 15

Date: 12/10/2013

Username: atlee.mousseau

Division: HIGHWAY

Filename: ... \059_xsect_39-50_035.dgn

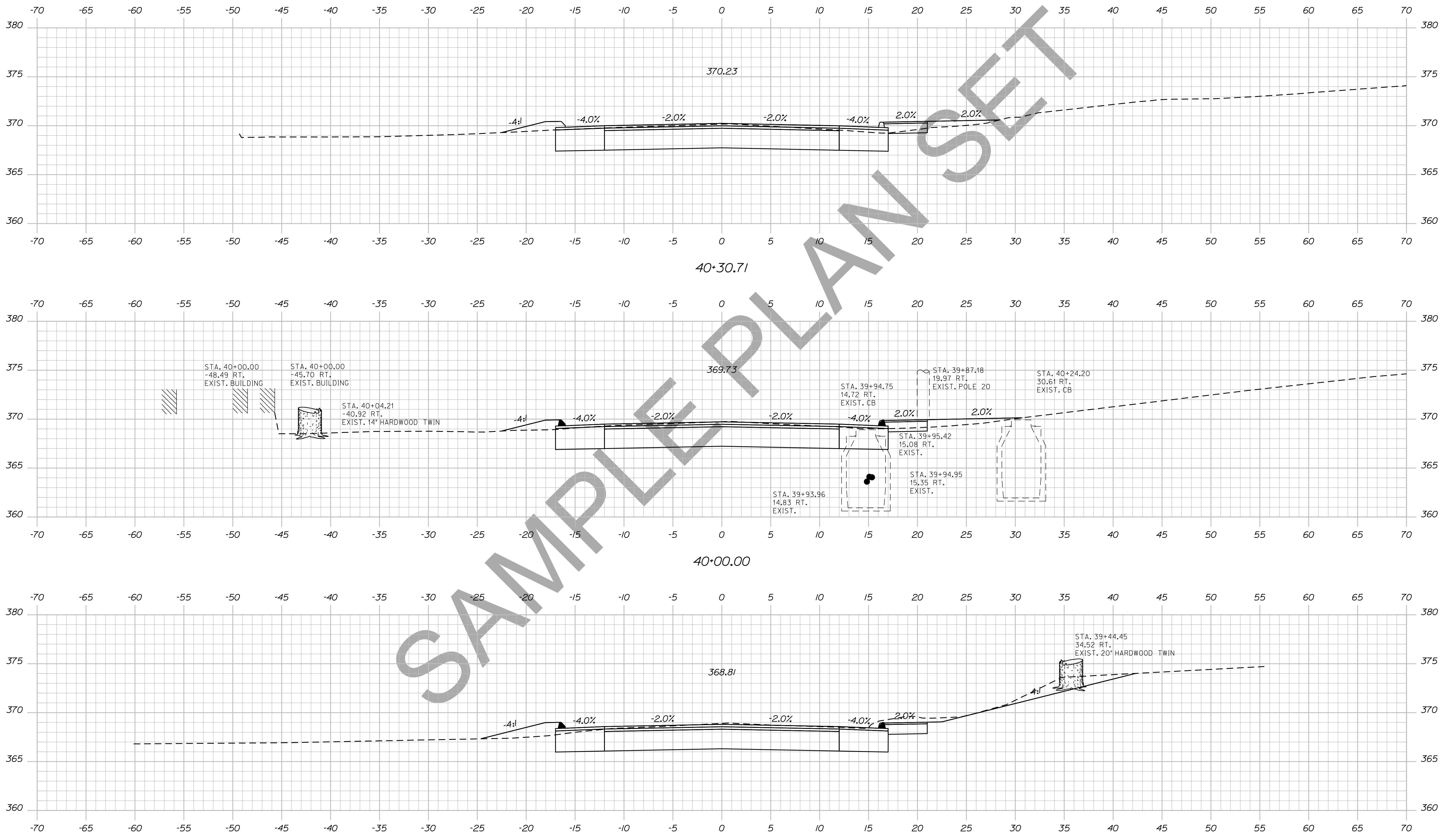

STATE OF MAINE
DEPARTMENT OF TRANSPORTATION
018246.00
WIN
PIN 18246.00
HIGHWAY PLANS

PROJ. MANAGER	BY	DATE	SIGNATURE
DESIGN-DETAILED	DESIGNER	DATE	
CHECKED-REVIEWED	CHECKER	DATE	
DESIGNS DET AILED	DESIGNER	DATE	
DESIGNS DET AILED	DESIGNER	DATE	
REVISIONS 1			
REVISIONS 2			
REVISIONS 3			
REVISIONS 4			
FIELD CHANGES			

DEXTER
ROUTE 7
CROSS SECTIONS

SHEET NUMBER
59
OF 15

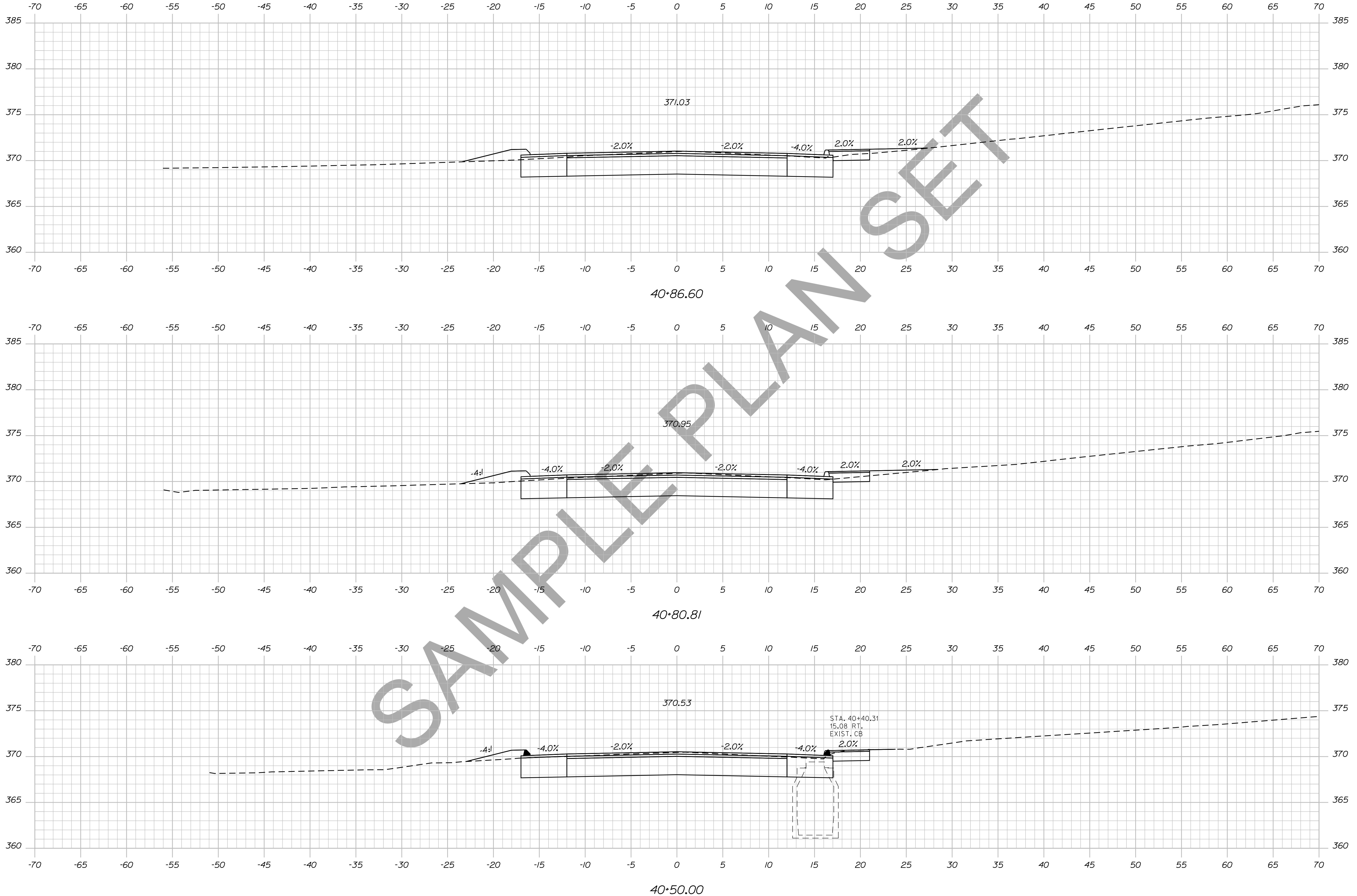

STATE OF MAINE
DEPARTMENT OF TRANSPORTATION

018246.00
WIN
PIN 18246.00
HIGHWAY PLANS

PROJ. MANAGER	DESIGNER	CHECKED	DATE	SIGNATURE	P.E. NUMBER	DATE

DEXTER
ROUTE 7
CROSS SECTIONS

SHEET NUMBER
60
OF 15

Date: 12/10/2013

Username: atlee.mousseau

Division: HIGHWAY

Filename: ... \061_Xsect_41+00_037.dgn

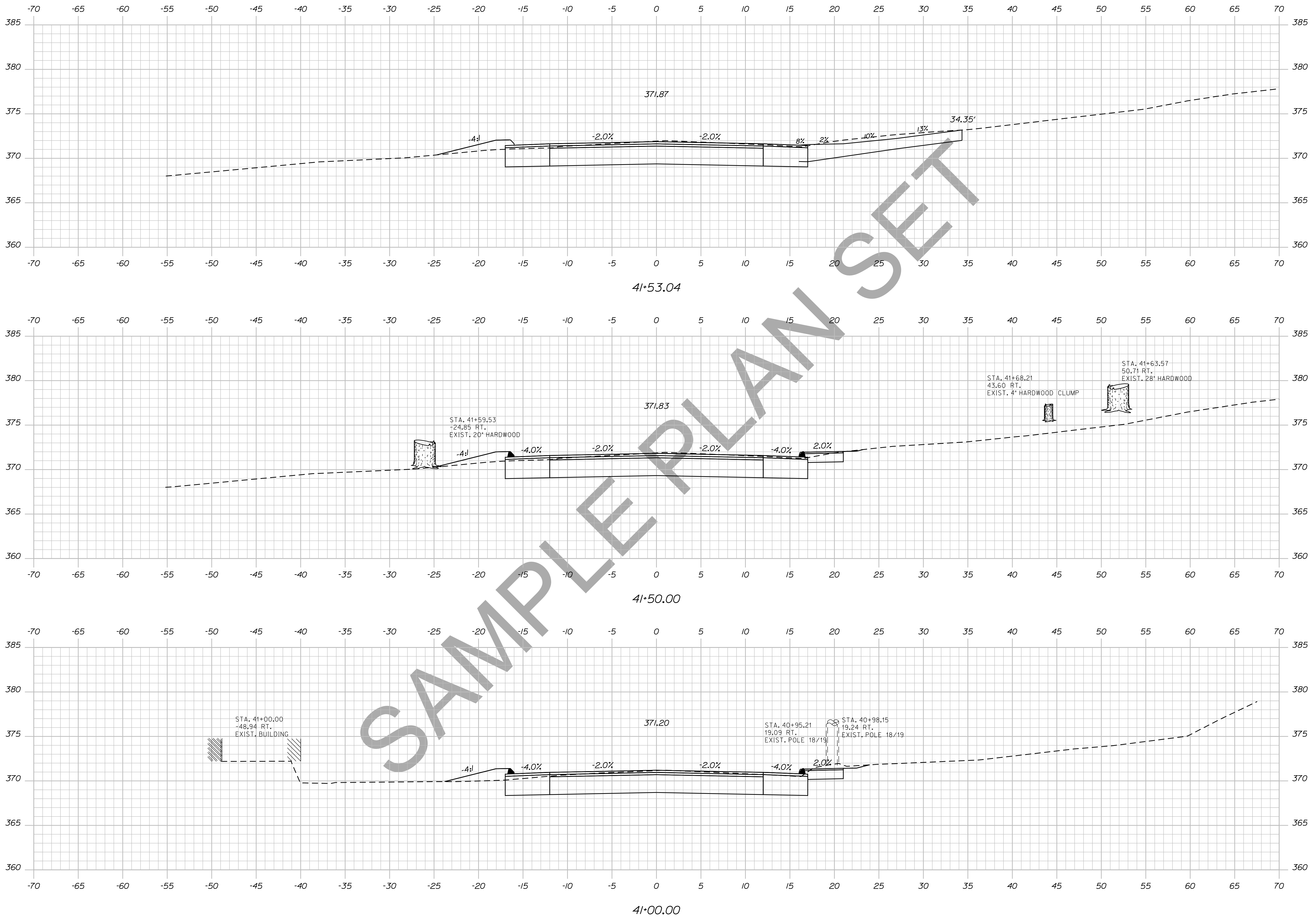

STATE OF MAINE
DEPARTMENT OF TRANSPORTATION
018246.00
WIN
PIN 18246.00
HIGHWAY PLANS

PROJ. MANAGER	DESIGN-DETAILED	CHECKED-REVIEWED	DESIGN-DETAILED	DESIGN-DETAILED	DESIGN-DETAILED	REVISIONS 1	REVISIONS 2	REVISIONS 3	REVISIONS 4	FIELD CHANGES	PROJ. MANAGER	BY	DATE	SIGNATURE	P.E. NUMBER	DATE

DEXTER
ROUTE 7
CROSS SECTIONS

SHEET NUMBER
61
OF 15

Date: 12/10/2013

Username: atlee.mousseau

Division: HIGHWAY

Filename: ... \062_xsect_41+80_038.dgn

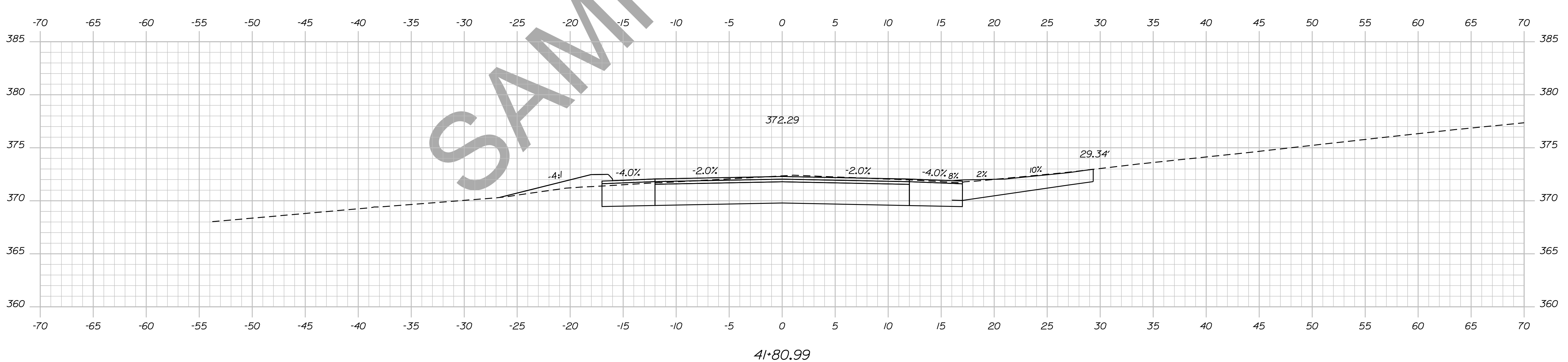
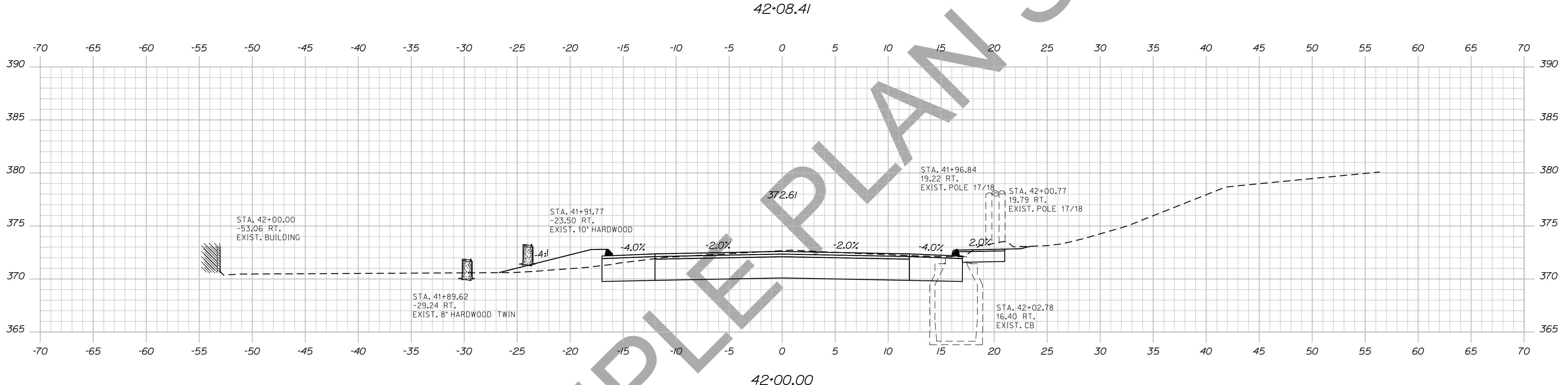
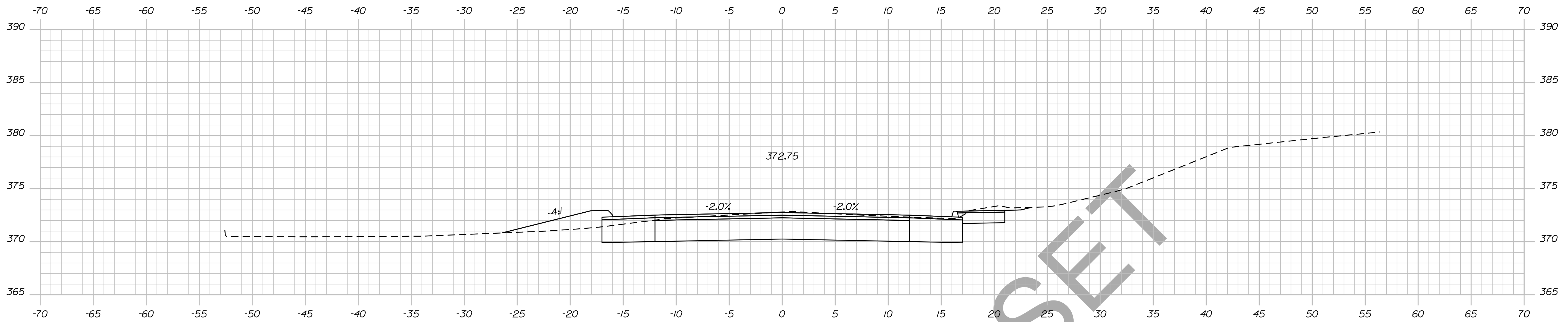

STATE OF MAINE
DEPARTMENT OF TRANSPORTATION
018246.00
WIN
PIN 18246.00
HIGHWAY PLANS

PROJ. MANAGER	BY	DATE	SIGNATURE
DESIGN DETAILED	DESIGNED	PROPOSED	
CHECKED/REVIEWED	DRAWN	PROPOSED	
DESIGNS DET AILED	DESIGNED	PROPOSED	
DESIGNS DET AILED	DESIGNED	PROPOSED	
REVISIONS 1			
REVISIONS 2			
REVISIONS 3			
REVISIONS 4			
FIELD CHANGES			

DEXTER
ROUTE 7
CROSS SECTIONS

SHEET NUMBER
62
OF 15

Filename: ... \063_Xsect_42-50_039.dgn

Division: HIGHWAY

Username: atlee.mousseau

Date: 12/10/2013

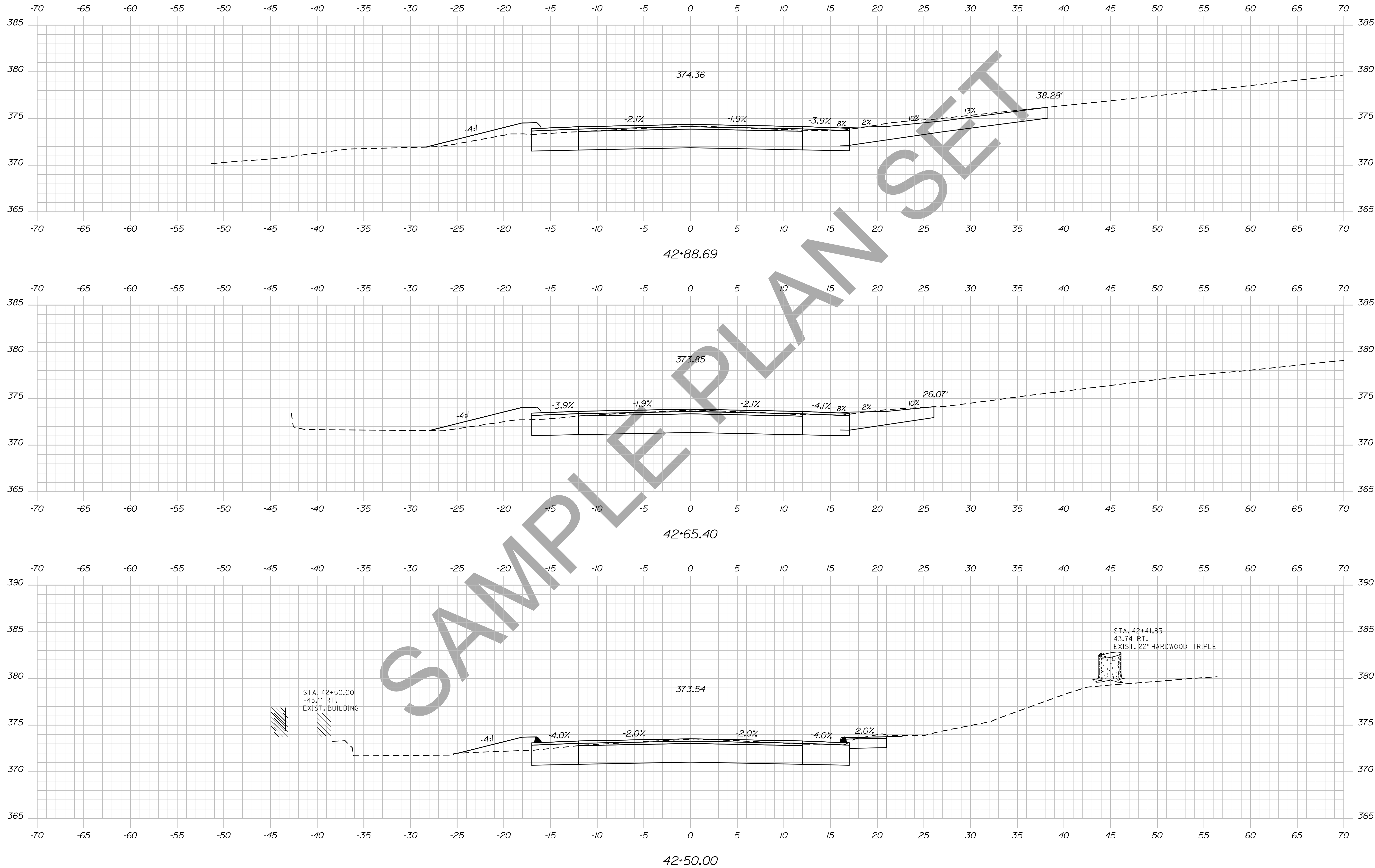

STATE OF MAINE
DEPARTMENT OF TRANSPORTATION
018246.00
WIN
PIN 18246.00
HIGHWAY PLANS

PROJ. MANAGER	BY	DATE	SIGNATURE	P.E. NUMBER	DATE
DESIGN-DETAILED	DESIGNER	DATE	SIGNATURE	P.E. NUMBER	DATE
CHECKED-REVIEWED	CHECKER	DATE	SIGNATURE	P.E. NUMBER	DATE
DESIGNS DET AILED	DESIGNER	DATE	SIGNATURE	P.E. NUMBER	DATE
DESIGNS DET AILED	DESIGNER	DATE	SIGNATURE	P.E. NUMBER	DATE
REVISIONS 1	DESIGNER	DATE	SIGNATURE	P.E. NUMBER	DATE
REVISIONS 2	DESIGNER	DATE	SIGNATURE	P.E. NUMBER	DATE
REVISIONS 3	DESIGNER	DATE	SIGNATURE	P.E. NUMBER	DATE
REVISIONS 4	DESIGNER	DATE	SIGNATURE	P.E. NUMBER	DATE
FIELD CHANGES	DESIGNER	DATE	SIGNATURE	P.E. NUMBER	DATE

DEXTER
ROUTE 7
CROSS SECTIONS

SHEET NUMBER
63
OF 15

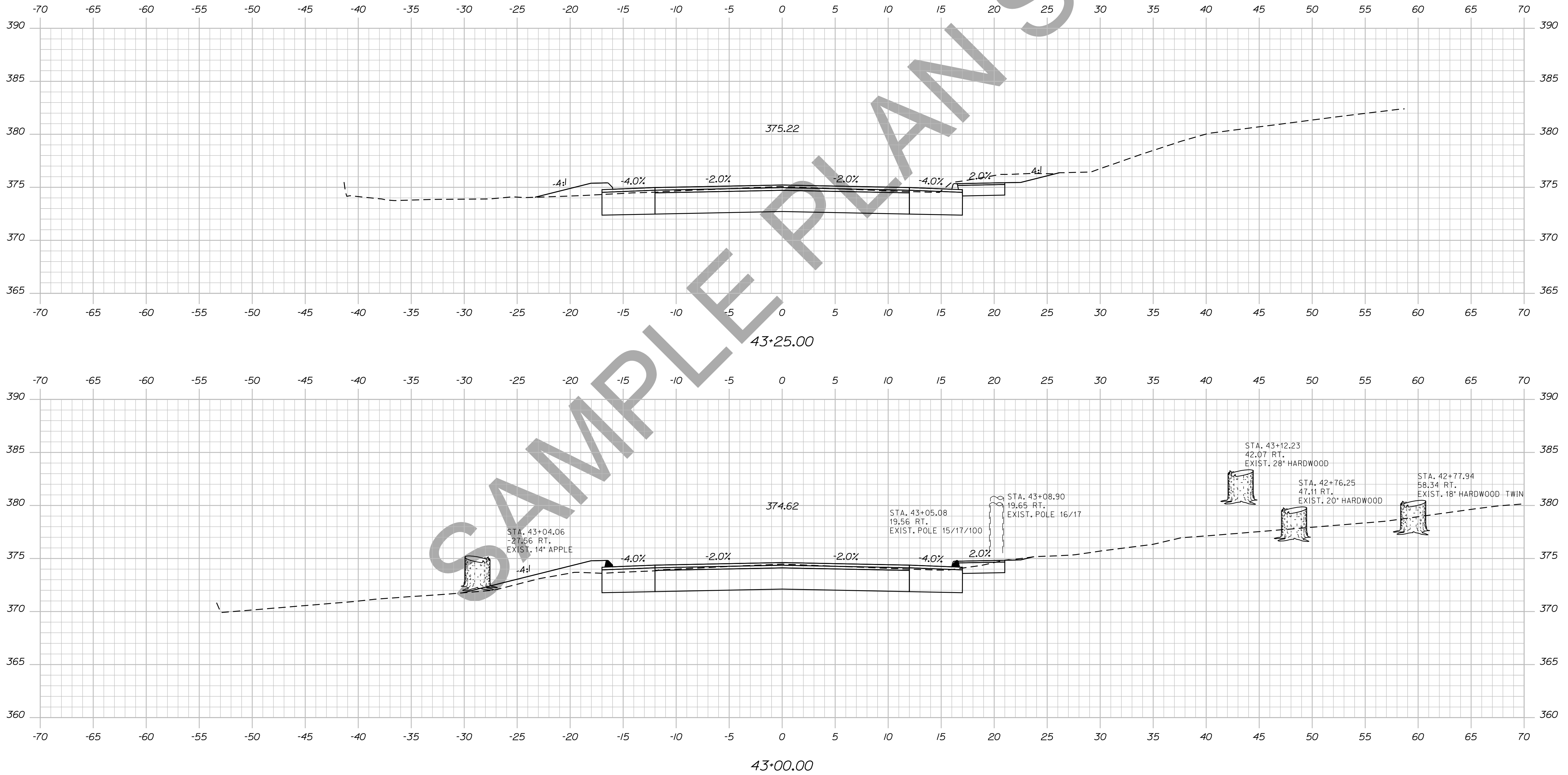

SIGNATURE

P.E. NUMBER

DATE

DATE

BY

PROJ. MANAGER

CHECKED-REVIEWED

DESIGN DETAILED

DESIGN DETAILED

DESIGN DETAILED

DESIGN DETAILED

DESIGN DETAILED

DESIGN DETAILED

DESIGN DETAILED

DESIGN DETAILED

DESIGN DETAILED

DESIGN DETAILED

DESIGN DETAILED

DESIGN DETAILED

DESIGN DETAILED

DESIGN DETAILED

DESIGN DETAILED

DESIGN DETAILED

DESIGN DETAILED

DESIGN DETAILED

DESIGN DETAILED

DESIGN DETAILED

DESIGN DETAILED

DESIGN DETAILED

DEXTER
ROUTE 7
CROSS SECTIONS

SHEET NUMBER

64

OF 15

Filename: ... \065_xsect_43-50_041.dgn

Division: HIGHWAY

Username: atlee,mousseau

Date: 12/10/2013

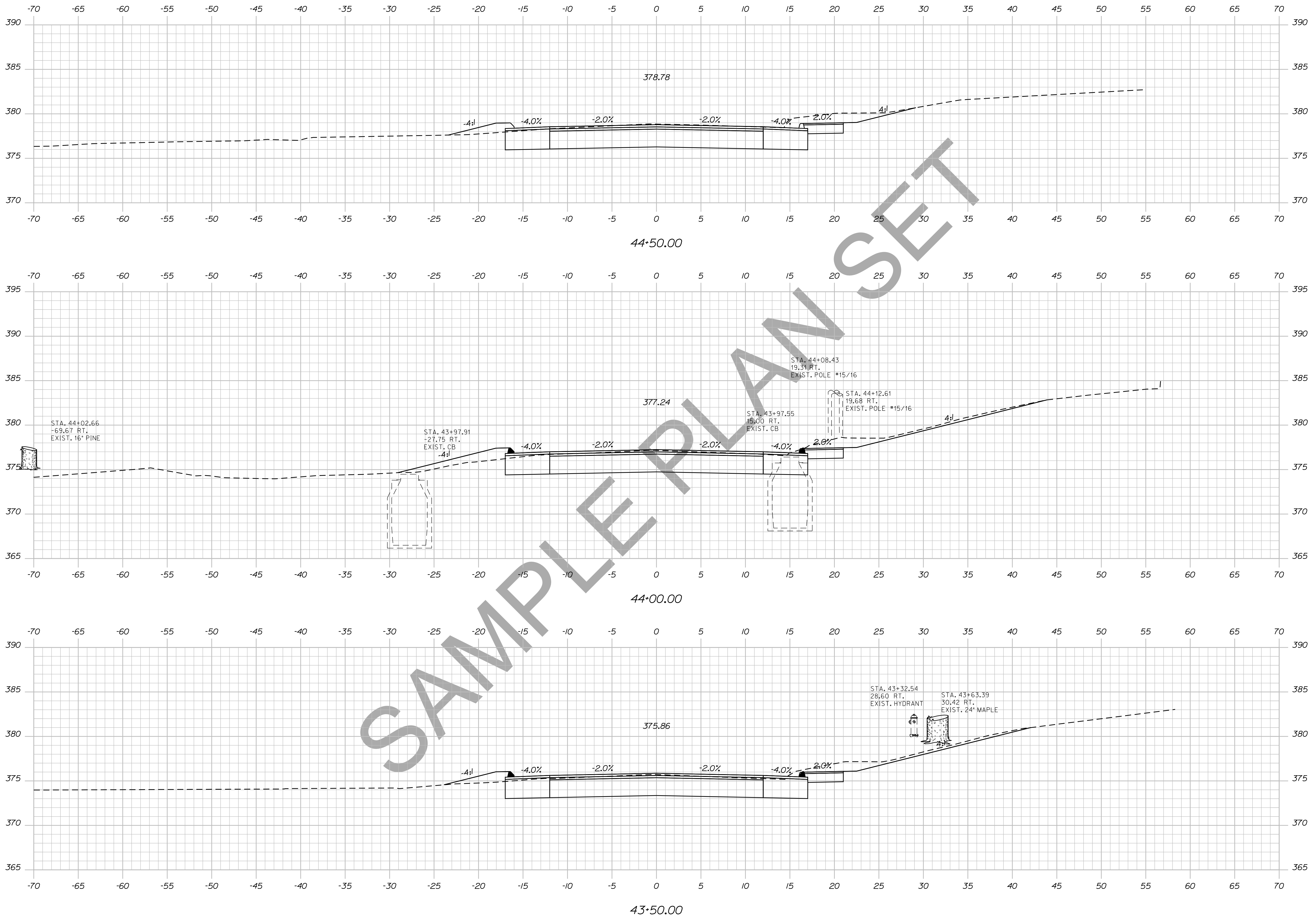

STATE OF MAINE
DEPARTMENT OF TRANSPORTATION
018246.00
WIN
PIN 18246.00
HIGHWAY PLANS

PROJ. MANAGER	BY	DATE	SIGNATURE
DESIGN-DETAILED	DESIGNER	DATE	SIGNATURE
CHECKED-REVIEWED	CHECKER	DATE	SIGNATURE
DESIGN-DETAILED	DESIGNER	DATE	SIGNATURE
DESIGN-DETAILED	DESIGNER	DATE	SIGNATURE
REVISIONS 1	REVISION	DATE	P.E. NUMBER
REVISIONS 2	REVISION	DATE	DATE
REVISIONS 3	REVISION	DATE	
REVISIONS 4	REVISION	DATE	
FIELD CHANGES	FIELD	DATE	

DEXTER
ROUTE 7
CROSS SECTIONS

SHEET NUMBER
65
OF 15

Date: 12/10/2013

Username: atlee.mousseau

Division: HIGHWAY

Filename: ... \066_Xsect_45+00_042.dgn

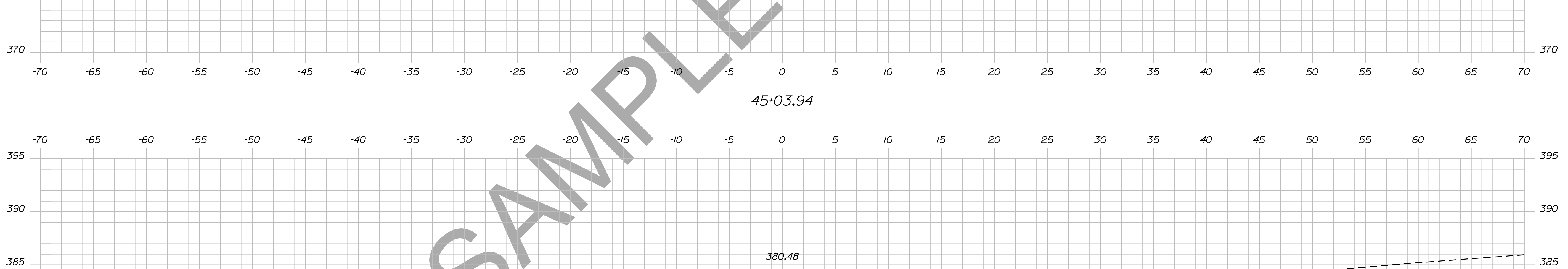
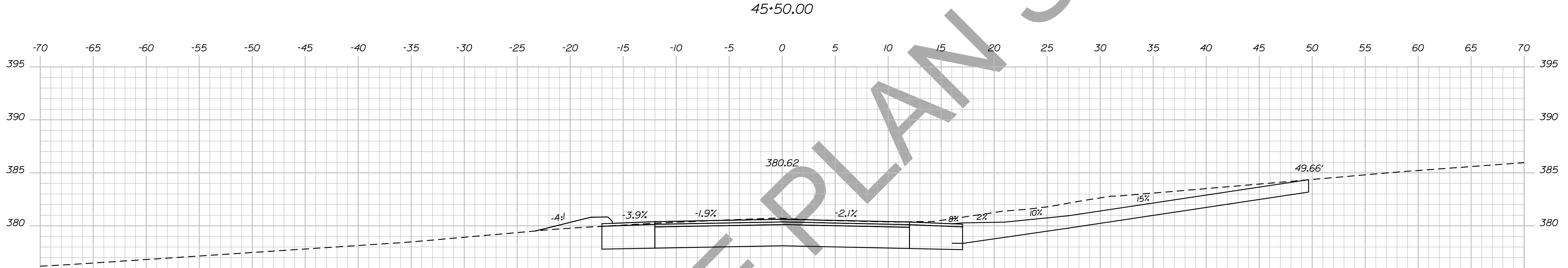
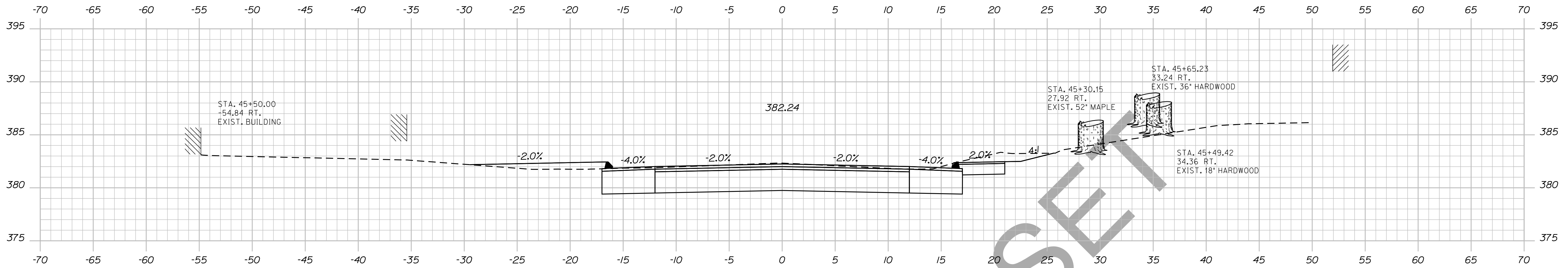

STATE OF MAINE DEPARTMENT OF TRANSPORTATION		018246-00		WIN PIN 18246.00		HIGHWAY PLANS	
PROJ. MANAGER	DESIGN-DETAILED	CHECKED-REVIEWED	DESIGN-DETAILED	DESIGN-DETAILED	REVISIONS 1	REVISIONS 2	REVISIONS 3
BY	DATE	BY	DATE	BY	DATE	BY	DATE
SIGNATURE				P.E. NUMBER			
DATE				DATE			
FIELD CHANGES				FIELD CHANGES			
DEXTER ROUTE 7				CROSS SECTIONS			
SHEET NUMBER				66			
OF 15				OF 15			

Date: 12/10/2013

Username: atlee.mousseau

Division: HIGHWAY

Filename: ... \067_xsect_45+65_043.dgn

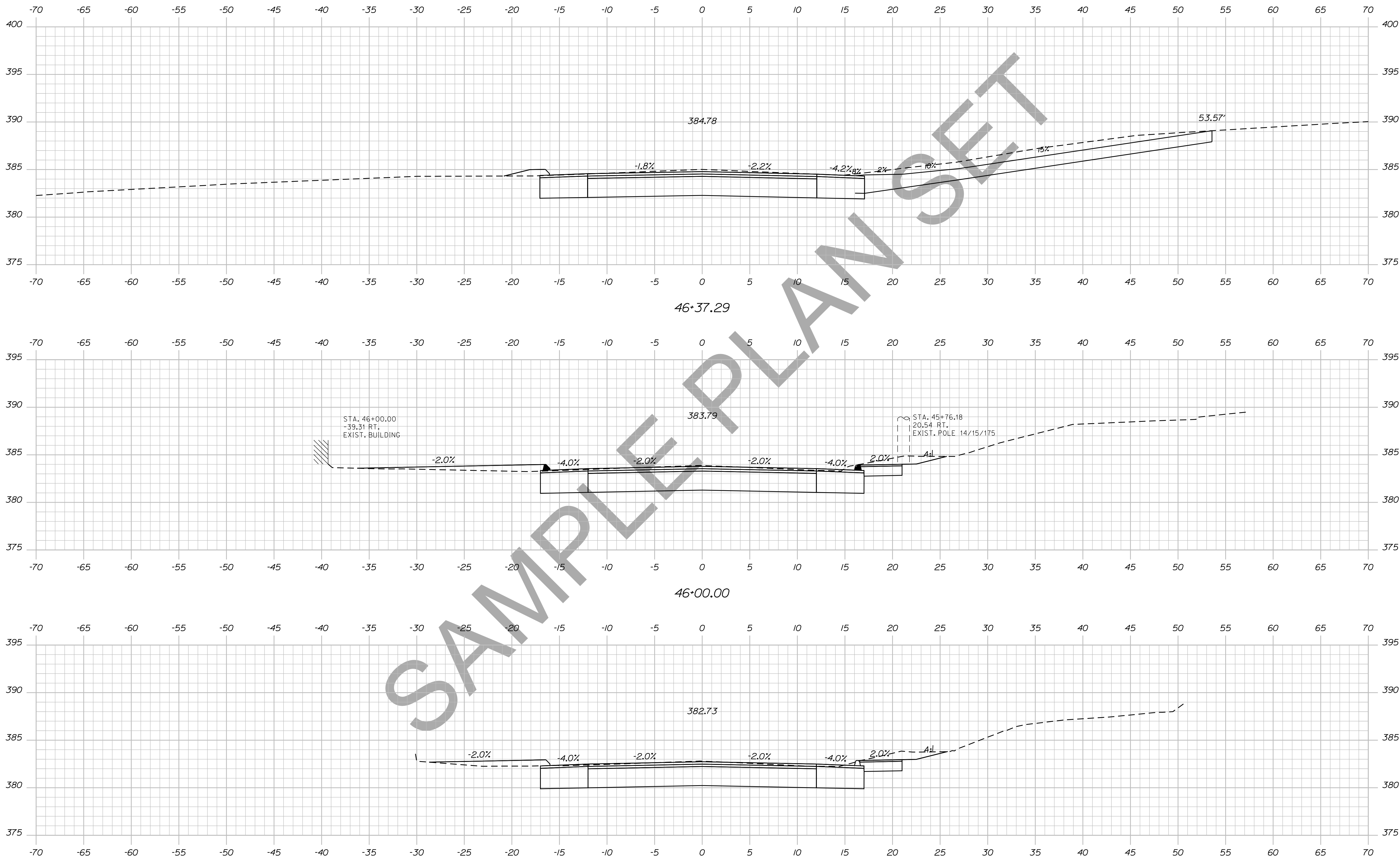

STATE OF MAINE
 DEPARTMENT OF TRANSPORTATION
 018246.00
 WIN
 PIN 18246.00
 HIGHWAY PLANS

SIGNATURE
 P.E. NUMBER
 DATE

PROJ. MANAGER	BY	DATE
DESIGN-DETAILED	DESIGNER	DATE
CHECKED-REVIEWED	CHECKER	DATE
DESIGN-DETAILED	DESIGNER	DATE
DESIGN-DETAILED	DESIGNER	DATE
REVISIONS 1	DESIGNER	DATE
REVISIONS 2	DESIGNER	DATE
REVISIONS 3	DESIGNER	DATE
REVISIONS 4	DESIGNER	DATE
FIELD CHANGES	DESIGNER	DATE

DEXTER
 ROUTE 7
 CROSS SECTIONS

SHEET NUMBER
 67
 OF 15

Date: 12/10/2013

Username: atlee.mousseau

Division: HIGHWAY

Filename: ... \068_xsect_46+46_04.dgn

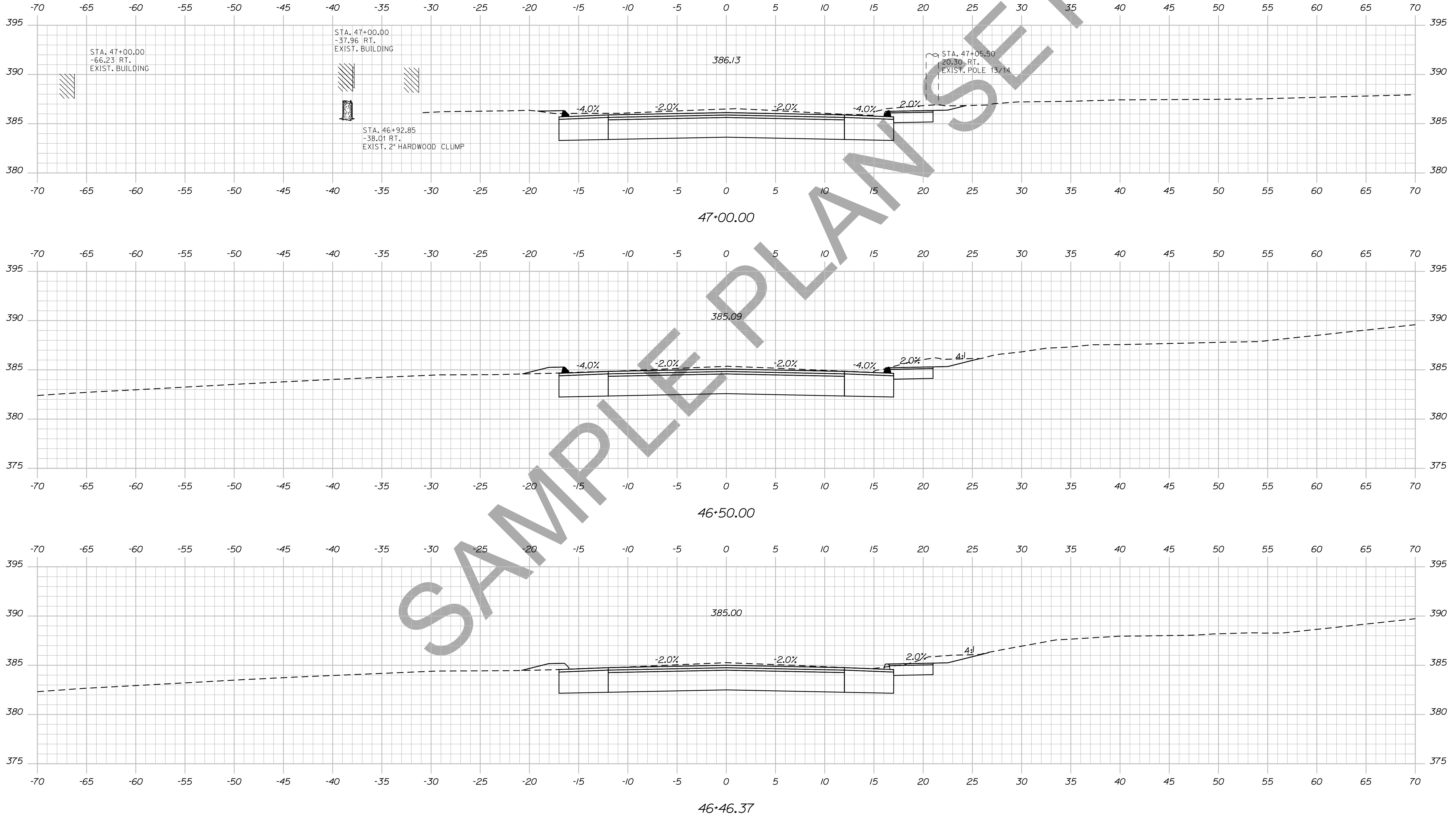

STATE OF MAINE
 DEPARTMENT OF TRANSPORTATION
 018246.00
 WIN
 PIN 18246.00
 HIGHWAY PLANS

SIGNATURE
 P.E. NUMBER
 DATE

PROJ. MANAGER	BY	DATE
DESIGN DETAILED	DESIGNER	DATE
CHECKED-REVIEWED	CHECKER	DATE
DESIGN DETAILED	DESIGNER	DATE
DESIGN DETAILED	DESIGNER	DATE
REVISIONS 1	DESIGNER	DATE
REVISIONS 2	DESIGNER	DATE
REVISIONS 3	DESIGNER	DATE
REVISIONS 4	DESIGNER	DATE
FIELD CHANGES	DESIGNER	DATE

DEXTER
 ROUTE 7
 CROSS SECTIONS

SHEET NUMBER
 68
 OF 15

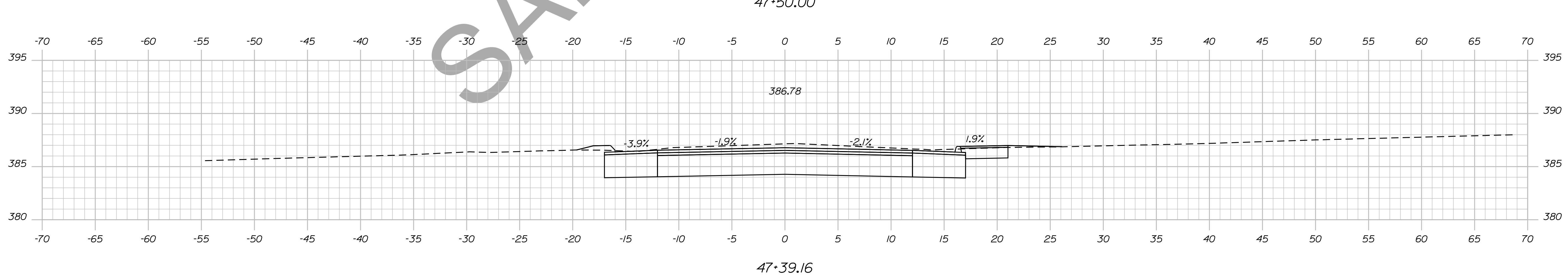
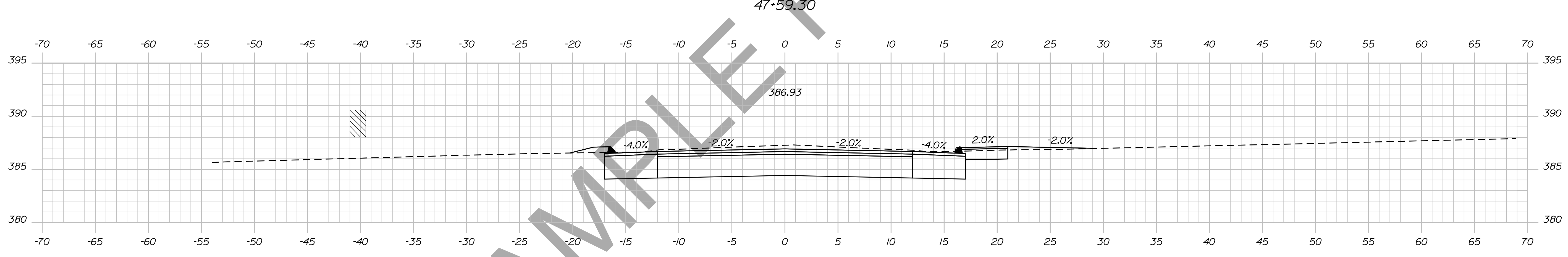
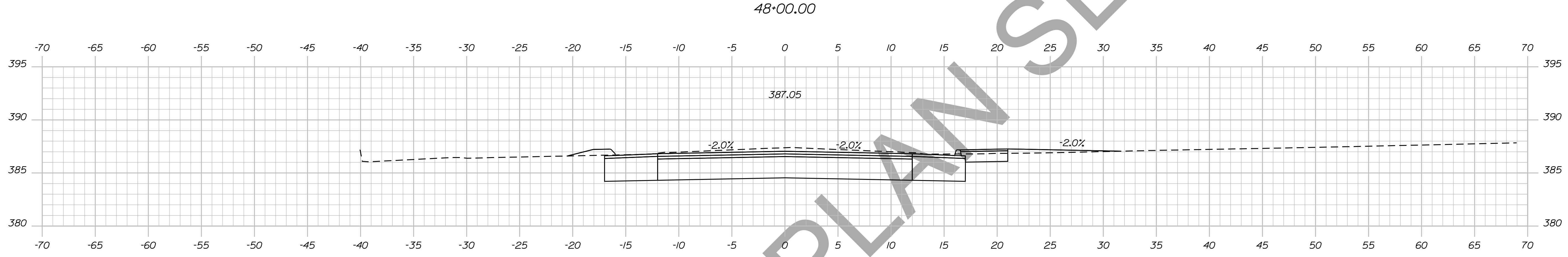
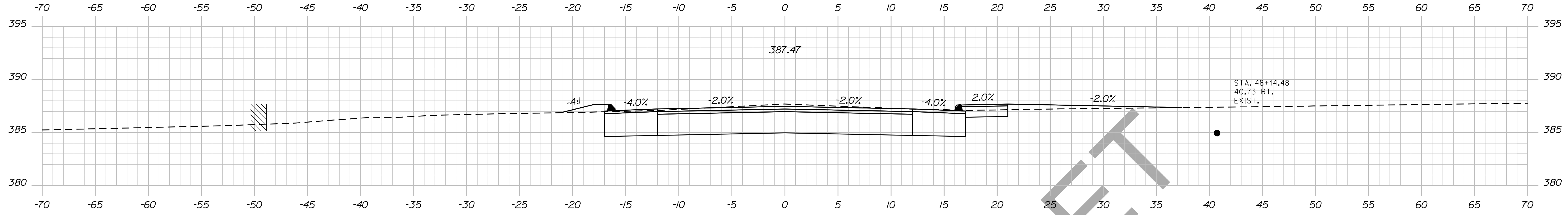

STATE OF MAINE
DEPARTMENT OF TRANSPORTATION
018246.00
WIN
PIN 18246.00
HIGHWAY PLANS

PROJ. MANAGER	DESIGN-DETAILED	CHECKED-REVIEWED	DESIGNS DET. TAILED	REVISIONS 1	REVISIONS 2	REVISIONS 3	REVISIONS 4	FIELD CHANGES	BY	DATE	SIGNATURE	P.E. NUMBER	DATE

DEXTER
ROUTE 7
CROSS SECTIONS

SHEET NUMBER
69
OF 15

Date: 12/10/2013

Username: atlee.mousseau

Division: HIGHWAY

Filename: ... \070_xsect_48-02_046.dgn

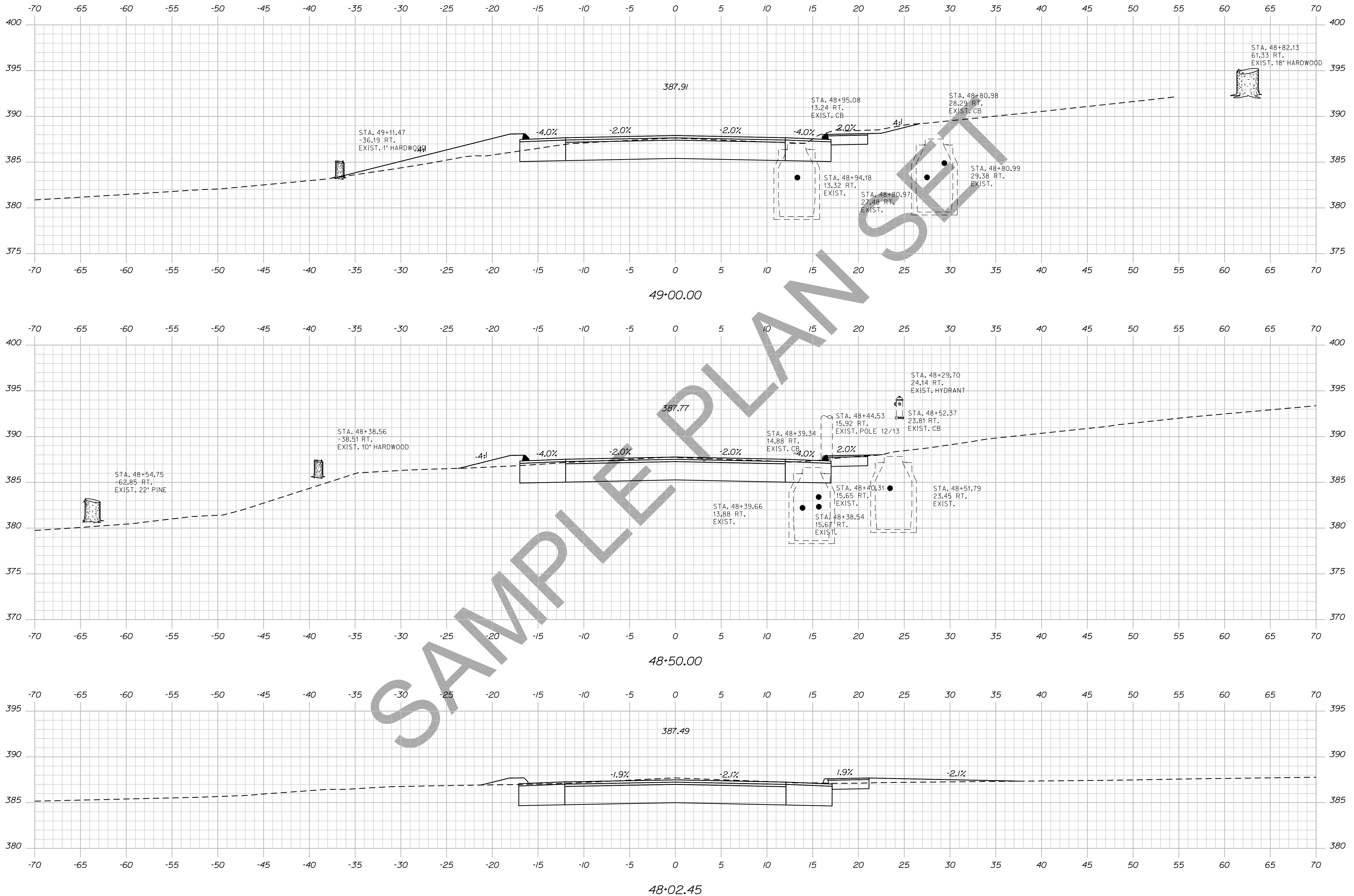

STATE OF MAINE		DEPARTMENT OF TRANSPORTATION	
018246-00		WIN	
PIN 18246.00		HIGHWAY PLANS	
	CROSS SECTIONS		
DEXTER ROUTE 70			
SHEET NUMBER			
70			
OF 15			

PROJ. MANAGER	BY	DATE	SIGNATURE	P.E. NUMBER	DATE
DESIGN DETAILED	DESIGNER	DATE			
CHECKED-REVIEWED	CHECKER	DATE			
DESIGNS DET AILED	DESIGNER	DATE			
DESIGNS DET AILED	DESIGNER	DATE			
REVISIONS 1					
REVISIONS 2					
REVISIONS 3					
REVISIONS 4					
FIELD CHANGES					

Date: 12/10/2013

Username: atlee.mousseau

Division: HIGHWAY

Filename: ... \071_Xsect_49+50_047.dgn

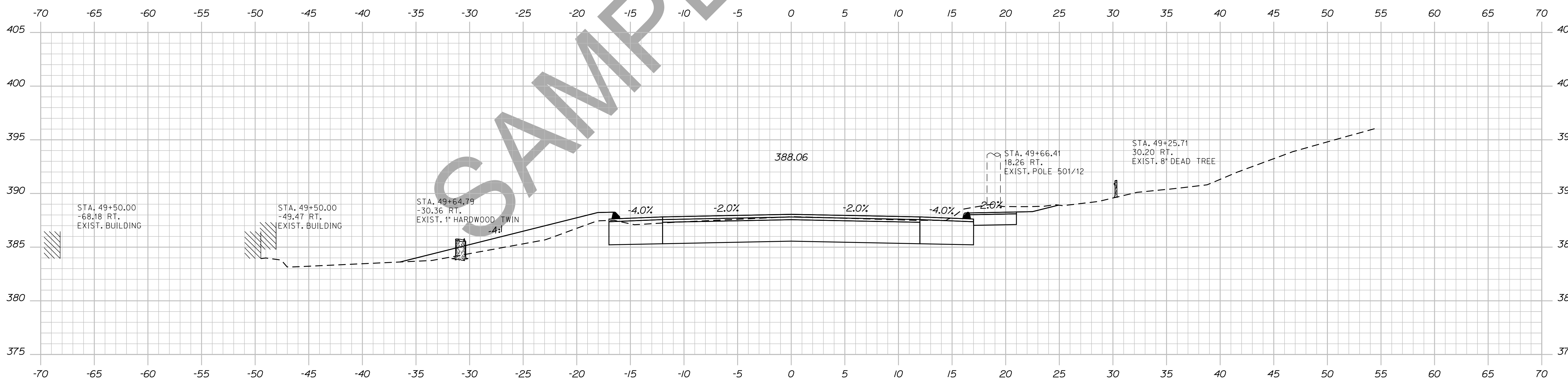
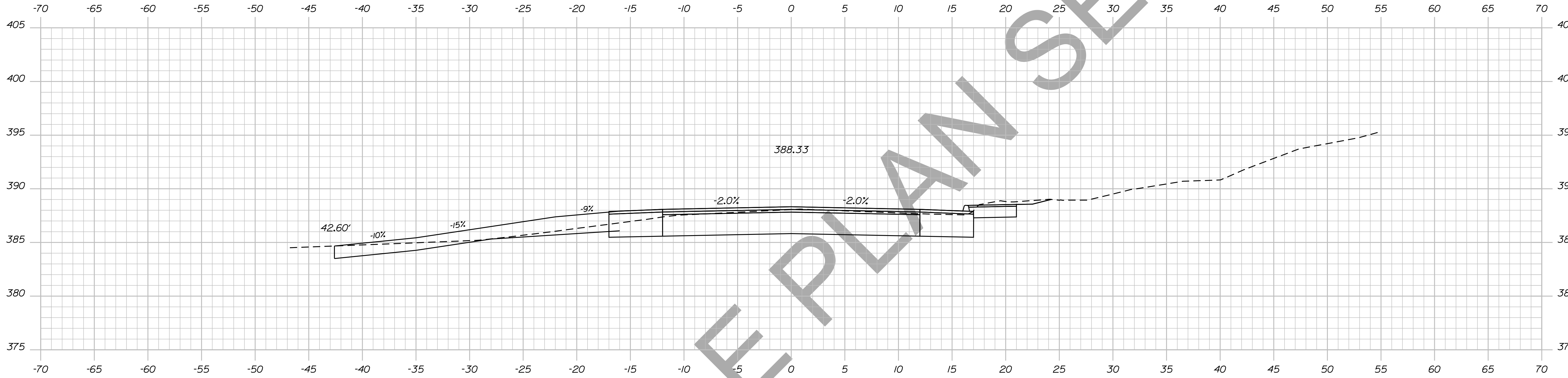

STATE OF MAINE
DEPARTMENT OF TRANSPORTATION
018246.00
WIN
PIN 18246.00
HIGHWAY PLANS

PROJ. MANAGER	DESIGN-DETAILED	CHECKED-REVIEWED	DESIGN-DETAILED	DESIGN-DETAILED	REVISIONS 1	REVISIONS 2	REVISIONS 3	REVISIONS 4	FIELD CHANGES

BY	DATE	SIGNATURE	P.E. NUMBER	DATE

DEXTER
ROUTE 7
CROSS SECTIONS

SHEET NUMBER
71
OF 15

Filename: ... \072_xsect_50+00_048.dgn

Division: HIGHWAY

Username: atlee,mousseau

Date: 12/10/2013

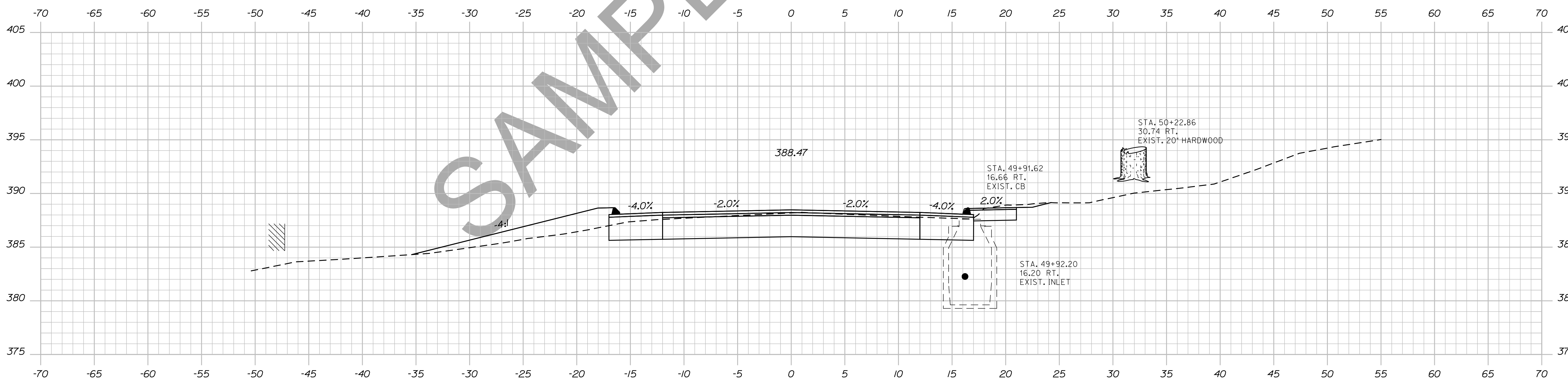
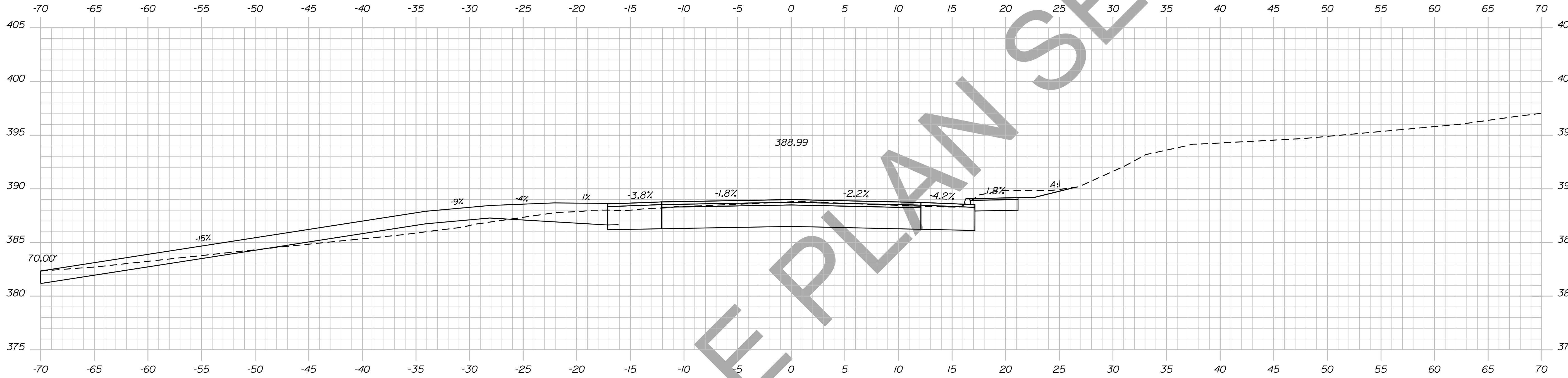

STATE OF MAINE
DEPARTMENT OF TRANSPORTATION
018246.00
WIN
PIN 18246.00
HIGHWAY PLANS

PROJ. MANAGER	BY	DATE	SIGNATURE
DESIGN-DETAILED	DESIGNER	DATE	
CHECKED-REVIEWED	CHECKER	DATE	
DESIGN-DETAILED	DESIGNER	DATE	
DESIGN-DETAILED	DESIGNER	DATE	
REVISIONS 1	REVISION	DATE	
REVISIONS 2	REVISION	DATE	
REVISIONS 3	REVISION	DATE	
REVISIONS 4	REVISION	DATE	
FIELD CHANGES	FIELD	DATE	

DEXTER
ROUTE 7
CROSS SECTIONS

SHEET NUMBER
72
OF 15

Date: 12/10/2013

Username: atlee.mousseau

Division: HIGHWAY

Filename: ... \073_xsect_50-50_049.dgn

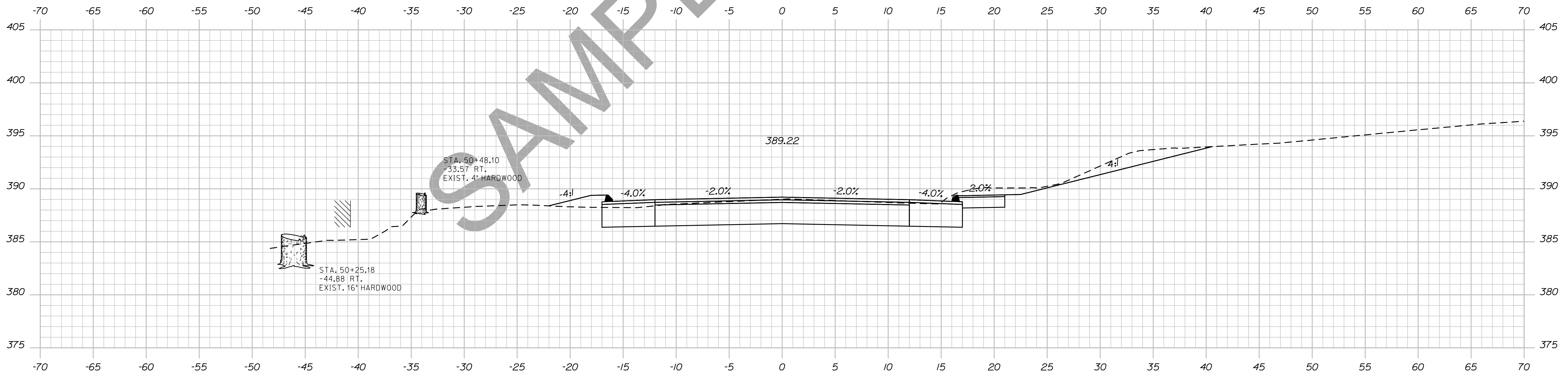
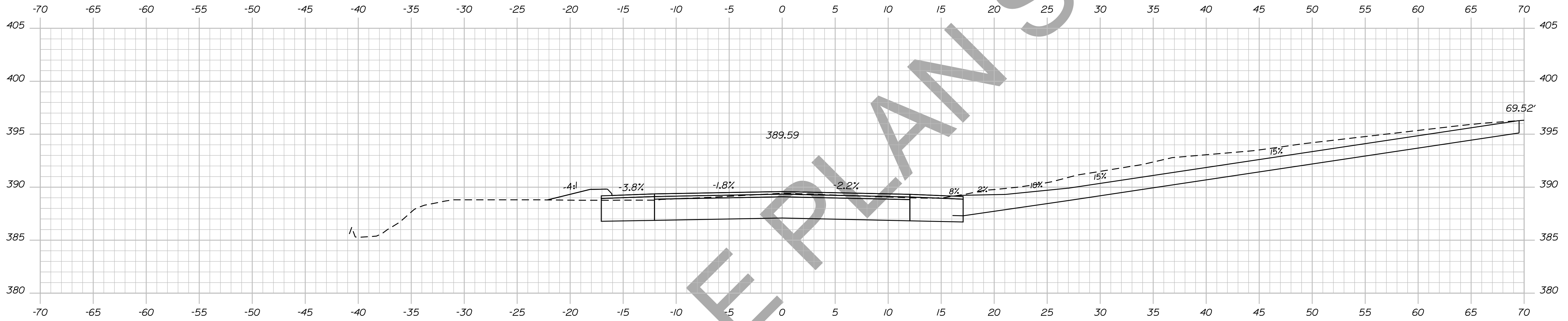

STATE OF MAINE
DEPARTMENT OF TRANSPORTATION
018246.00
WIN
PIN 18246.00
HIGHWAY PLANS

PROJ. MANAGER	BY	DATE
DESIGN-DETAILED	DESIGNER	DATE
CHECKED-REVIEWED	DESIGNER	DATE
DESIGN-DETAILED	DESIGNER	DATE
DESIGN-DETAILED	DESIGNER	DATE
REVISIONS 1	DESIGNER	DATE
REVISIONS 2	DESIGNER	DATE
REVISIONS 3	DESIGNER	DATE
REVISIONS 4	DESIGNER	DATE
FIELD CHANGES	DESIGNER	DATE

DEXTER
ROUTE 7
CROSS SECTIONS

SHEET NUMBER
73
OF 15

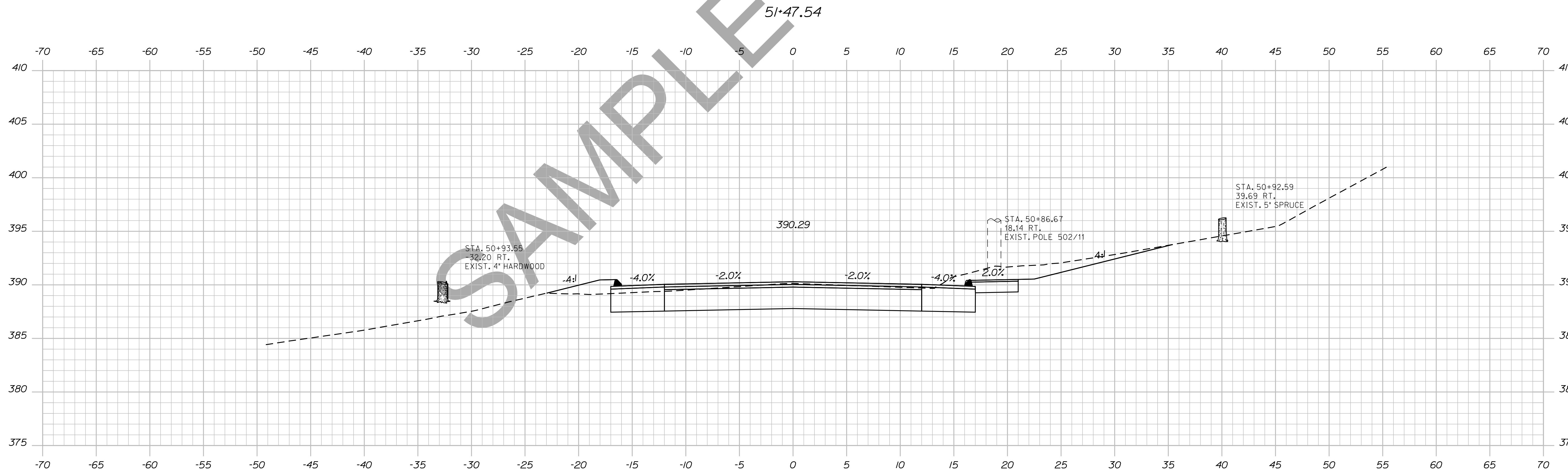

STATE OF MAINE DEPARTMENT OF TRANSPORTATION		
018246.00		
WIN PIN 18246.00		
HIGHWAY PLANS		
PROJ. MANAGER	BY	DATE
CHECKED-REVIEWED	DESIGNER	DATE
DESIGNS DET AILED	DESIGNER	DATE
DESIGNS DET AILED	DESIGNER	DATE
REVISIONS 1	DESIGNER	DATE
REVISIONS 2	DESIGNER	DATE
REVISIONS 3	DESIGNER	DATE
REVISIONS 4	DESIGNER	DATE
FIELD CHANGES	DESIGNER	DATE
SIGNATURE		DATE
P.E. NUMBER		DATE

DEXTER
ROUTE 7
CROSS SECTIONS

SHEET NUMBER
74
OF 15

Date: 12/10/2013

Username: atlee.mousseau

Division: HIGHWAY

Filename: ... \075_Xsect_51+50_051.dgn

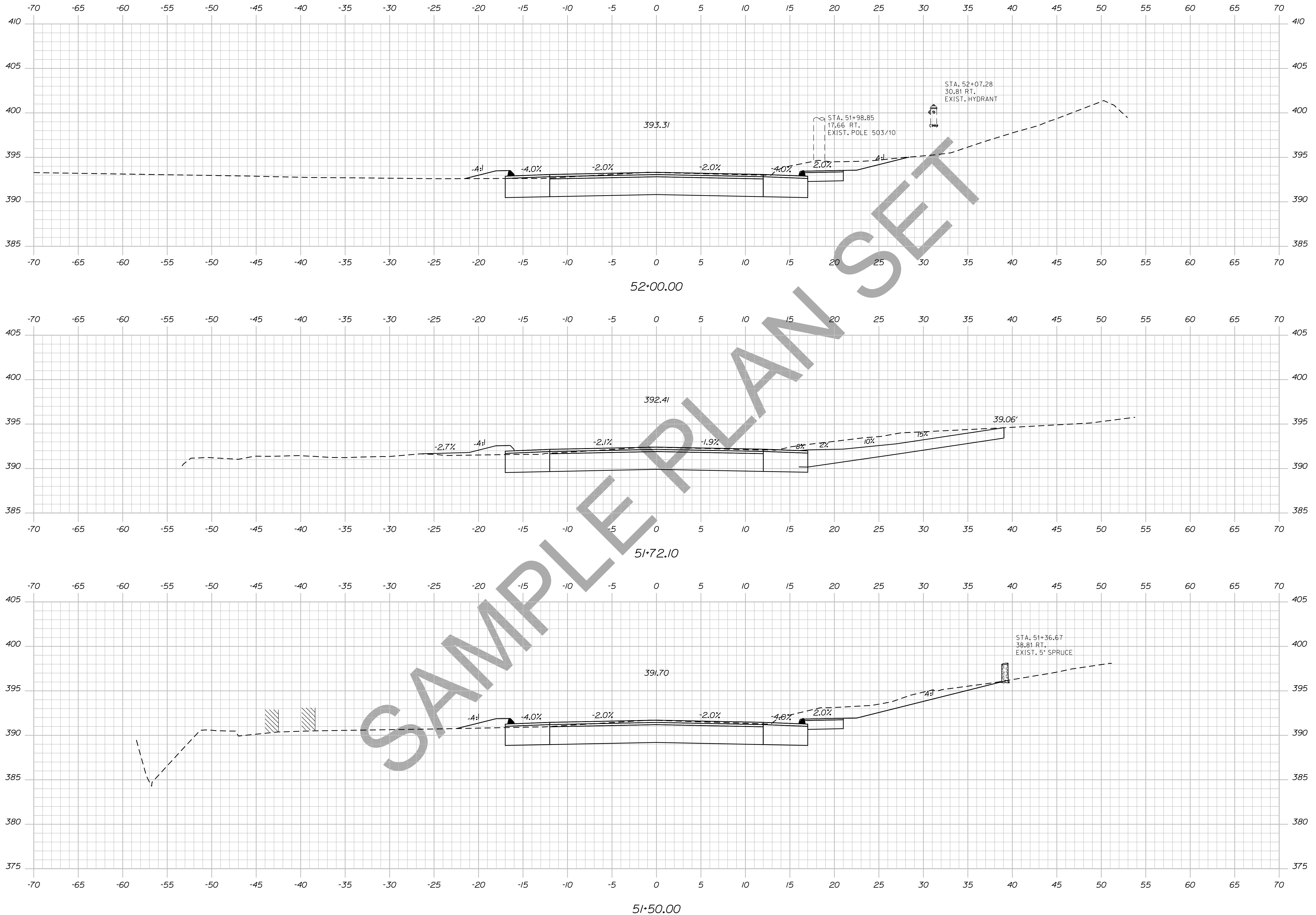

STATE OF MAINE
 DEPARTMENT OF TRANSPORTATION
 018246.00
 WIN
 PIN 18246.00
 HIGHWAY PLANS

PROJ. MANAGER	PROJ. MANAGER'S	BY	DATE	SIGNATURE
DESIGN DETAILED	DESIGNER'S	DATE	DATE	
CHECKED-REVIEWED	CHECKER'S	DATE	DATE	
DESIGN DET AILED	DESIGNER'S	DATE	DATE	
DESIGN DET AILED	DESIGNER'S	DATE	DATE	
REVISIONS 1	REVISOR'S	DATE	DATE	
REVISIONS 2	REVISOR'S	DATE	DATE	
REVISIONS 3	REVISOR'S	DATE	DATE	
REVISIONS 4	REVISOR'S	DATE	DATE	
FIELD CHANGES	FIELD CHANGES			

DEXTER
 ROUTE 7
 CROSS SECTIONS

SHEET NUMBER
 75
 OF 15

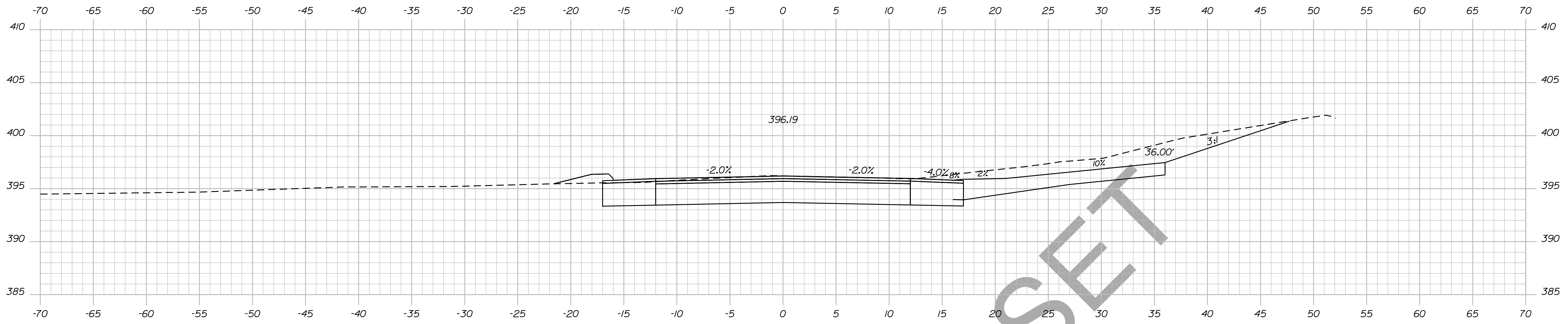

STATE OF MAINE
DEPARTMENT OF TRANSPORTATION
018246.00
WIN
PIN 18246.00
HIGHWAY PLANS

PROJ. MANAGER	DESIGNER	CHECKED	DATE

DEXTER
ROUTE 7
CROSS SECTIONS

SHEET NUMBER
76
OF 15

Username: atlee,mousseau Date:12/10/2013

Division: HIGHWAY

Filename: ... \077_xsect_53+00_053.dgn

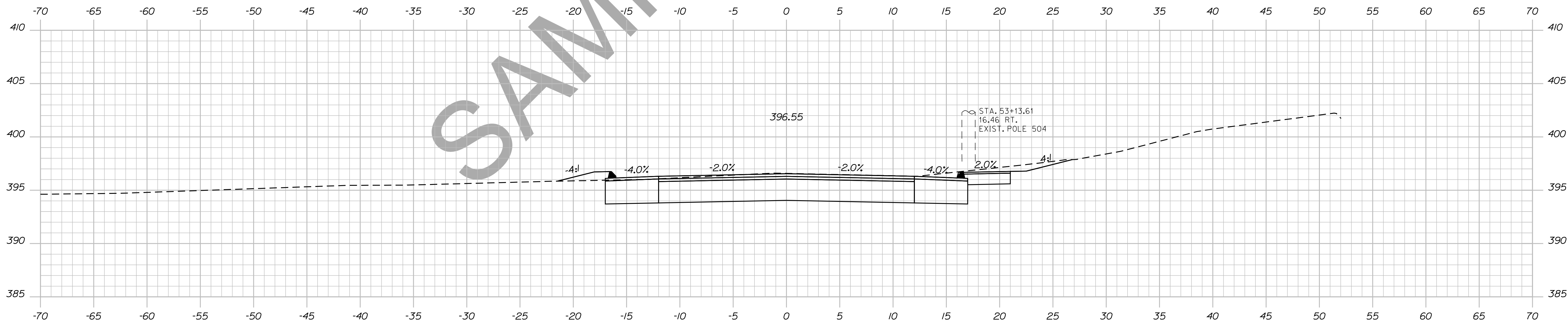
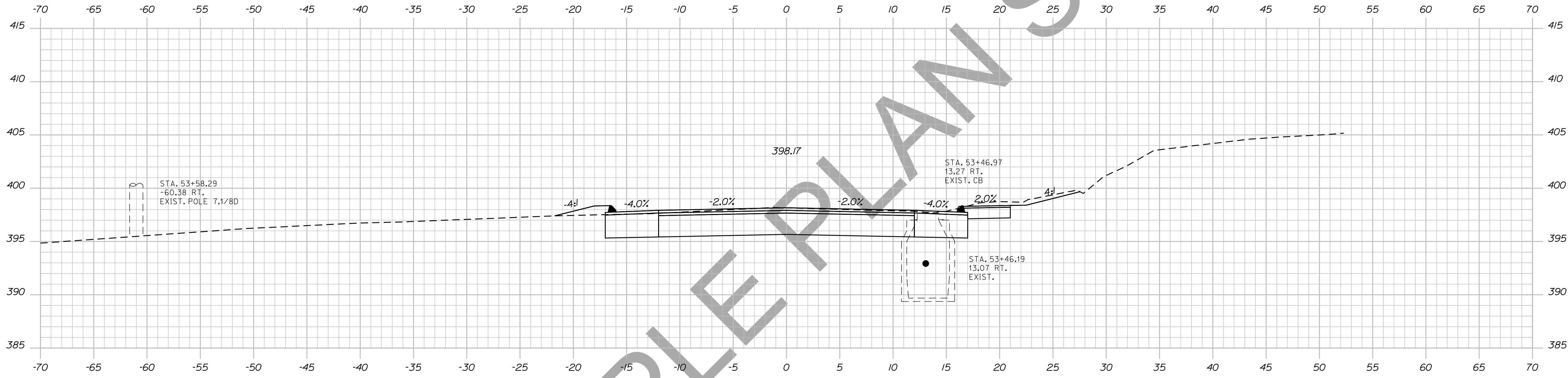

SAMPLE PLAN SET

STATE OF MAINE
DEPARTMENT OF TRANSPORTATION
018246.00
WIN
PIN 18246.00
HIGHWAY PLANS

PROJ. MANAGER	BY	DATE	SIGNATURE
DESIGN-DETAILED	DESIGNER	DATE	
CHECKED-REVIEWED	CHECKER	DATE	
DESIGN-DETAILED	DESIGNER	DATE	
DESIGN-DETAILED	DESIGNER	DATE	
REVISIONS 1			
REVISIONS 2			
REVISIONS 3			
REVISIONS 4			
FIELD CHANGES			

DEXTER
ROUTE 7
CROSS SECTIONS

SHEET NUMBER
77
OF 15

Username: atlee.mousseau Date: 12/10/2013

Division: HIGHWAY

Filename: ... \078_Xsect_54+00_054.dgn

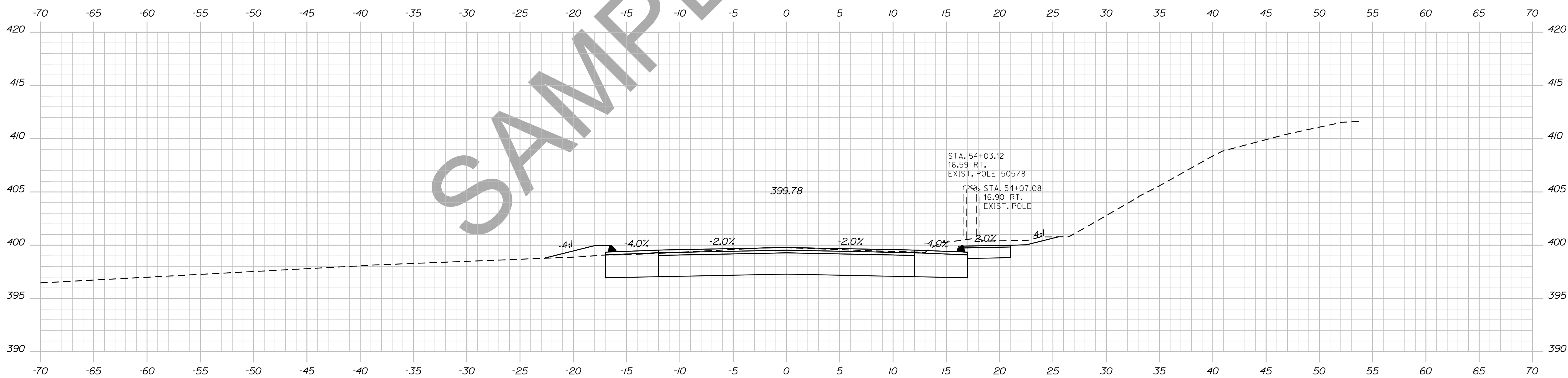
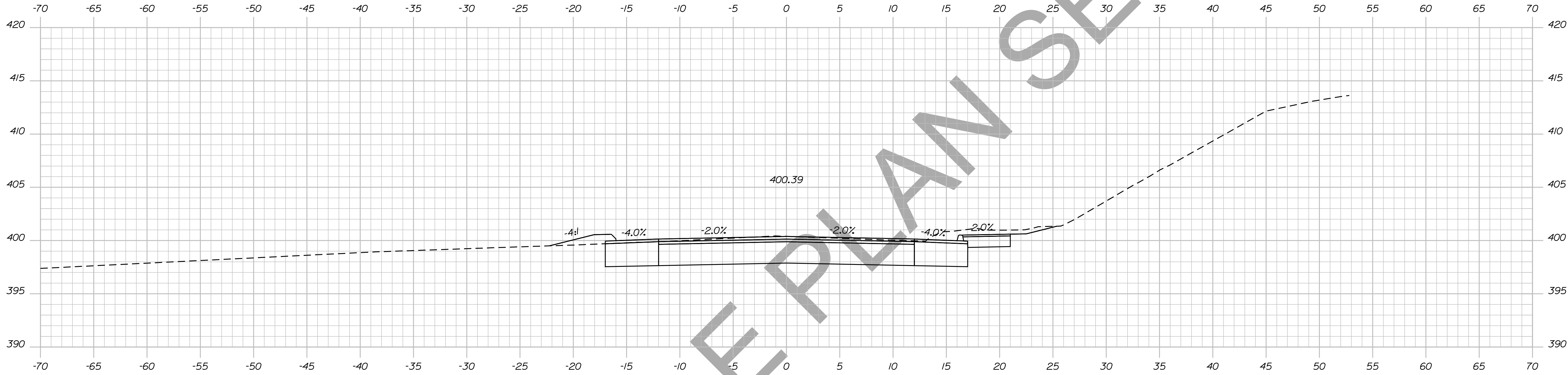

SAMPLE PLAN SET

STATE OF MAINE
DEPARTMENT OF TRANSPORTATION
018246.00
WIN
PIN 18246.00
HIGHWAY PLANS

DESIGN-DETAILED	DESIGNER	DATE	SIGNATURE	
CHECKED-REVIEWED	CHECKER	DATE		
DESIGNS DET AILED	DESIGNER	DATE		P.E. NUMBER
DESIGNS DET AILED	DESIGNER	DATE		DATE
REVISIONS 1	---	---	---	
REVISIONS 2	---	---	---	
REVISIONS 3	---	---	---	
REVISIONS 4	---	---	---	
FIELD CHANGES	---	---	---	

DEXTER
ROUTE 7
CROSS SECTIONS

SHEET NUMBER
78
OF 15

Sta. 54+00.00 to Sta. 54+19.36

Date: 12/10/2013

Username: atlee.mousseau

Division: HIGHWAY

Filename: ... \079_xsect_54+50_055.dgn

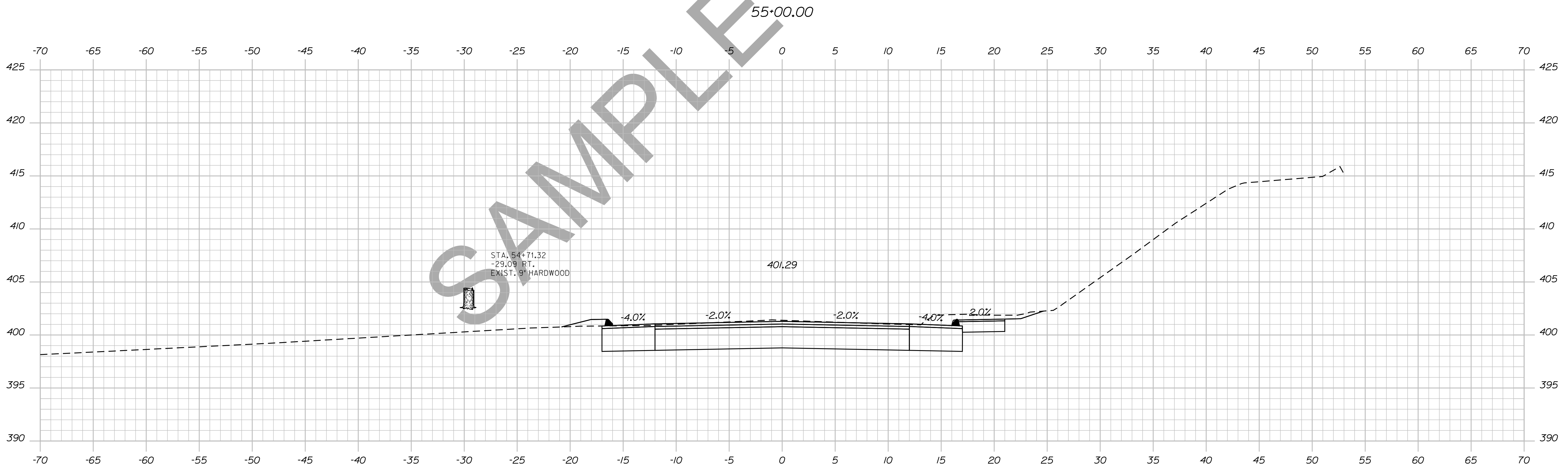
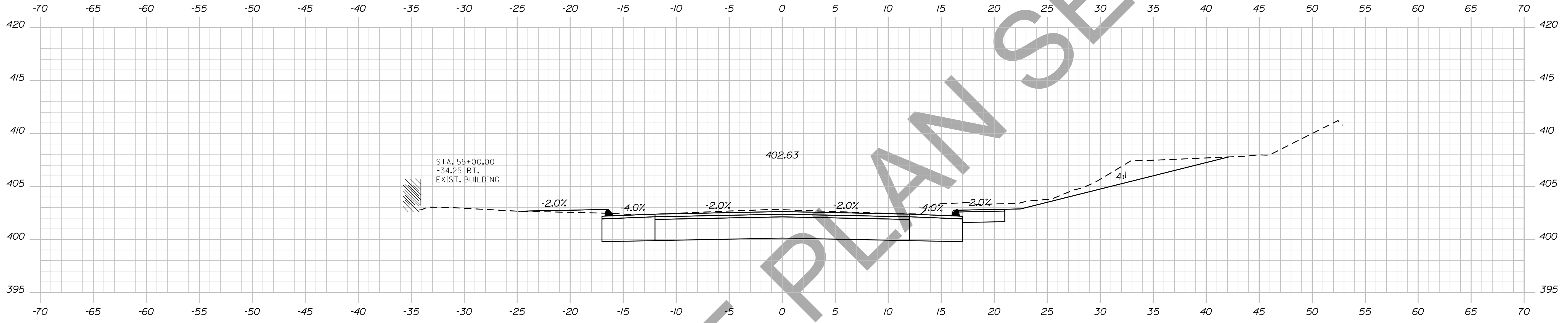

SAMPLE PLAN SET

STATE OF MAINE
DEPARTMENT OF TRANSPORTATION
018246.00
WIN
PIN 18246.00
HIGHWAY PLANS

PROJ. MANAGER	BY	DATE	SIGNATURE
CHECKED-REVIEWED	DESIGNER	DATE	P.E. NUMBER
DESIGN DETAIL	DESIGNER	DATE	DATE
DESIGN DETAIL	DESIGNER	DATE	
REVISIONS 1			
REVISIONS 2			
REVISIONS 3			
REVISIONS 4			
FIELD CHANGES			

DEXTER
ROUTE 7
CROSS SECTIONS

SHEET NUMBER
79
OF 15

Date: 12/10/2013

Username: atlee.mousseau

Division: HIGHWAY

Filename: ... \080_xsect_55-02_056.dgn

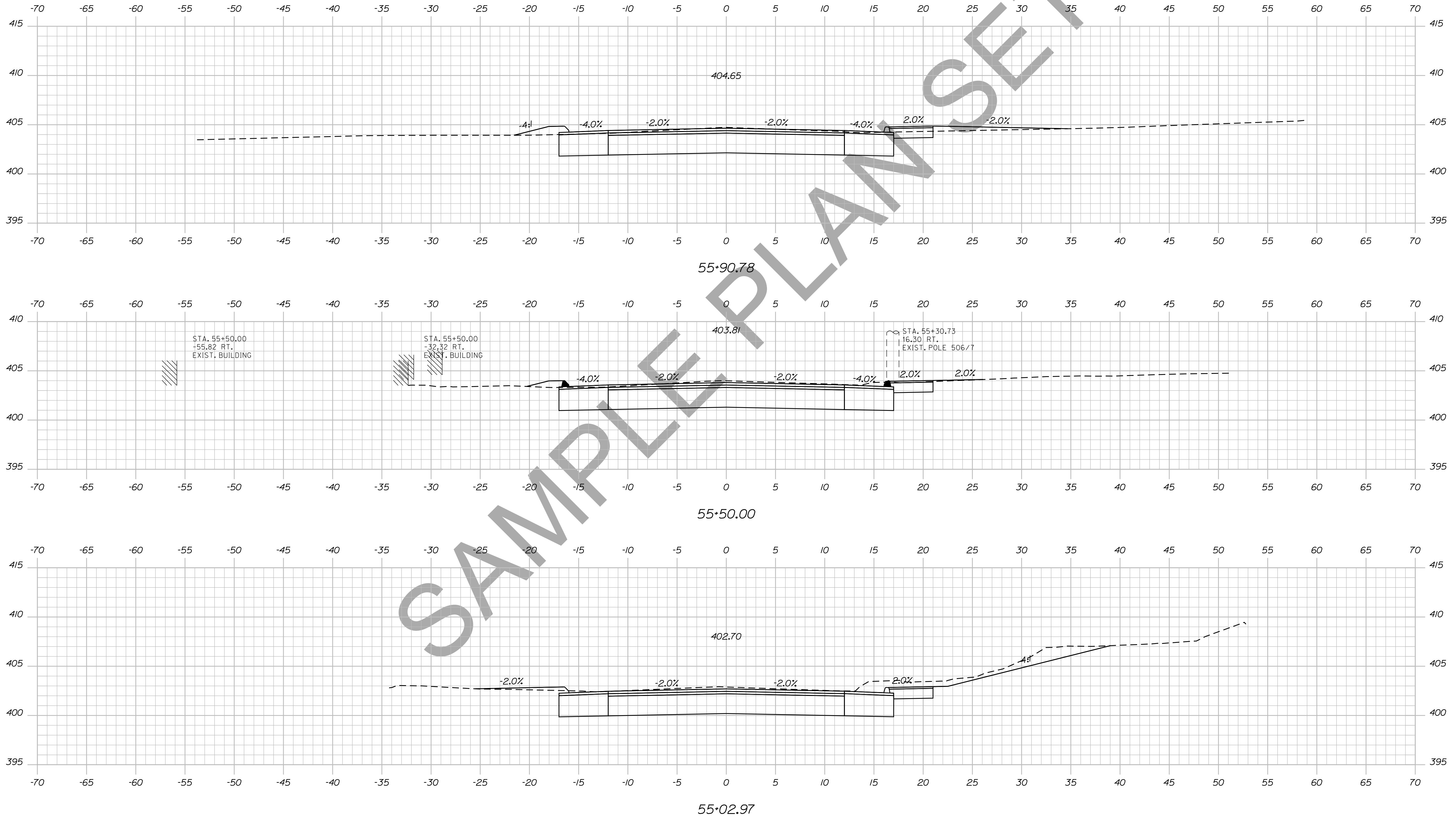

STATE OF MAINE
DEPARTMENT OF TRANSPORTATION
018246.00
WIN
PIN 18246.00
HIGHWAY PLANS

PROJ. MANAGER	BY	DATE	SIGNATURE
DESIGN-DETAILED	DESIGNER	DATE	
CHECKED-REVIEWED	CHECKER	DATE	
DESIGN-DETAILED	DESIGNER	DATE	
DESIGN-DETAILED	DESIGNER	DATE	
REVISIONS 1	REVISOR	DATE	
REVISIONS 2	REVISOR	DATE	
REVISIONS 3	REVISOR	DATE	
REVISIONS 4	REVISOR	DATE	
FIELD CHANGES	FIELD	DATE	

DEXTER
ROUTE 7
CROSS SECTIONS

SHEET NUMBER
80
OF 15

Date: 12/10/2013

Username: atlee.mousseau

Division: HIGHWAY

Filename: ... \081_Xsect_56+00_057.dgn

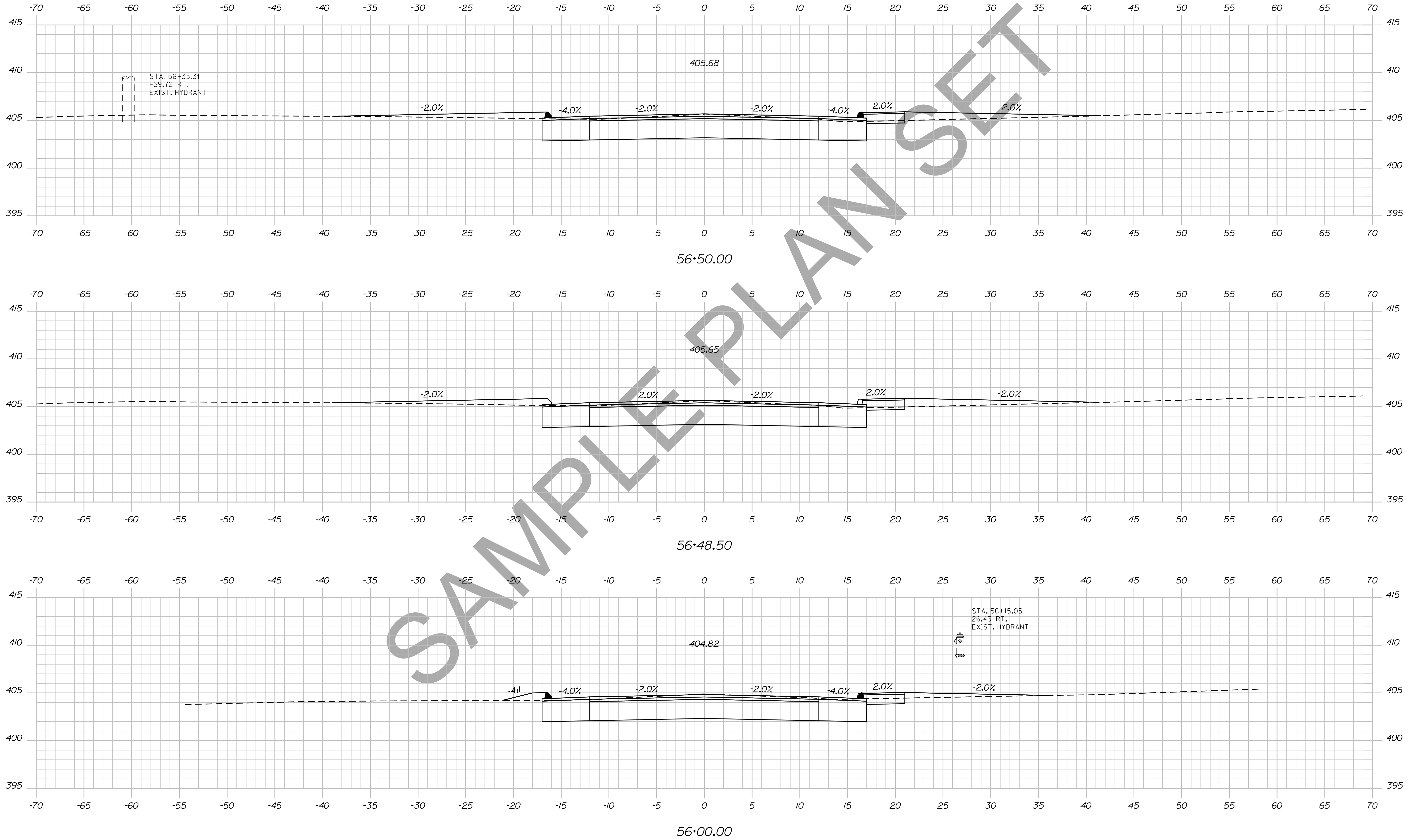

STATE OF MAINE
DEPARTMENT OF TRANSPORTATION

018246.00

WIN
PIN 18246.00

HIGHWAY PLANS

SIGNATURE

P.E. NUMBER

DATE

DATE

BY

PROJ. MANAGER
DESIGN-DETAILED
CHECKED-REVIEWED
DESIGN-DETAILED
DESIGN-DETAILED
REVISIONS 1
REVISIONS 2
REVISIONS 3
REVISIONS 4
FIELD CHANGES

DESIGNER

CHECKER

DESIGNER

CHECKER

REVISIONS 1

REVISIONS 2

REVISIONS 3

REVISIONS 4

FIELD CHANGES

DATE

DATE

DATE

DATE

DEXTER
ROUTE 7

CROSS SECTIONS

SHEET NUMBER

81

OF 15

Username: atlee.mousseau Date: 12/10/2013

Division: HIGHWAY

Filename: ... \082_xsect_57+00_058.dgn

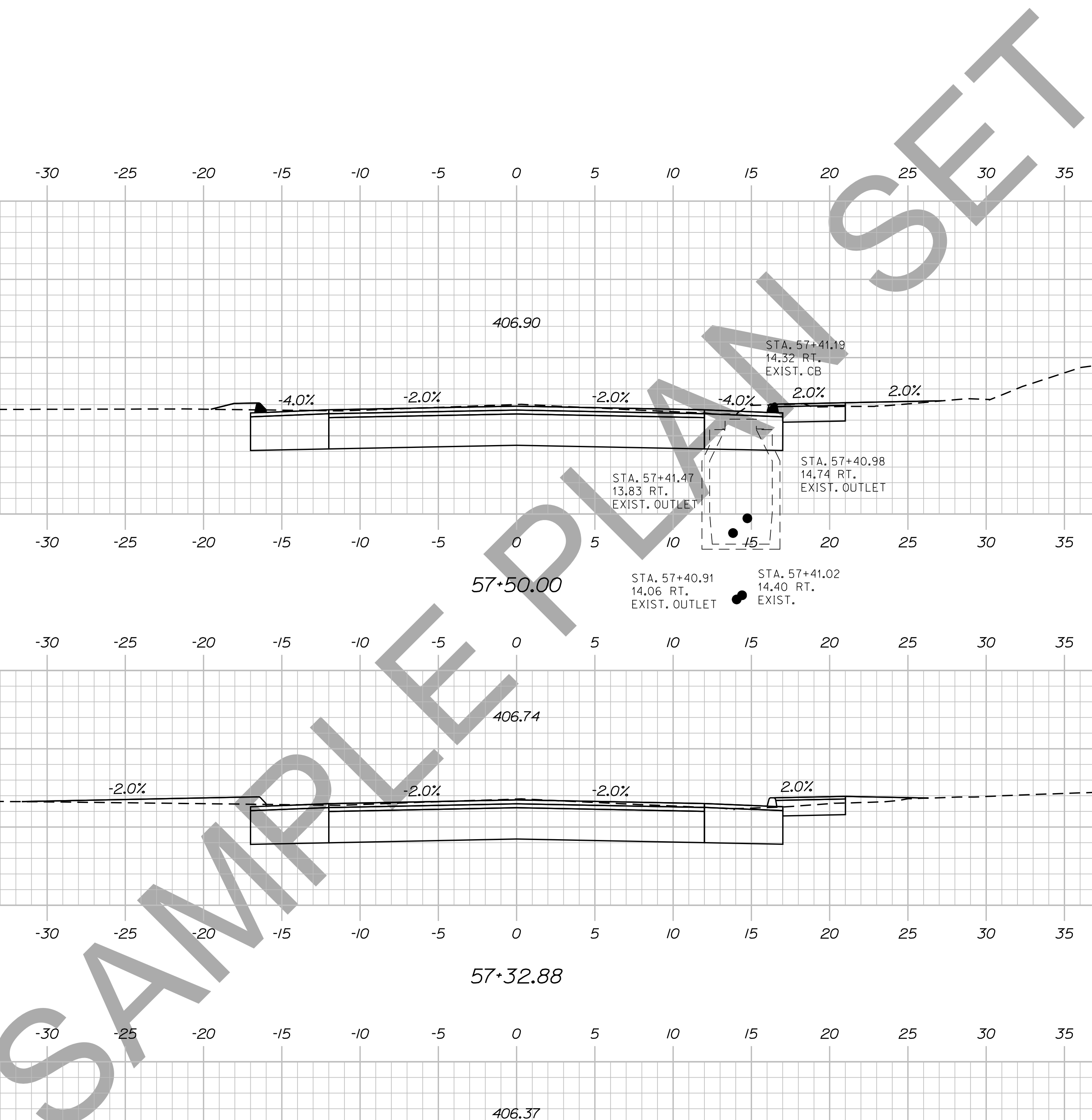
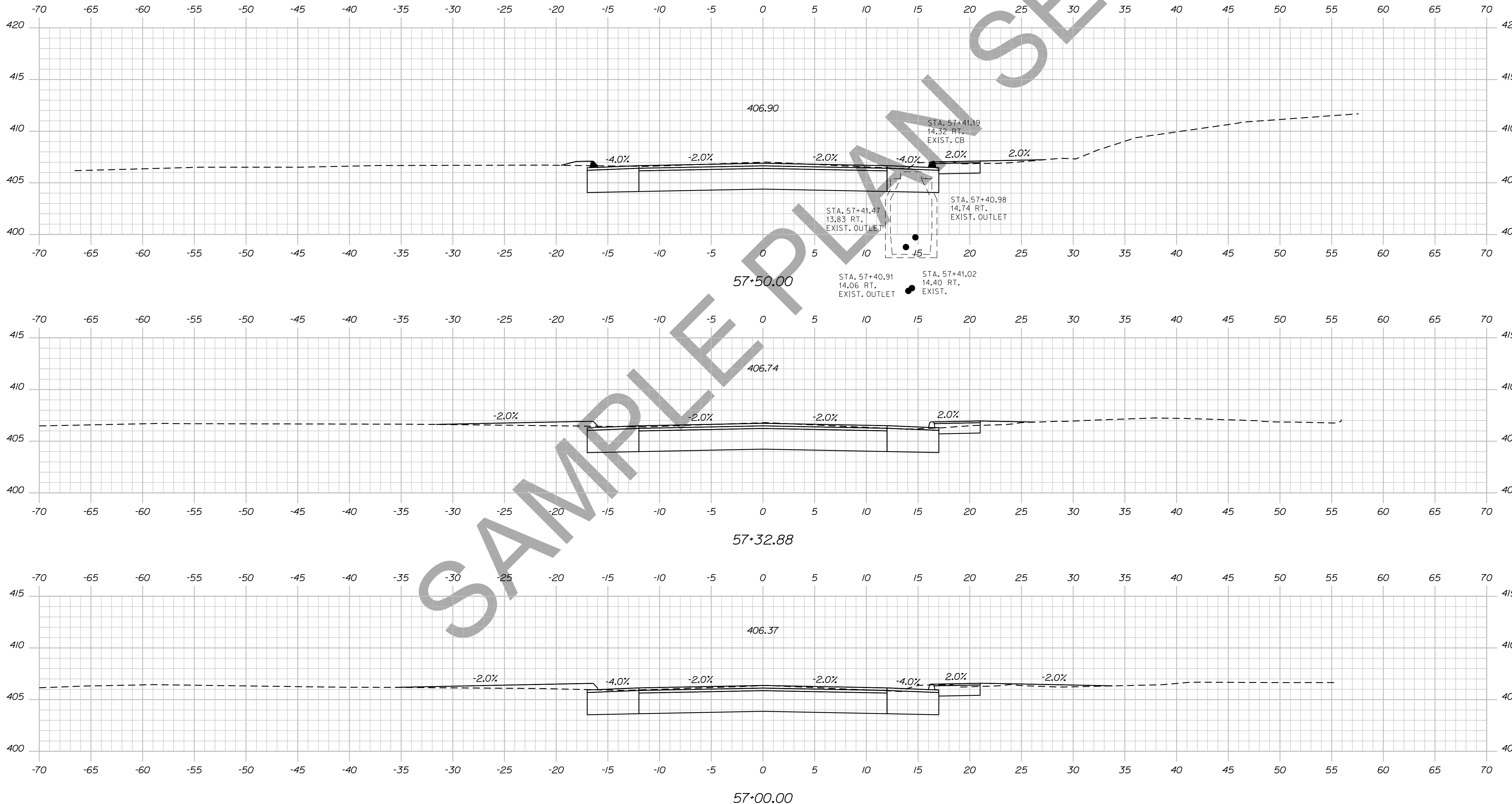

STATE OF MAINE
DEPARTMENT OF TRANSPORTATION
018246-00
WIN PIN 18246.00
HIGHWAY PLANS

PROJ. MANAGER	DESIGN-DETAILED	CHECKED-REVIEWED	DESIGNS-DET-MAILED	REVISIONS 1	REVISIONS 2	REVISIONS 3	REVISIONS 4	FIELD-CHANGES
\$projman\$	\$designer\$	\$checked\$	\$designed\$	\$rev1\$	\$rev2\$	\$rev3\$	\$rev4\$	\$field\$
\$signature1\$	\$signature2\$	\$signature3\$	\$signature4\$	\$signature5\$	\$signature6\$	\$signature7\$	\$signature8\$	\$signature9\$
DATE	BY	DATE	BY	DATE	BY	DATE	BY	DATE
\$date1\$	\$date2\$	\$date3\$	\$date4\$	\$date5\$	\$date6\$	\$date7\$	\$date8\$	\$date9\$
SIGNATURE	P.E. NUMBER	DATE	DATE	DATE	DATE	DATE	DATE	DATE
\$signature\$	\$pe\$	\$date\$	\$date\$	\$date\$	\$date\$	\$date\$	\$date\$	\$date\$

DEXTER
ROUTE 7
CROSS SECTIONS

SHEET NUMBER
82
OF 15

Sta. 57+00.00 to Sta. 57+50.00

Date: 12/10/2013

Username: atlee.mousseau

Division: HIGHWAY

Filename: ... \083_xsect_58+00_059.dgn

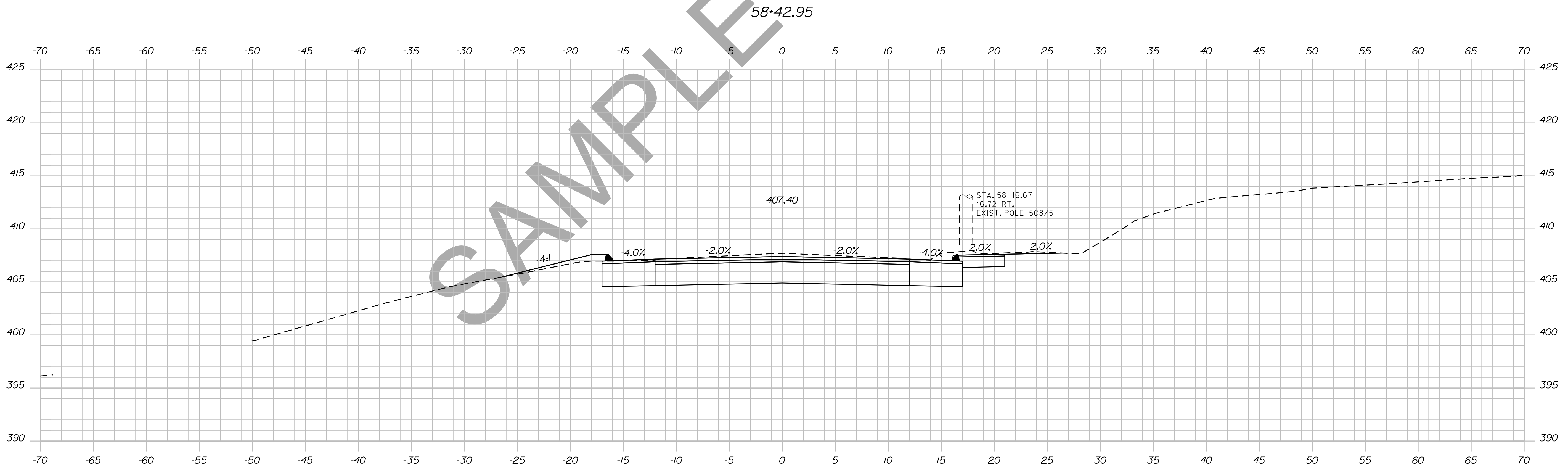
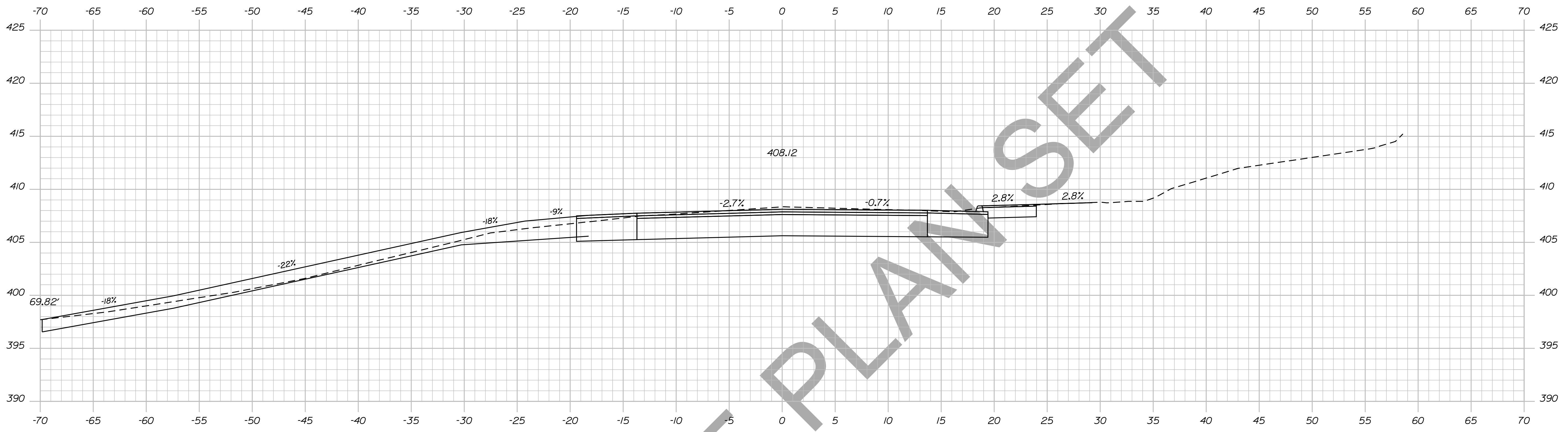

STATE OF MAINE
DEPARTMENT OF TRANSPORTATION
018246.00
WIN
PIN 18246.00
HIGHWAY PLANS

PROJ. MANAGER	BY	DATE	SIGNATURE
DESIGN DETAILED	DESIGNER 1	DATE 1	
CHECKED-REVIEWED	DESIGNER 2	DATE 2	
DESIGNS DETAILED	DESIGNER 3	DATE 3	
DESIGNS DETAILED	DESIGNER 4	DATE 4	
REVISIONS 1			
REVISIONS 2			
REVISIONS 3			
REVISIONS 4			
FIELD CHANGES			

DEXTER
ROUTE 7
CROSS SECTIONS

SHEET NUMBER
83
OF 15

Username: atlee.mousseau Date: 12/10/2013

Division: HIGHWAY

Filename: ... \084_xsect_58-50_060.dgn

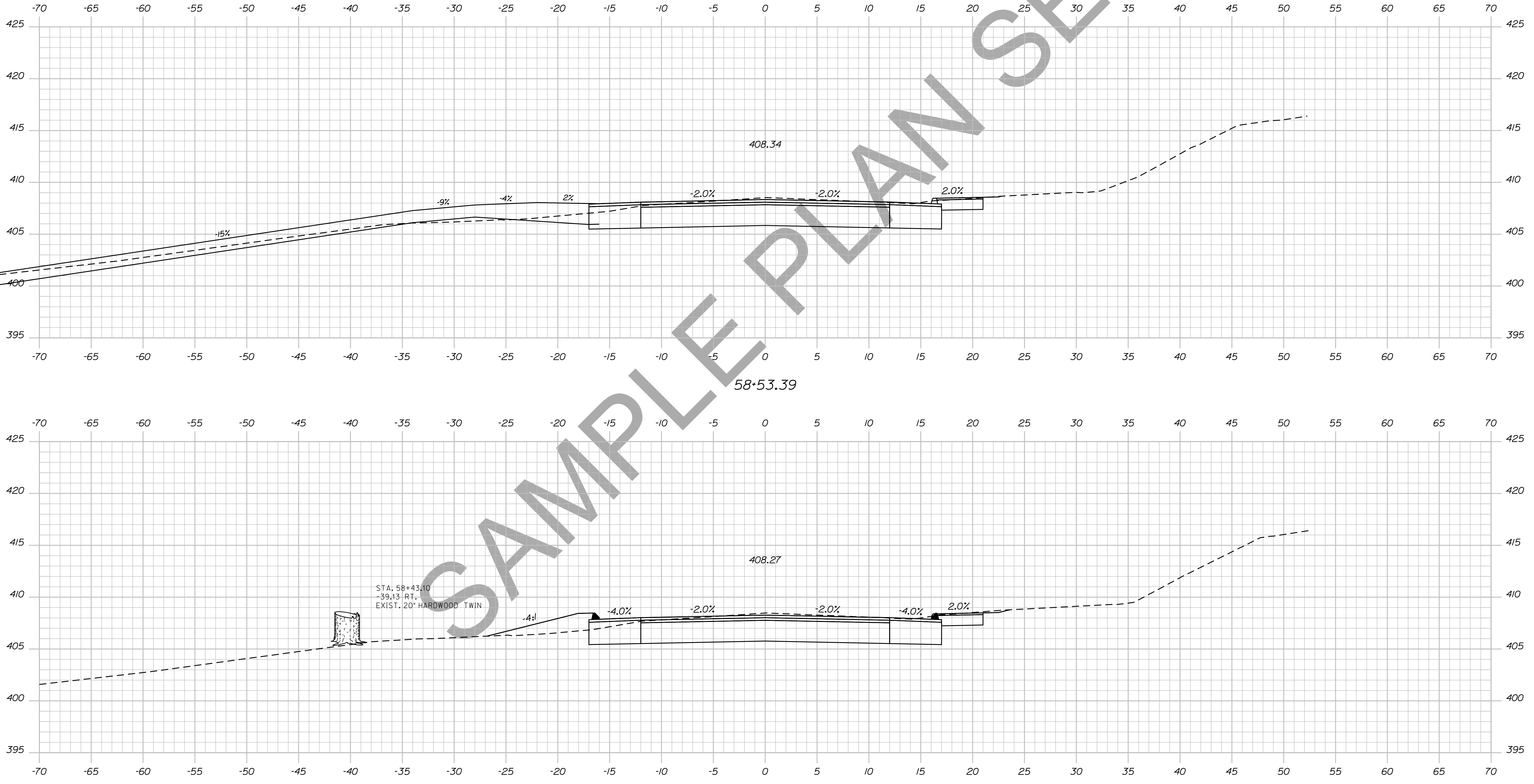

STA: 58+43.10
 -39.13 RT.
 EXIST. 20" HARDWOOD TWIN

STATE OF MAINE
 DEPARTMENT OF TRANSPORTATION
 018246.00
 WIN
 PIN 18246.00
 HIGHWAY PLANS

PROJ. MANAGER	DESIGN DETAILED	CHECKED-REVIEWED	DESIGN DETAILED	DESIGN DETAILED	REVISIONS 1	REVISIONS 2	REVISIONS 3	REVISIONS 4	FIELD CHANGES

BY	DATE	SIGNATURE

P.E. NUMBER	DATE

DEXTER
 ROUTE 7
 CROSS SECTIONS

SHEET NUMBER
 84
 OF 15

Date: 12/10/2013

Username: atlee.mousseau

Division: HIGHWAY

Filename: ... \085_xsect_59-00_061.dgn

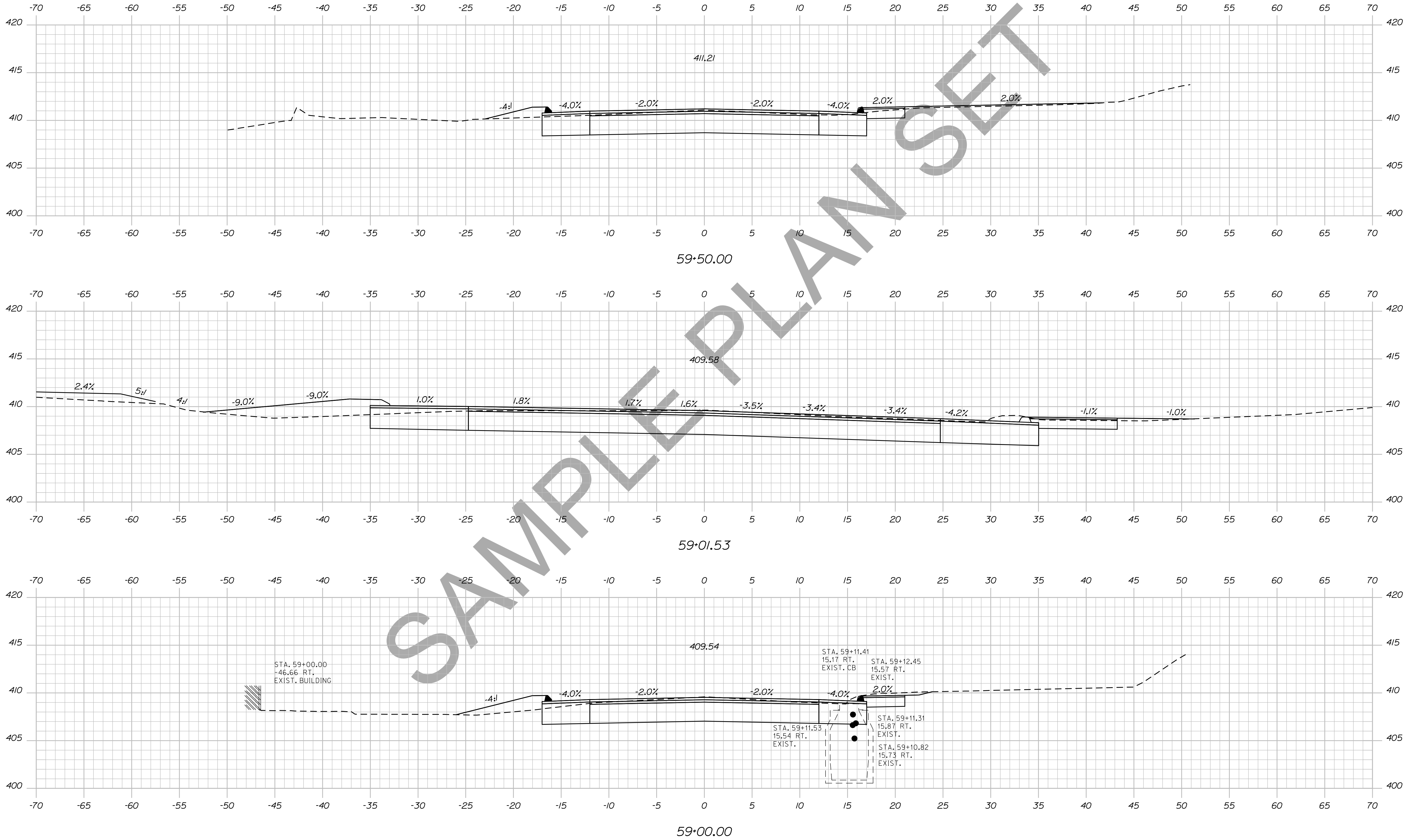

STATE OF MAINE

DEPARTMENT OF TRANSPORTATION

018246.00

WIN

PIN 18246.00

HIGHWAY PLANS

SIGNATURE

P.E. NUMBER

DATE

DATE

BY

PROJ. MANAGER

DESIGN-DETAILED

CHECKED-REVIEWED

DESIGN-DETAILED

DESIGN-DETAILED

REVISIONS 1

REVISIONS 2

REVISIONS 3

REVISIONS 4

FIELD CHANGES

FIELD CHANGES

FIELD CHANGES

FIELD CHANGES

FIELD CHANGES

FIELD CHANGES

FIELD CHANGES

FIELD CHANGES

FIELD CHANGES

FIELD CHANGES

FIELD CHANGES

FIELD CHANGES

FIELD CHANGES

DEXTER
ROUTE 7
CROSS SECTIONS

SHEET NUMBER

85

OF 15

Sta. 59+00.00 to Sta. 59+50.00

Filename: ... \086_xsect_59+53_062.dgn

Division: HIGHWAY

Username: atlee,mousseau

Date: 12/10/2013

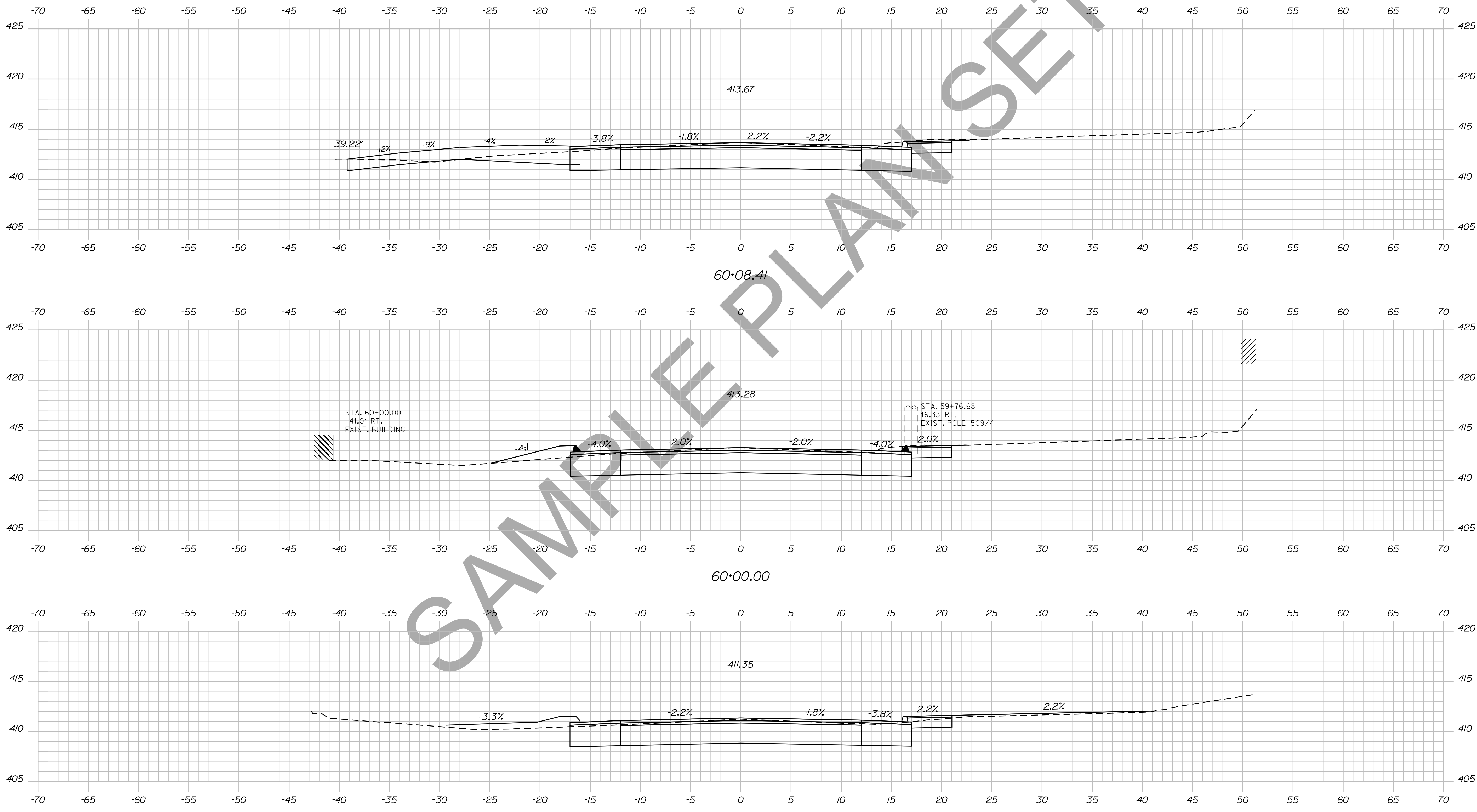

STATE OF MAINE
DEPARTMENT OF TRANSPORTATION
018246.00
WIN
PIN 18246.00
HIGHWAY PLANS

PROJ. MANAGER	BY	DATE	SIGNATURE
DESIGN-DETAILED	DESIGNER	DATE	SIGNATURE
CHECKED-REVIEWED	CHECKER	DATE	SIGNATURE
DESIGN-DETAILED	DESIGNER	DATE	SIGNATURE
DESIGN-DETAILED	DESIGNER	DATE	SIGNATURE
REVISIONS 1	REVISOR	DATE	SIGNATURE
REVISIONS 2	REVISOR	DATE	SIGNATURE
REVISIONS 3	REVISOR	DATE	SIGNATURE
REVISIONS 4	REVISOR	DATE	SIGNATURE
FIELD CHANGES	FIELD	DATE	SIGNATURE

DEXTER
ROUTE 7
CROSS SECTIONS

SHEET NUMBER
86
OF 15

Date: 12/10/2013

Username: atlee.mousseau

Division: HIGHWAY

Filename: ... \087_xsect_60+50_063.dgn

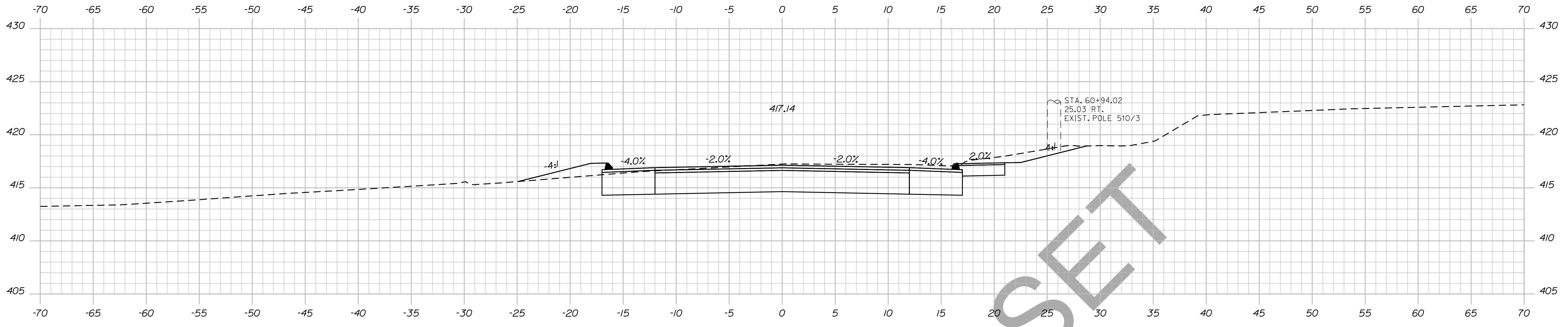

61+00.00

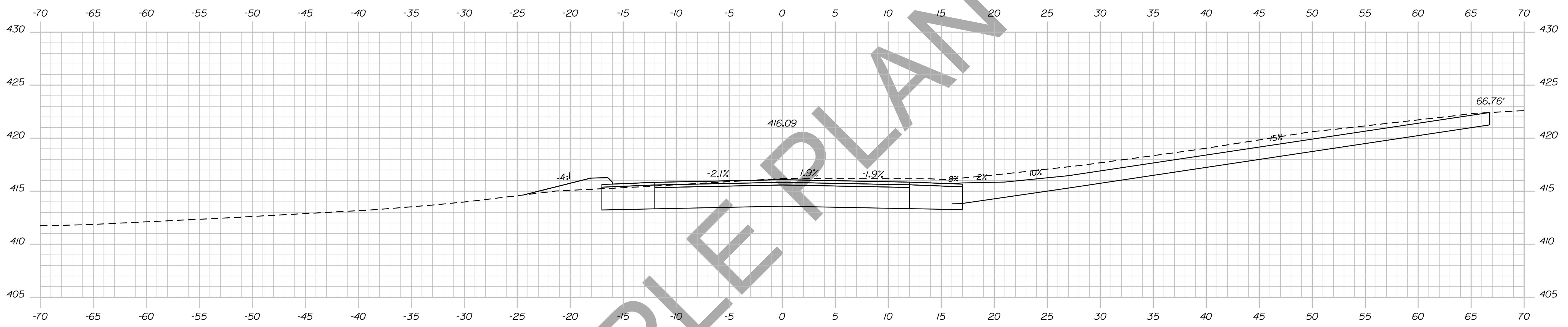

60+67.02

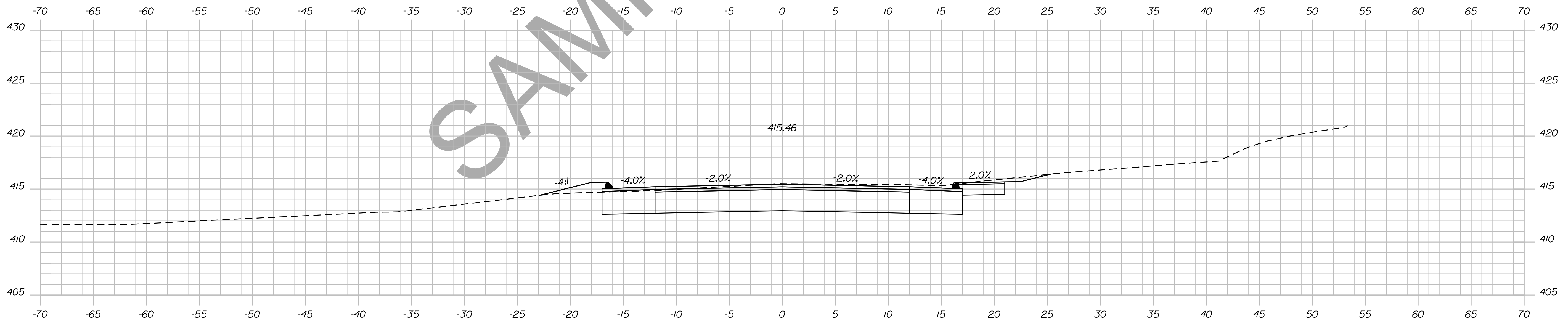

60+50.00

STATE OF MAINE
DEPARTMENT OF TRANSPORTATION

018246.00

WIN
PIN 18246.00

HIGHWAY PLANS

SIGNATURE

P.E. NUMBER

DATE

DATE

BY

PROJ. MANAGER

DESIGN-DETAILED

CHECKED-REVIEWED

DESIGN DET AILED

DESIGN DET AILED

REVISIONS 1

REVISIONS 2

REVISIONS 3

REVISIONS 4

FIELD CHANGES

DESIGNER

CHECKER

DESIGNER

DESIGNER

DESIGNER

DESIGNER

DESIGNER

DESIGNER

DESIGNER

DESIGNER

DESIGNER

DESIGNER

DESIGNER

DEXTER
ROUTE 7

CROSS SECTIONS

SHEET NUMBER

87

OF 15

Sta. 60+50.00 to Sta. 61+00.00

Date: 12/10/2013

Username: atlee.mousseau

Division: HIGHWAY

Filename: ... \088_xsect_61+12_064.dgn

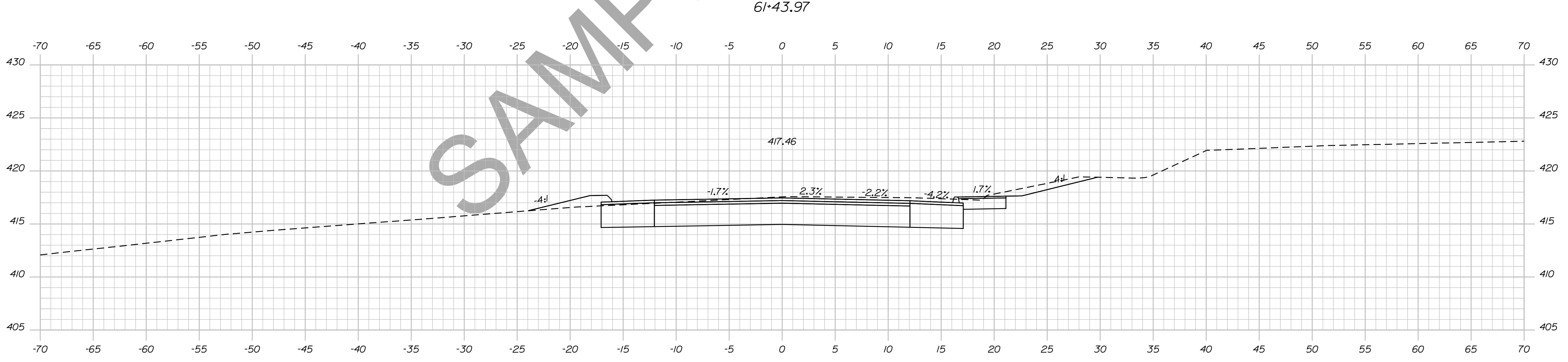
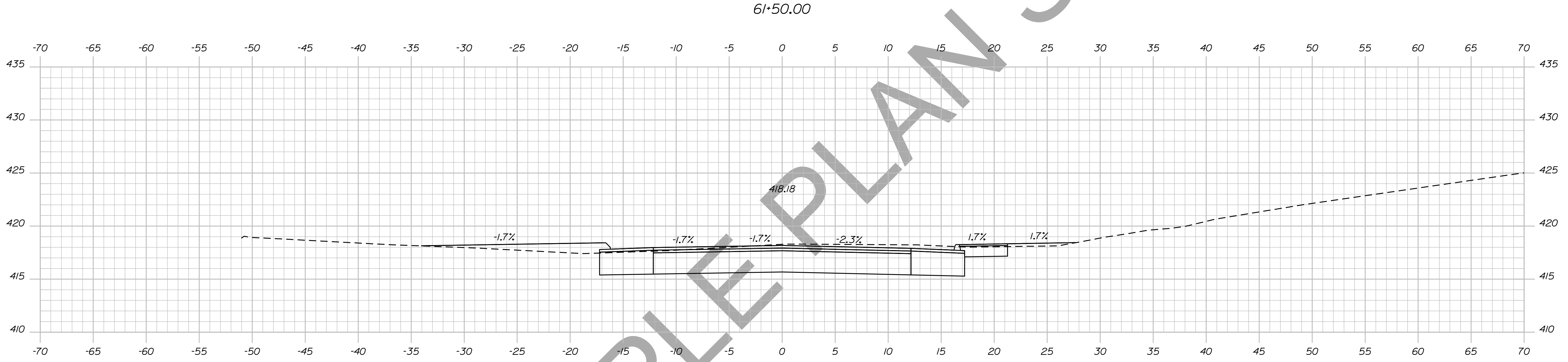
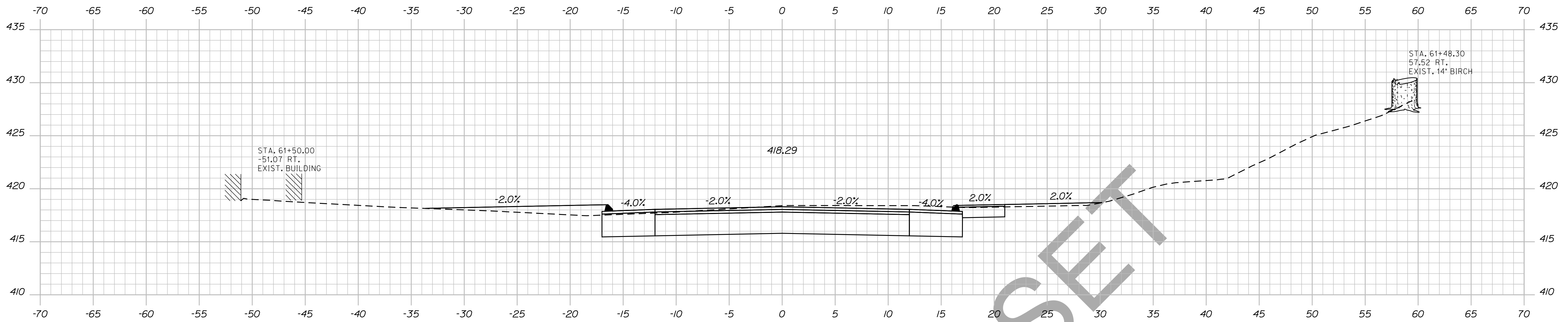

STATE OF MAINE
DEPARTMENT OF TRANSPORTATION
018246.00
WIN
PIN 18246.00
HIGHWAY PLANS

PROJ. MANAGER	BY	DATE	SIGNATURE
DESIGN-DETAILED	DESIGNER 1	PROJ DATE 1	
CHECKED-REVIEWED	DESIGNER 2	PROJ DATE 2	
DESIGNS DET AILED	DESIGNER 3	PROJ DATE 3	
DESIGNS DET AILED	DESIGNER 4	PROJ DATE 4	
REVISIONS 1		REVISION DATE 1	
REVISIONS 2		REVISION DATE 2	
REVISIONS 3		REVISION DATE 3	
REVISIONS 4		REVISION DATE 4	
FIELD CHANGES		FIELD DATE	

DEXTER
ROUTE 7
CROSS SECTIONS

SHEET NUMBER
88
OF 15

Date: 12/10/2013

Username: atlee.mousseau

Division: HIGHWAY

Filename: ... \089_xsect_61+88_065.dgn

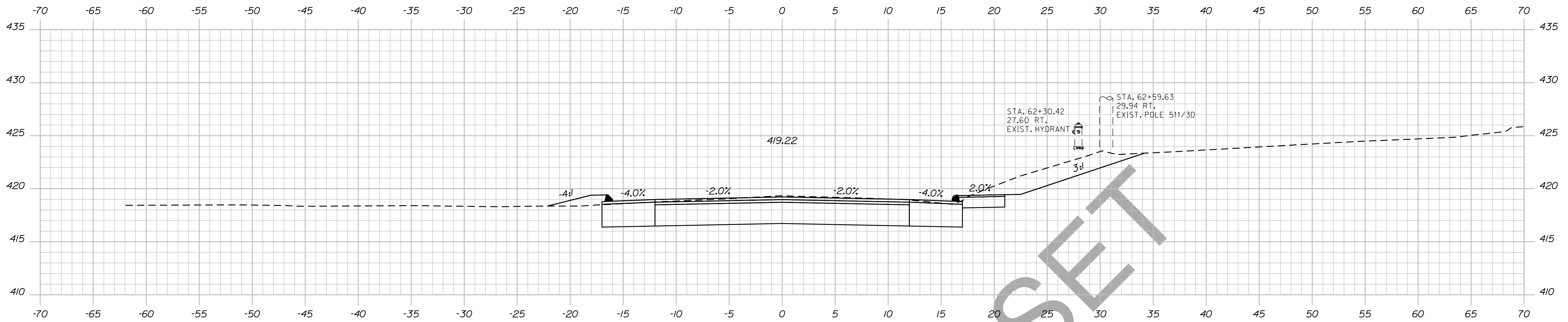

62+50.00

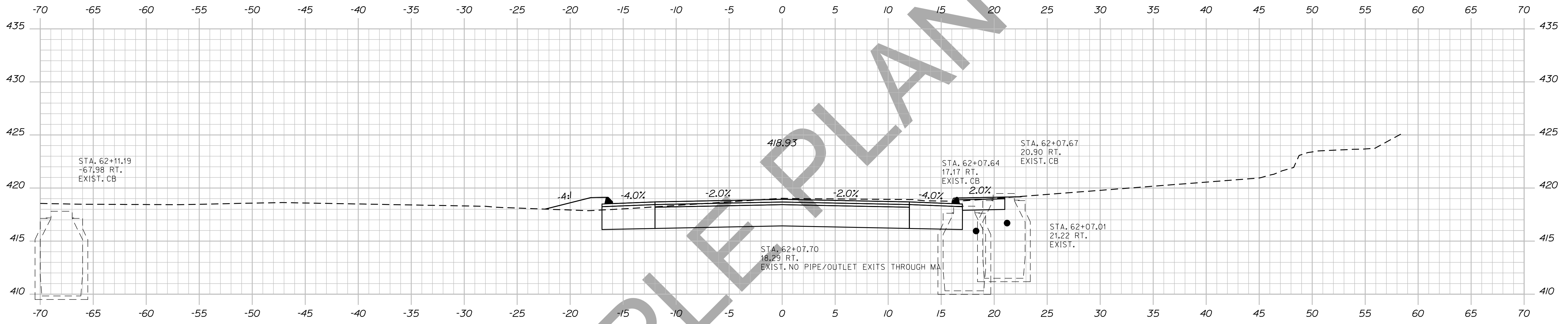

62+00.00

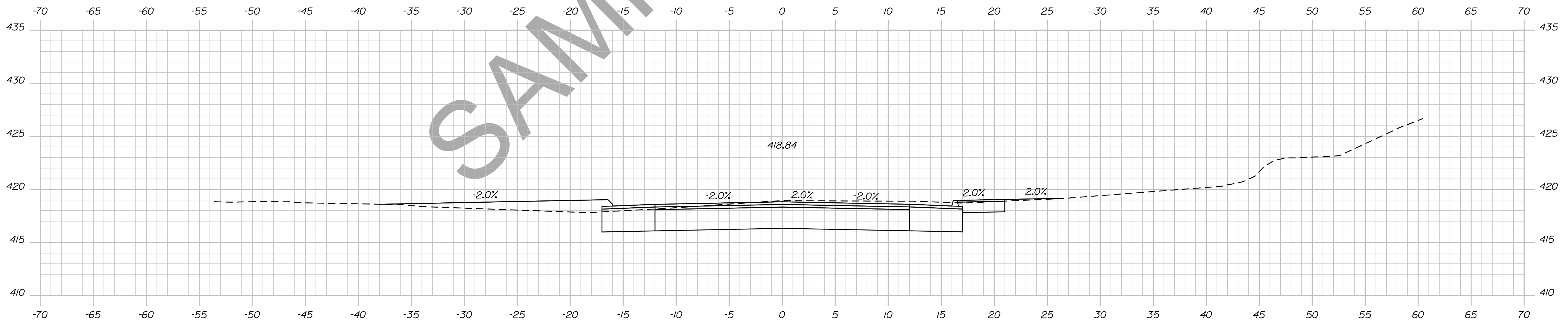

61+88.89

STATE OF MAINE
DEPARTMENT OF TRANSPORTATION

018246.00

WIN
PIN 18246.00

HIGHWAY PLANS

PROJ. MANAGER	BY	DATE	SIGNATURE
DESIGN DETAILER	DESIGNER	PROJ. DATE	
CHECKED/REVIEWED	DRAWER	PROJ. DATE	
DESIGN DETAILER	DESIGNER	PROJ. DATE	
DESIGN DETAILER	DESIGNER	PROJ. DATE	
REVISIONS 1			
REVISIONS 2			
REVISIONS 3			
REVISIONS 4			
FIELD CHANGES			

DEXTER
ROUTE 7
CROSS SECTIONS

SHEET NUMBER

89

OF 15

Date: 12/10/2013

Username: atlee.mousseau

Division: HIGHWAY

Filename: ... \090_xsect_62+59_066.dgn

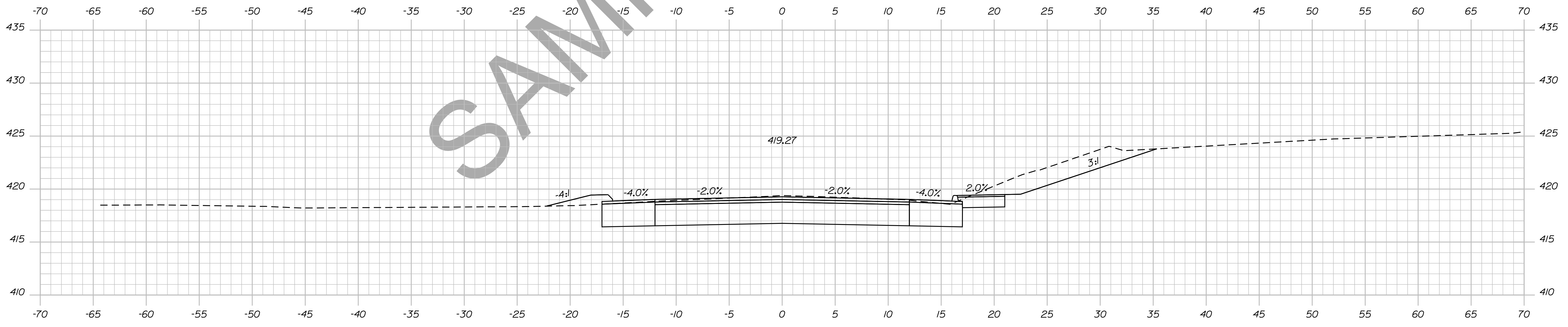
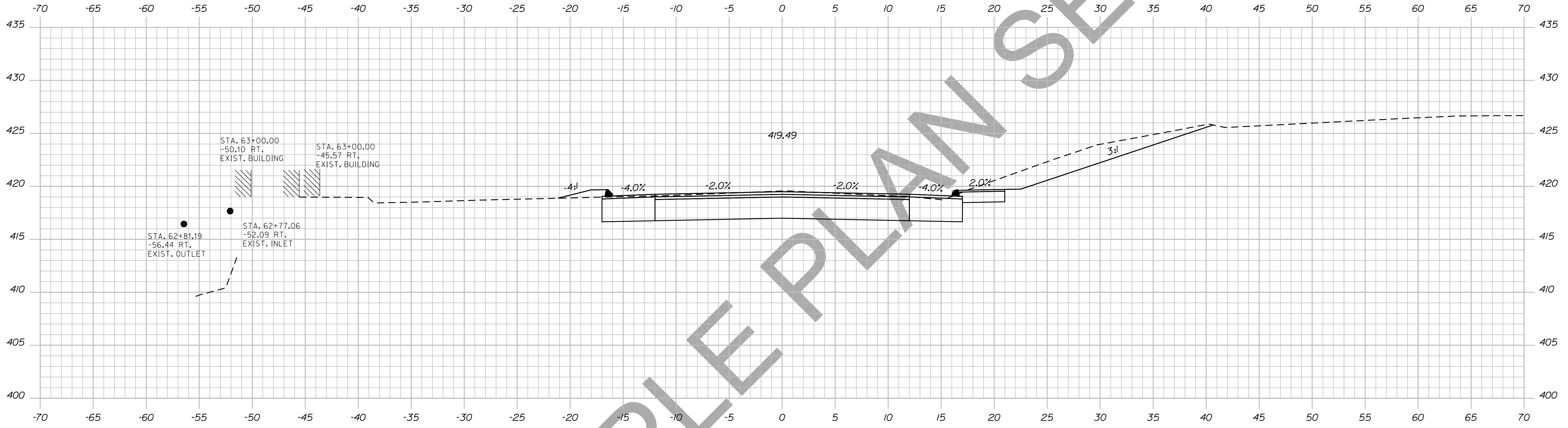

STATE OF MAINE
DEPARTMENT OF TRANSPORTATION
018246.00
WIN
PIN 18246.00
HIGHWAY PLANS

SIGNATURE
P.E. NUMBER
DATE

PROJ. MANAGER	DESIGN-DETAILED	CHECKED-REVIEWED	DESIGN-DETAILED	REVISIONS 1	REVISIONS 2	REVISIONS 3	REVISIONS 4	FIELD CHANGES

DEXTER
ROUTE 7
CROSS SECTIONS

SHEET NUMBER
90
OF 15

Date: 12/10/2013

Username: atlee.mousseau

Division: HIGHWAY

Filename: ... \091_Xsect_63+50_067.dgn

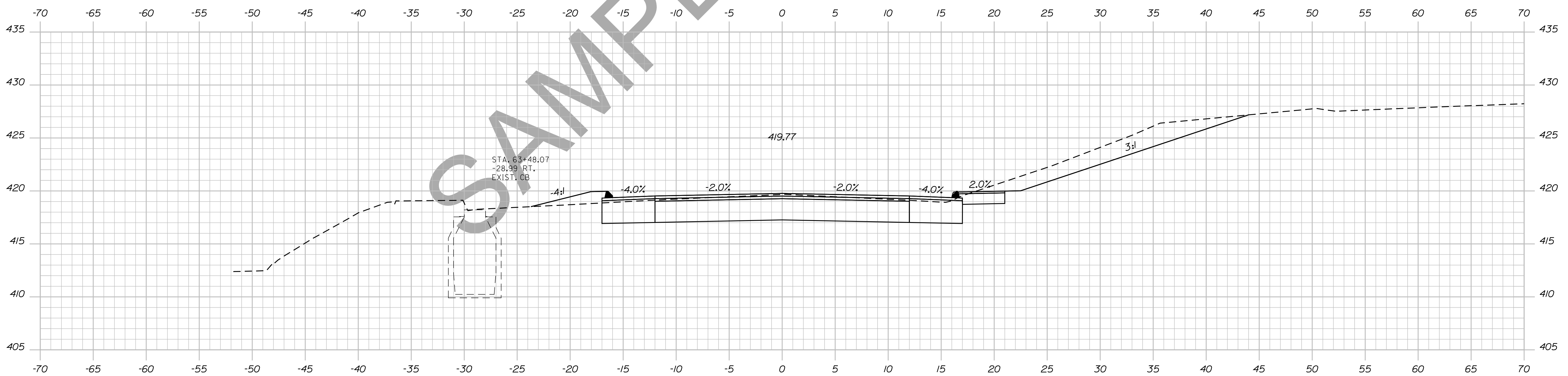
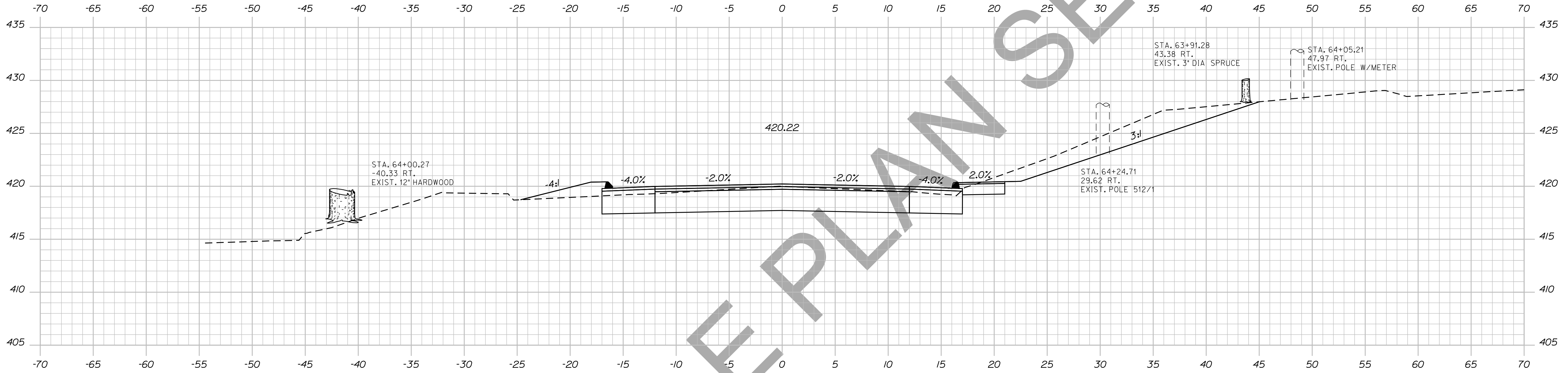

STATE OF MAINE
DEPARTMENT OF TRANSPORTATION
018246.00
WIN
PIN 18246.00
HIGHWAY PLANS

PROJ. MANAGER	DESIGN-DETAILED	CHECKED-REVIEWED	DESIGN-DETAILED	DESIGN-DETAILED	REVISIONS 1	REVISIONS 2	REVISIONS 3	REVISIONS 4	FIELD CHANGES

BY	DATE	SIGNATURE

P.E. NUMBER	DATE

DEXTER
ROUTE 7
CROSS SECTIONS

SHEET NUMBER
91
OF 15

Sta. 63+50.00 to Sta. 64+00.00

Username: atlee,mousseau Date:12/10/2013

Division: HIGHWAY

Filename: ... \092_xsect_64+50_068.dgn

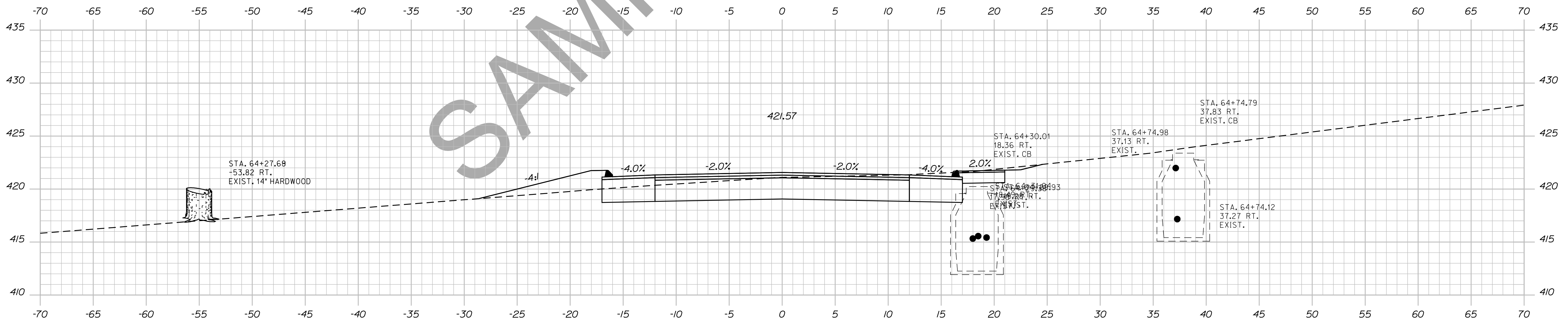
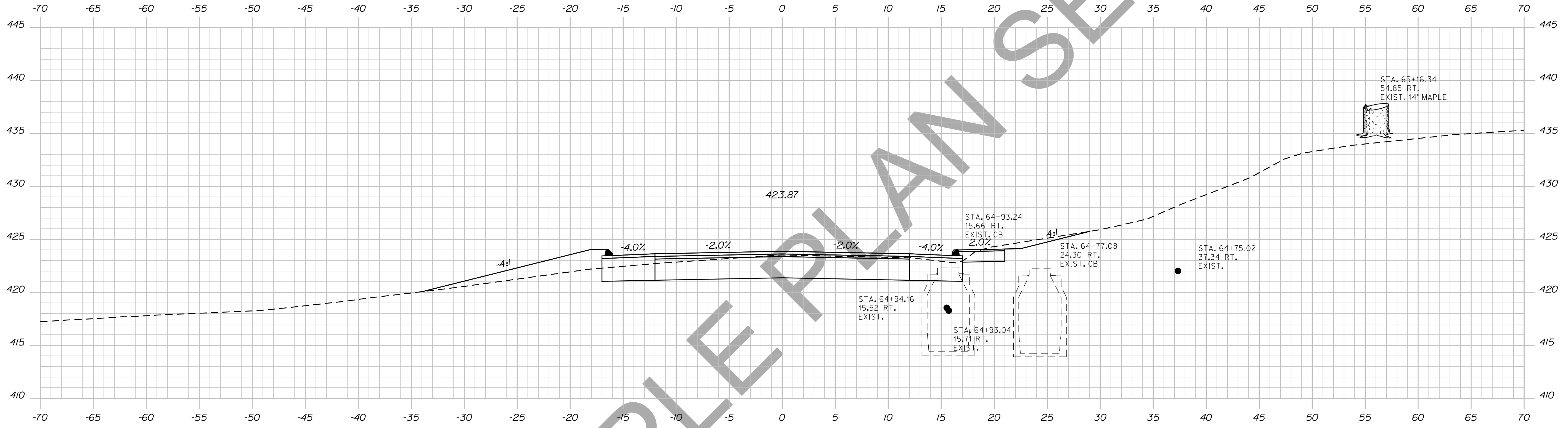

STATE OF MAINE
DEPARTMENT OF TRANSPORTATION
018246.00
WIN
PIN 18246.00
HIGHWAY PLANS

PROJ. MANAGER	DESIGN-DETAILED	CHECKED-REVIEWED	DESIGN-DETAILED	DESIGN-DETAILED	REVISIONS 1	REVISIONS 2	REVISIONS 3	REVISIONS 4	FIELD CHANGES	BY	DATE	SIGNATURE	P.E. NUMBER	DATE

DEXTER
ROUTE 7
CROSS SECTIONS

SHEET NUMBER
92
OF 15

Date: 12/10/2013

Username: atlee.mousseau

Division: HIGHWAY

Filename: ... \093_xsect_65+50_069.dgn

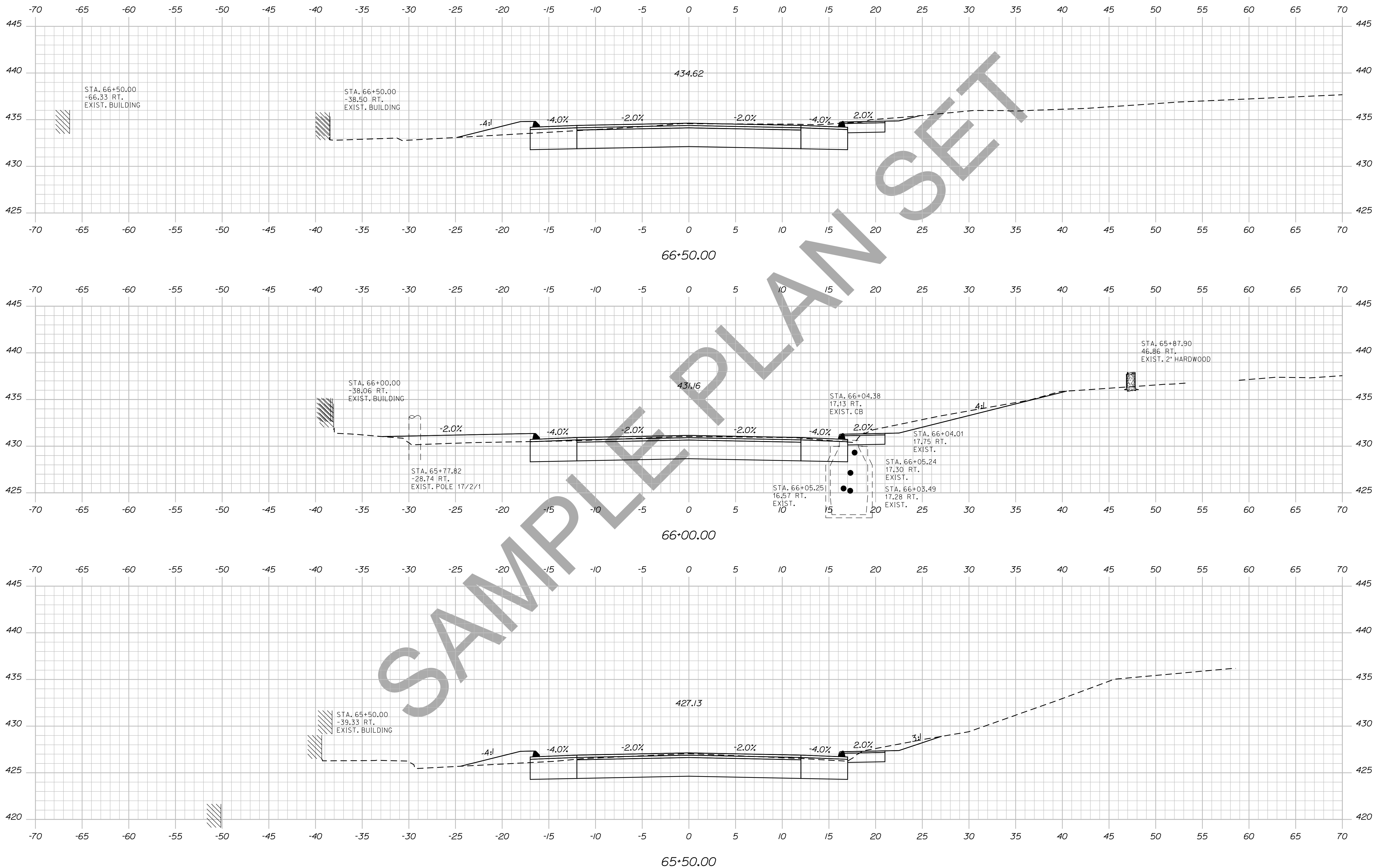

STATE OF MAINE
DEPARTMENT OF TRANSPORTATION
018246.00
WIN
PIN 18246.00
HIGHWAY PLANS

PROJ. MANAGER	BY	DATE	SIGNATURE	P.E. NUMBER	DATE
DESIGN DETAILED	DESIGNER	DATE			
CHECKED/REVIEWED	CHECKER	DATE			
DESIGN DETAILED	DESIGNER	DATE			
REVISIONS 1	DESIGNER	DATE			
REVISIONS 2	DESIGNER	DATE			
REVISIONS 3	DESIGNER	DATE			
REVISIONS 4	DESIGNER	DATE			
FIELD CHANGES	DESIGNER	DATE			

DEXTER
ROUTE 7
CROSS SECTIONS

SHEET NUMBER
93
OF 15

Date: 12/10/2013

Username: atlee.mousseau

Division: HIGHWAY

Filename: ... \094_xsect_67-00_070.dgn

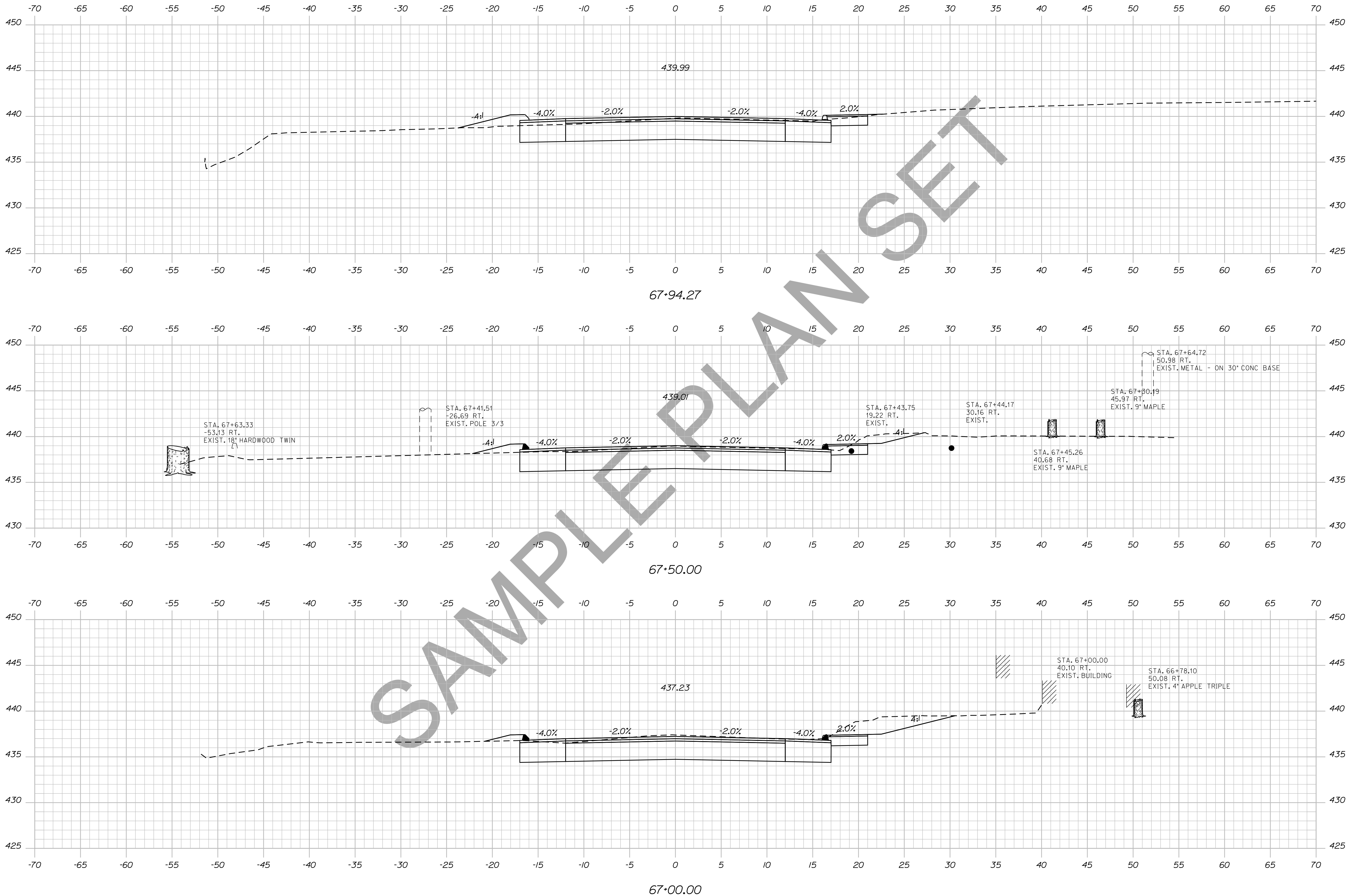

STATE OF MAINE
DEPARTMENT OF TRANSPORTATION
018246.00
WIN
PIN 18246.00
HIGHWAY PLANS

PROJ. MANAGER	BY	DATE	SIGNATURE	P.E. NUMBER	DATE
DESIGN-DETAILED	DESIGNER	DATE			
CHECKED-REVIEWED	CHECKER	DATE			
DESIGN-DETAILED	DESIGNER	DATE			
REVISIONS 1					
REVISIONS 2					
REVISIONS 3					
REVISIONS 4					
FIELD CHANGES					

DEXTER
ROUTE 7
CROSS SECTIONS

SHEET NUMBER
94
OF 15

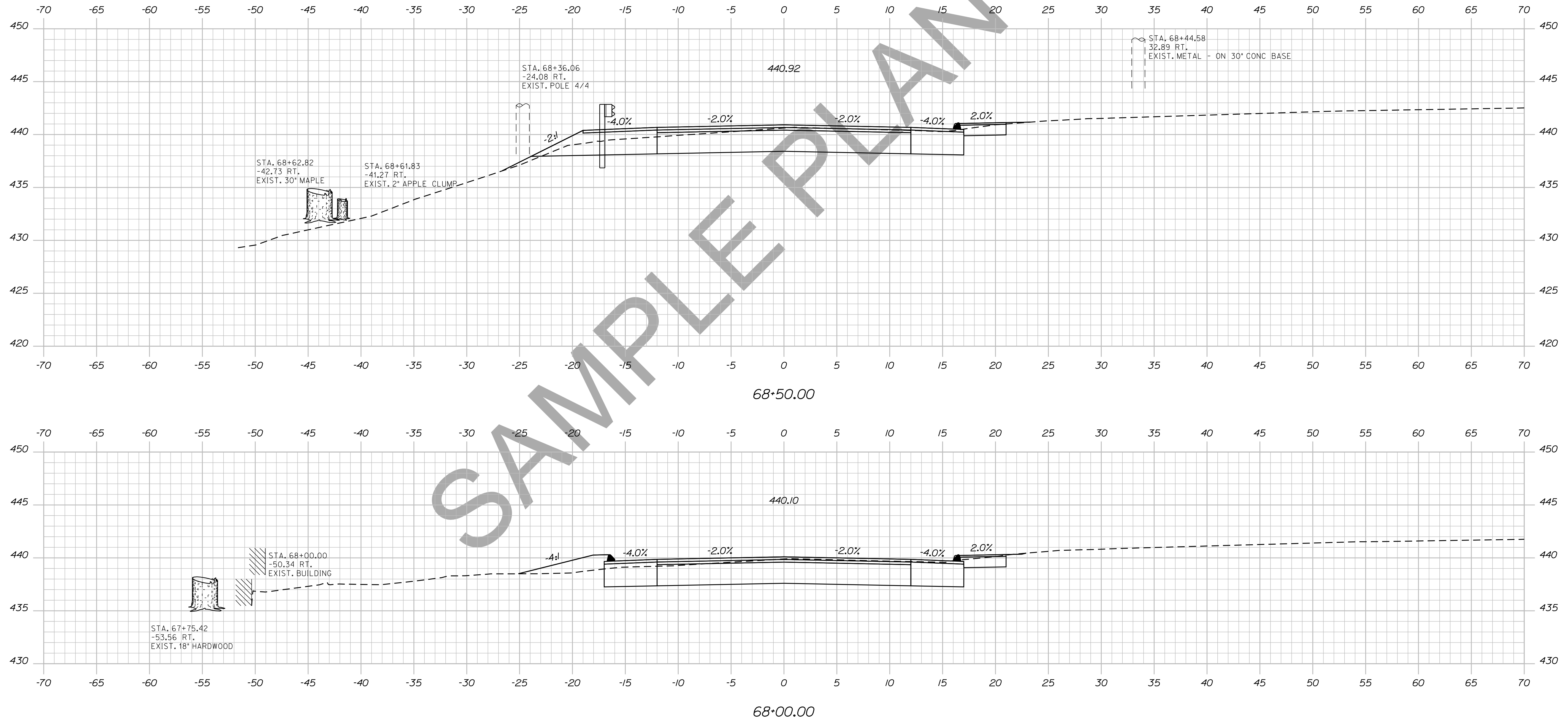

SAMPLE PLAN SET

PROJ. MANAGER	DESIGN DETAILED	CHECKED	DESIGN DET AILED	DESIGN DET AILED	REVISIONS 1	REVISIONS 2	REVISIONS 3	REVISIONS 4	FIELD CHANGES	DATE	BY	DATE	SIGNATURE

DEXTER
ROUTE 7
CROSS SECTIONS

Date: 12/10/2013

Username: atlee.mousseau

Division: HIGHWAY

Filename: ... \096_Xsect_68+57_072.dgn

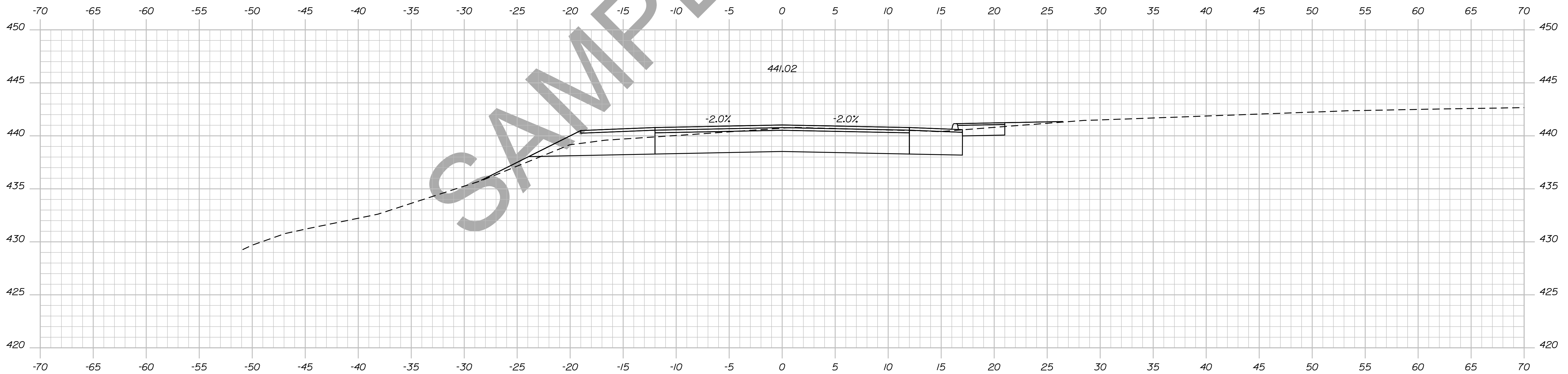
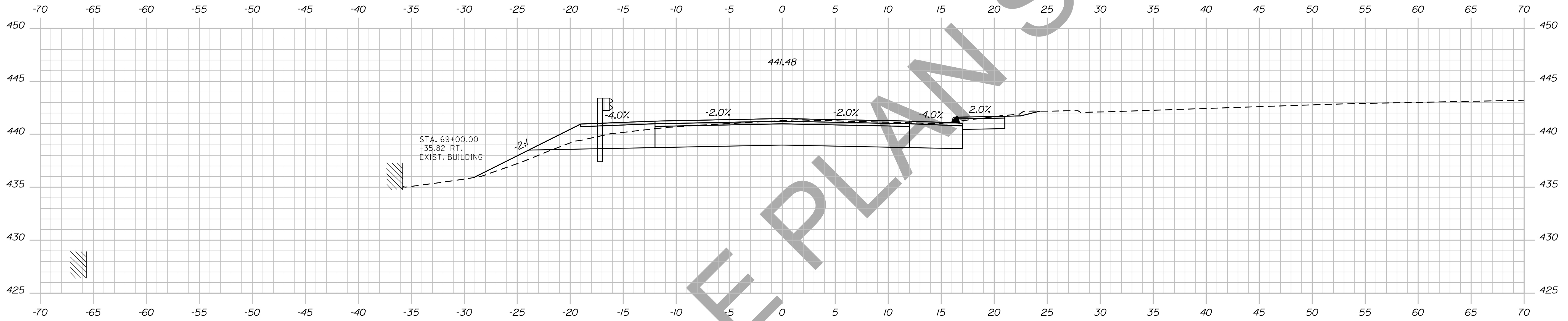

SAMPLE PLAN SET

STATE OF MAINE
DEPARTMENT OF TRANSPORTATION
018246.00
WIN
PIN 18246.00
HIGHWAY PLANS

PROJ. MANAGER	BY	DATE	SIGNATURE
DESIGN DETAILED	DESIGNER	DATE	
CHECKED-REVIEWED	CHECKER	DATE	
DESIGN DETAILED	DESIGNER	DATE	
DESIGN DETAILED	DESIGNER	DATE	
REVISIONS 1	REVISION	DATE	
REVISIONS 2	REVISION	DATE	
REVISIONS 3	REVISION	DATE	
REVISIONS 4	REVISION	DATE	
FIELD CHANGES	FIELD	DATE	

DEXTER
ROUTE 7
CROSS SECTIONS

SHEET NUMBER
96
OF 15

Date: 12/10/2013

Username: atlee.mousseau

Division: HIGHWAY

Filename: ... \097_xsect_69+14_073.dgn

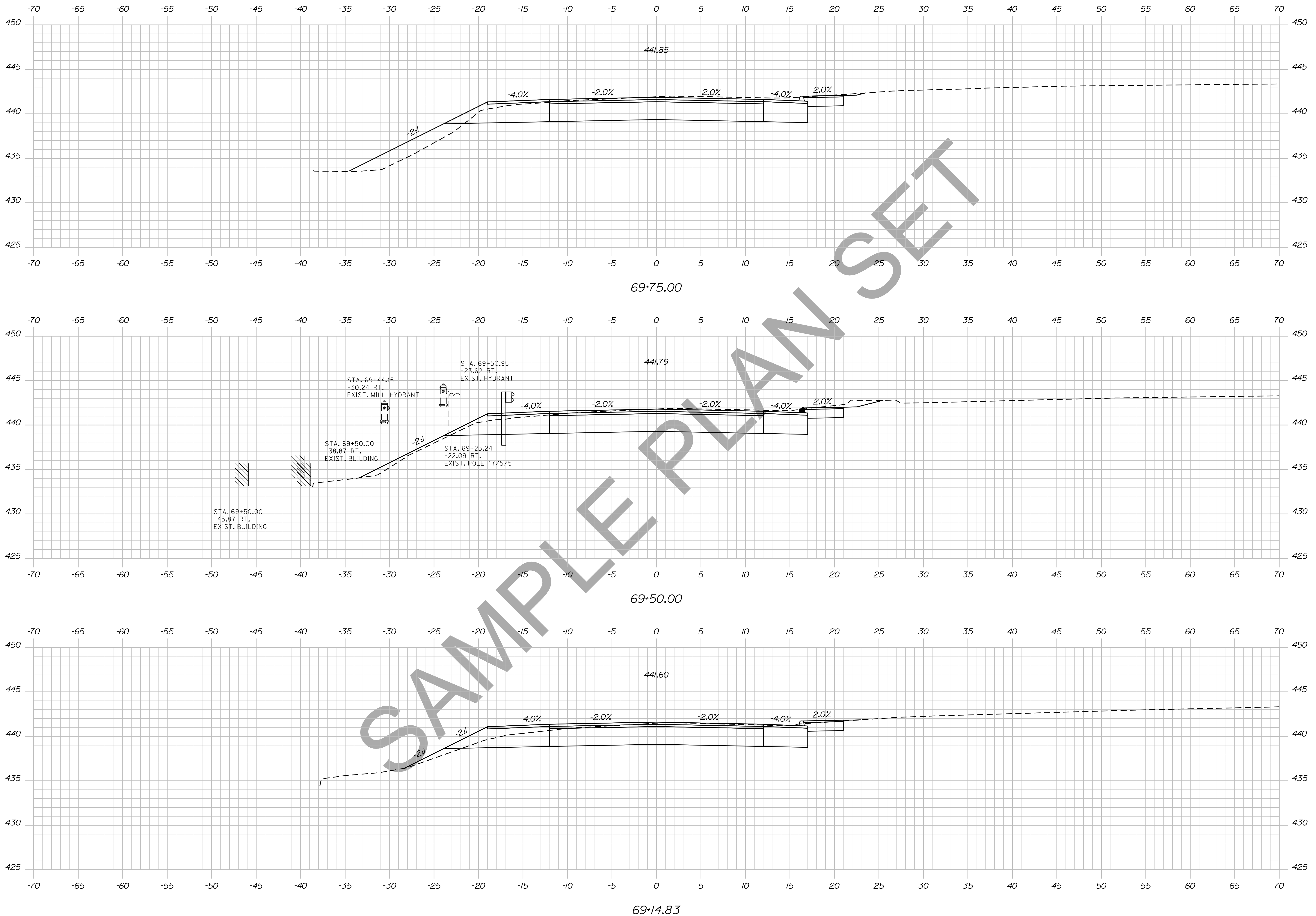

STATE OF MAINE
DEPARTMENT OF TRANSPORTATION
018246.00
WIN
PIN 18246.00
HIGHWAY PLANS

PROJ. MANAGER	BY	DATE	SIGNATURE
DESIGN DETAILED	DESIGNER	DATE	SIGNATURE
CHECKED-REVIEWED	CHECKER	DATE	SIGNATURE
DESIGN DET AILED	DESIGNER	DATE	SIGNATURE
DESIGN DET AILED	DESIGNER	DATE	SIGNATURE
REVISIONS 1	REVISOR	DATE	P.E. NUMBER
REVISIONS 2	REVISOR	DATE	DATE
REVISIONS 3	REVISOR	DATE	DATE
REVISIONS 4	REVISOR	DATE	DATE
FIELD CHANGES	FIELD	DATE	DATE

DEXTER
ROUTE 7
CROSS SECTIONS

SHEET NUMBER
97
OF 15

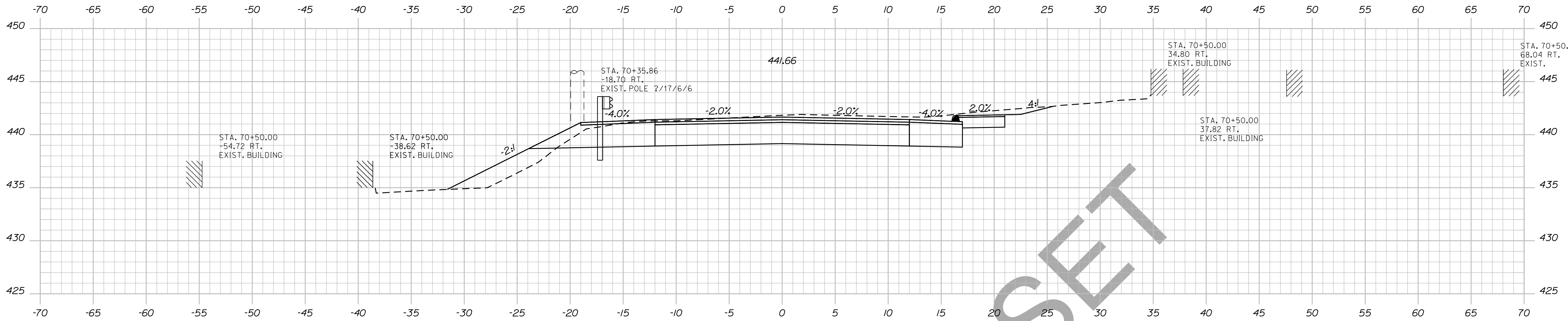

70+50.00

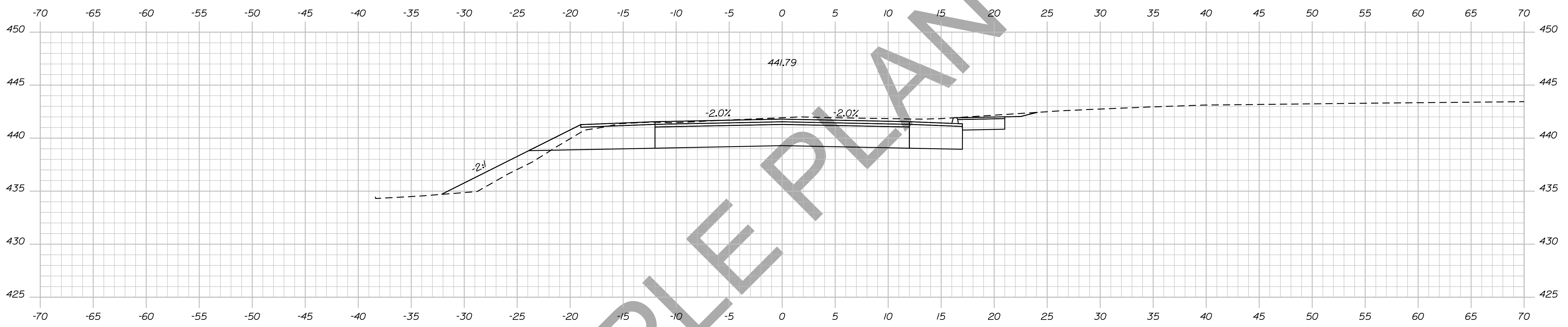

70+22.98

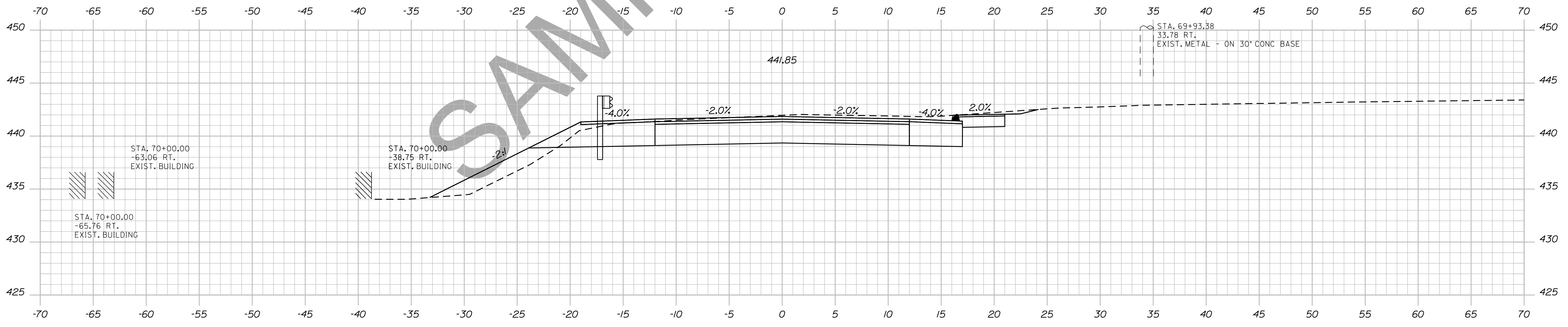

70+00.00

STATE OF MAINE
DEPARTMENT OF TRANSPORTATION
018246.00
WIN
PIN 18246.00
HIGHWAY PLANS

PROJ. MANAGER	DESIGNER	CHECKED	DATE	SIGNATURE

DEXTER
ROUTE 7
CROSS SECTIONS

SHEET NUMBER
98
OF 15

Date: 12/10/2013

Username: atlee.mousseau

Division: HIGHWAY

Filename: ... \099_xsect_71+00_075.dgn

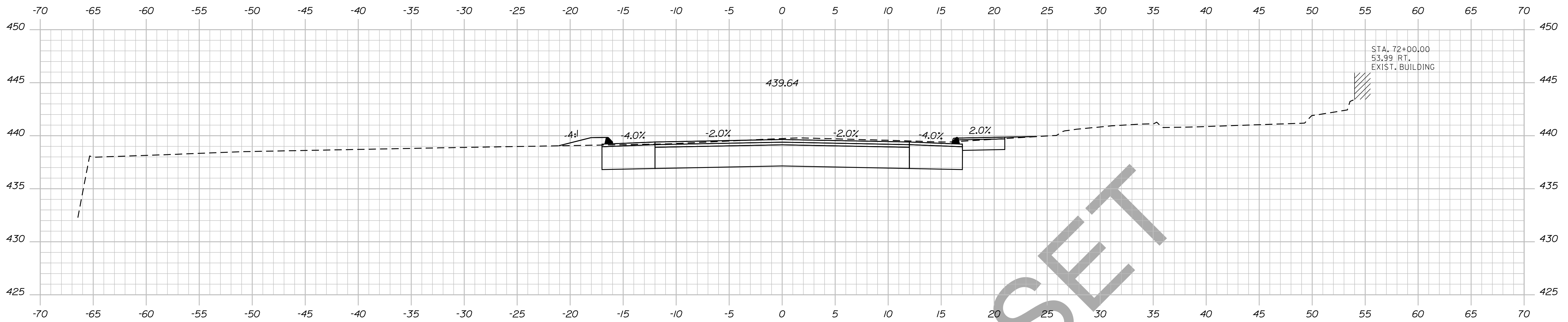

72+00.00



71+50.00

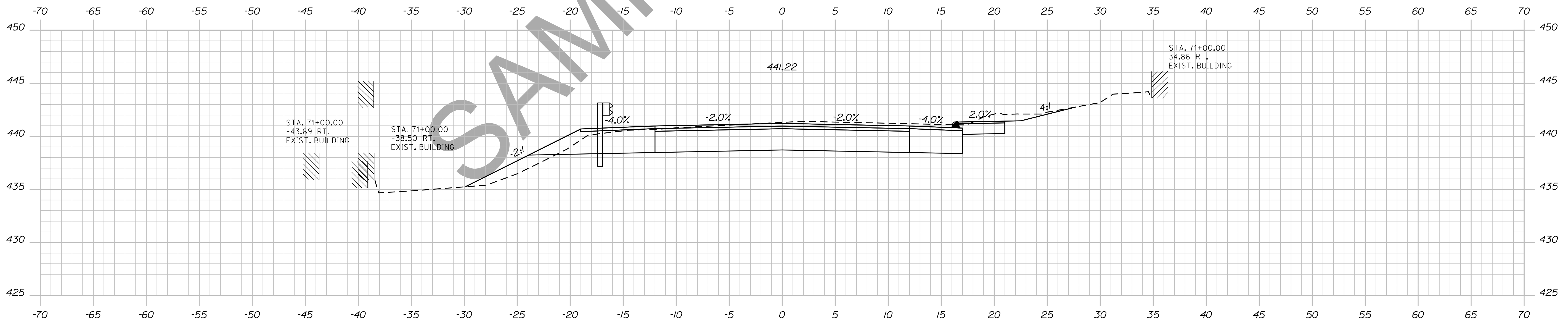

71+00.00

STATE OF MAINE
DEPARTMENT OF TRANSPORTATION

018246.00

WIN
PIN 18246.00
HIGHWAY PLANS

SIGNATURE

P.E. NUMBER

DATE

DATE

BY

PROJ. MANAGER

CHECKED-REVIEWED

DESIGN DETAILER

DESIGN DETAILER

REVISIONS 1

REVISIONS 2

REVISIONS 3

REVISIONS 4

FIELD CHANGES

DESIGNER

DESIGNER

DESIGNER

DESIGNER

DESIGNER

DESIGNER

DESIGNER

DEXTER
ROUTE 7

CROSS SECTIONS

SHEET NUMBER

99

OF 15

Sta. 71+00.00 to Sta. 72+00.00

Date: 12/10/2013

Username: atlee.mousseau

Division: HIGHWAY

Filename: ... \100_Xsect_72+23_076.dgn

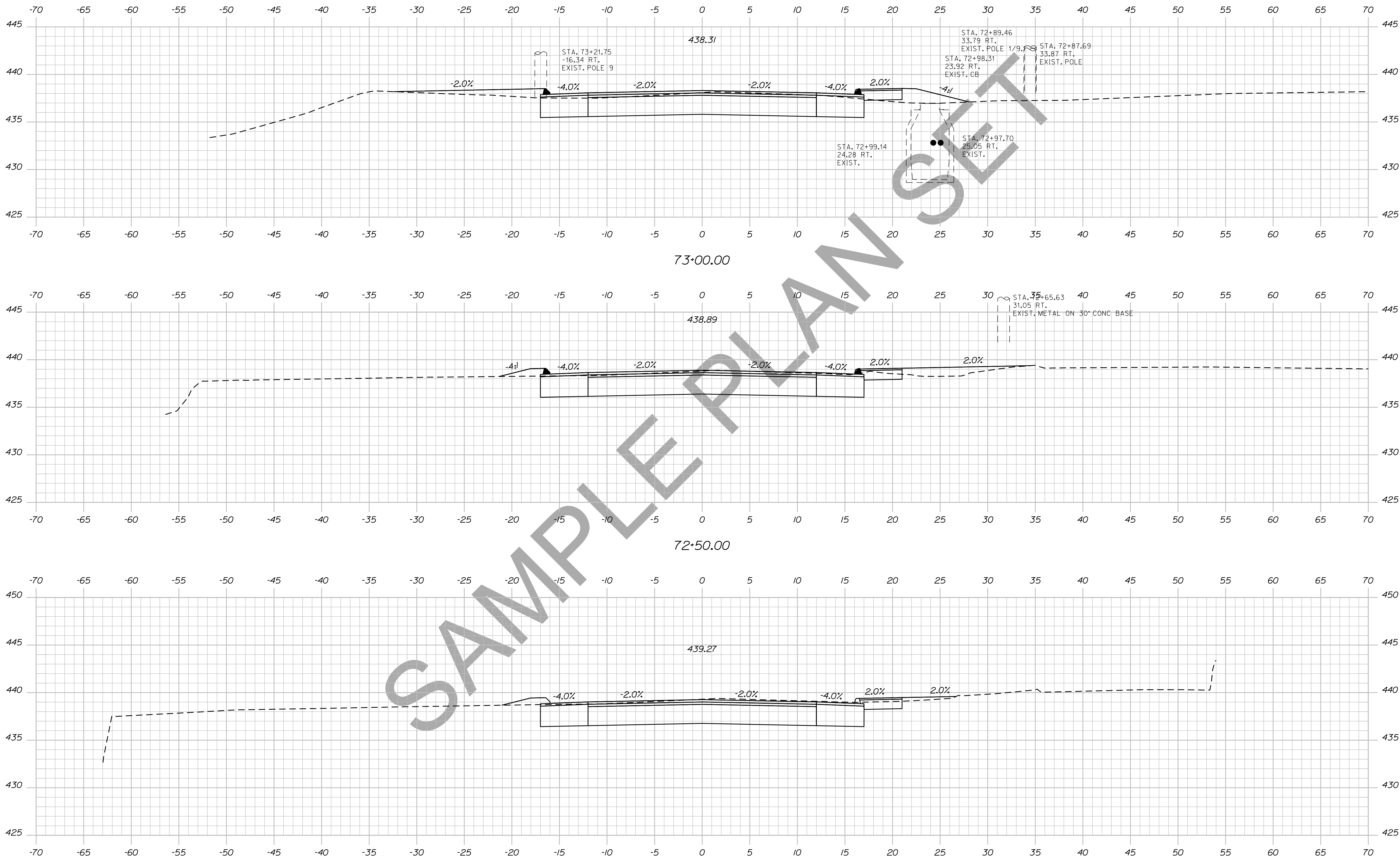

STATE OF MAINE
DEPARTMENT OF TRANSPORTATION
018246.00

WIN
PIN 18246.00
HIGHWAY PLANS

PROJ. MANAGER	DESIGN-DETAILED	CHECKED-REVIEWED	DESIGN-DETAILED	DESIGN-DETAILED	DESIGN-DETAILED	DESIGN-DETAILED	DESIGN-DETAILED	DESIGN-DETAILED	DESIGN-DETAILED	DATE

DEXTER
ROUTE 7
CROSS SECTIONS

SHEET NUMBER
100
OF 15

Filename: ... \101_Xsect_73+50_077.dgn

Division: HIGHWAY

Username: atlee,mousseau

Date: 12/10/2013

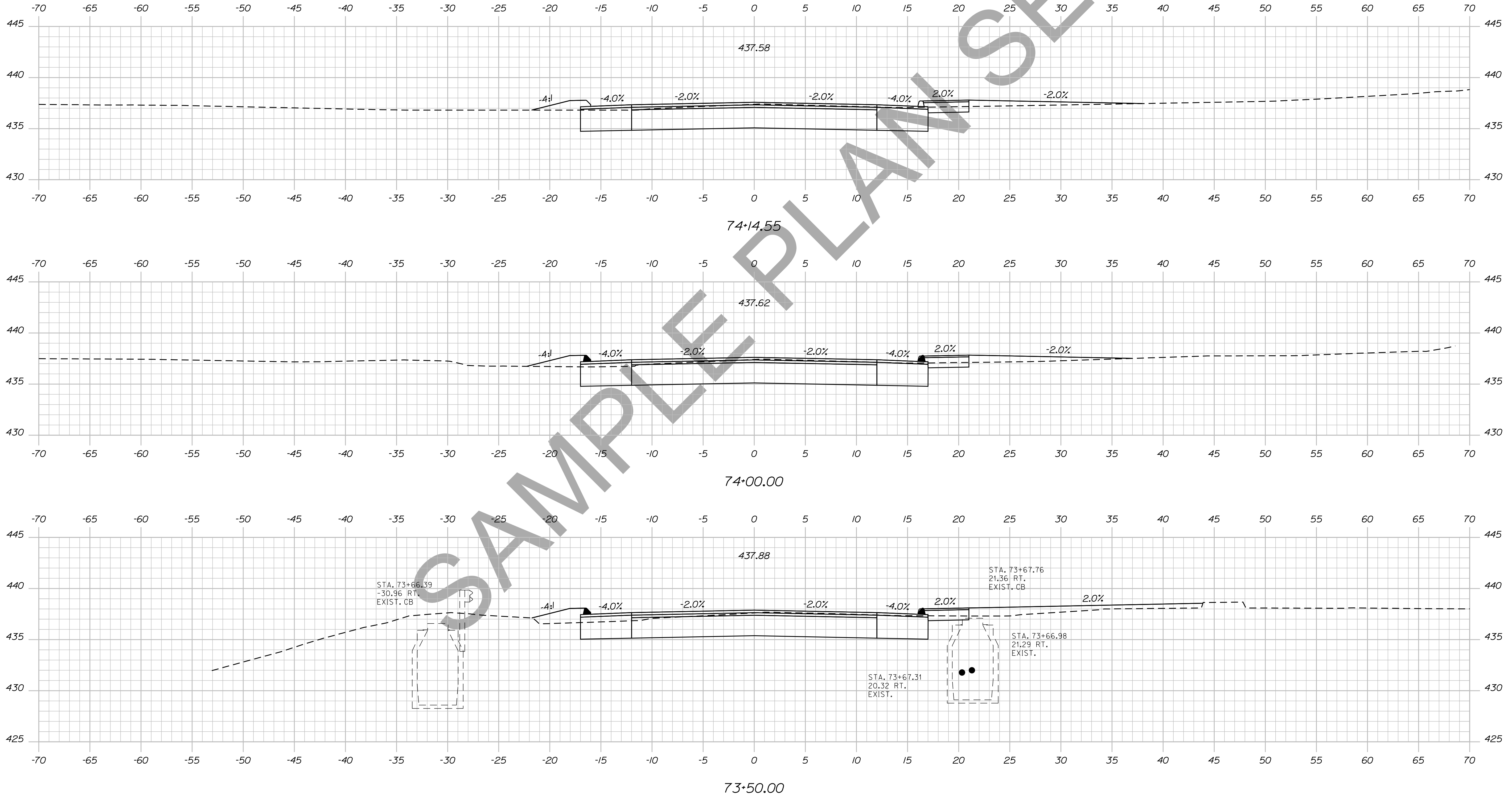

STATE OF MAINE
DEPARTMENT OF TRANSPORTATION
018246.00
WIN
PIN 18246.00
HIGHWAY PLANS

PROJ. MANAGER	BY	DATE	SIGNATURE
DESIGN-DETAILED	DESIGNER	DATE	SIGNATURE
CHECKED-REVIEWED	CHECKER	DATE	SIGNATURE
DESIGN-DETAILED	DESIGNER	DATE	SIGNATURE
DESIGN-DETAILED	DESIGNER	DATE	SIGNATURE
REVISIONS 1	REVISION	DATE	P.E. NUMBER
REVISIONS 2	REVISION	DATE	DATE
REVISIONS 3	REVISION	DATE	DATE
REVISIONS 4	REVISION	DATE	DATE
FIELD CHANGES	FIELD	DATE	DATE

DEXTER
ROUTE 7
CROSS SECTIONS

SHEET NUMBER
101
OF 15

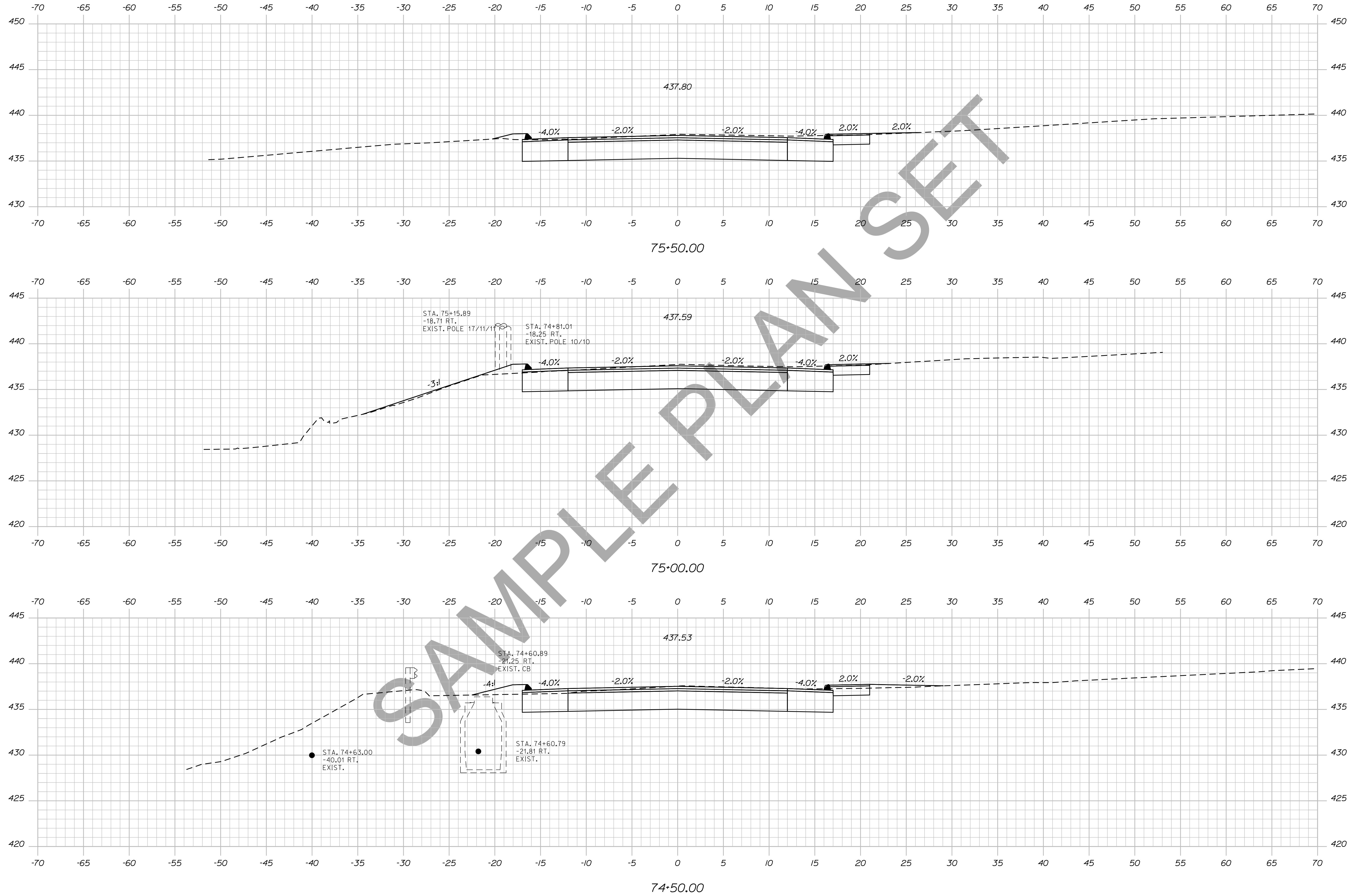

STATE OF MAINE
DEPARTMENT OF TRANSPORTATION
018246.00

PROJ. MANAGER	BY	DATE	SIGNATURE
DESIGN-DETAILED	DESIGNER	DATE	
CHECKED-REVIEWED	CHECKER	DATE	
DESIGN-DET. AILED	DESIGNER	DATE	
DESIGN-DET. AILED	DESIGNER	DATE	
REVISIONS 1	REVISOR	DATE	
REVISIONS 2	REVISOR	DATE	
REVISIONS 3	REVISOR	DATE	
REVISIONS 4	REVISOR	DATE	
FIELD CHANGES	FIELD CHANGES	DATE	

WIN
PIN 18246.00
HIGHWAY PLANS

DEXTER
ROUTE 7
CROSS SECTIONS

SHEET NUMBER
102
OF 15

Date: 12/10/2013

Username: atlee.mousseau

Division: HIGHWAY

Filename: ... \103_Xsect_76+00_079.dgn

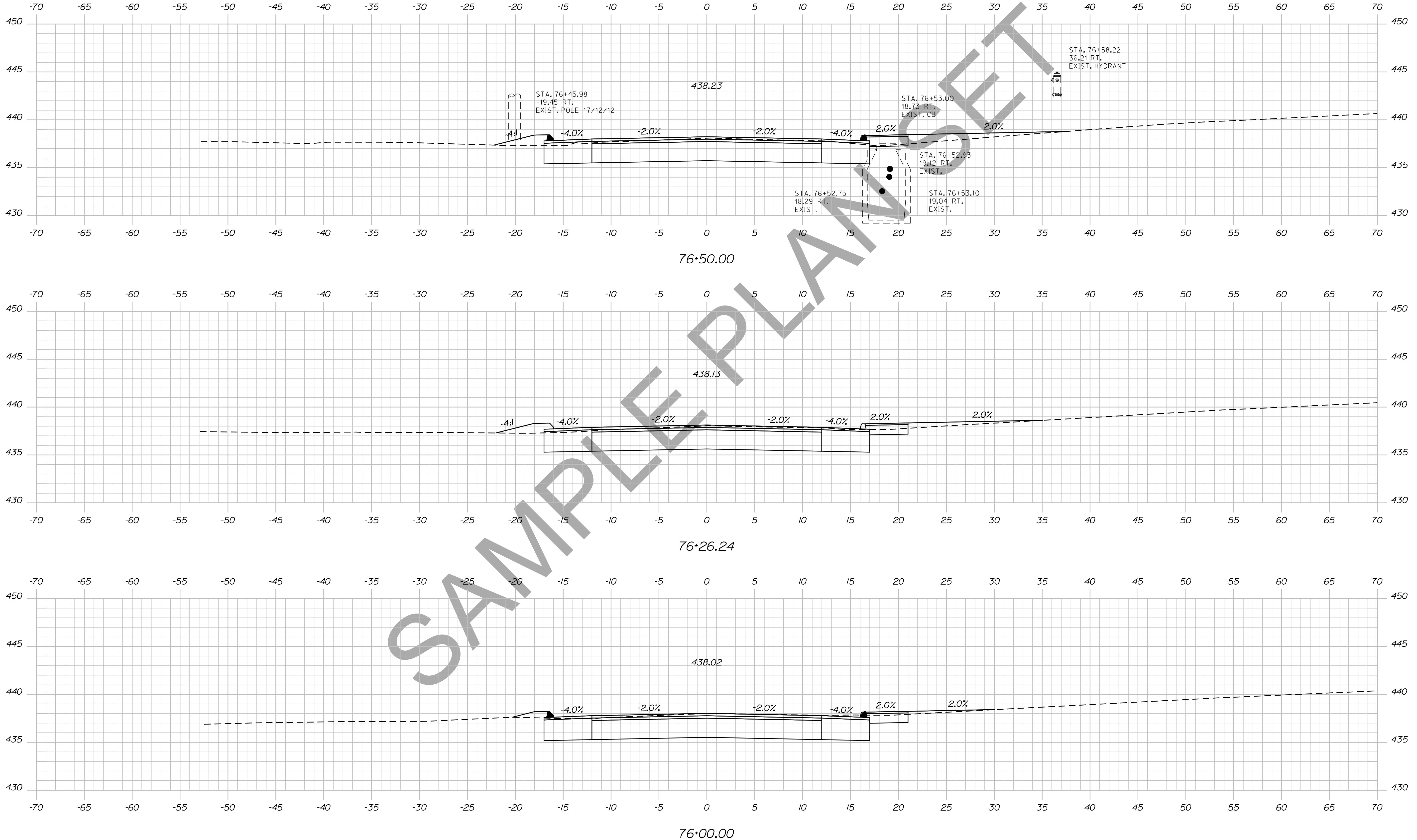

STATE OF MAINE
DEPARTMENT OF TRANSPORTATION
018246.00
WIN
PIN 18246.00
HIGHWAY PLANS

PROJ. MANAGER	BY	DATE	SIGNATURE
DESIGN-DETAILED	DESIGNER	DATE	SIGNATURE
CHECKED-REVIEWED	CHECKER	DATE	SIGNATURE
DESIGN-DETAILED	DESIGNER	DATE	SIGNATURE
DESIGN-DETAILED	DESIGNER	DATE	SIGNATURE
REVISIONS 1	DESIGNER	DATE	SIGNATURE
REVISIONS 2	DESIGNER	DATE	SIGNATURE
REVISIONS 3	DESIGNER	DATE	SIGNATURE
REVISIONS 4	DESIGNER	DATE	SIGNATURE
FIELD CHANGES	DESIGNER	DATE	SIGNATURE

DEXTER
ROUTE 7
CROSS SECTIONS

SHEET NUMBER
103
OF 15

Date: 12/10/2013

Username: atlee.mousseau

Division: HIGHWAY

Filename: ... \104_Xsect_76+72_080.dgn

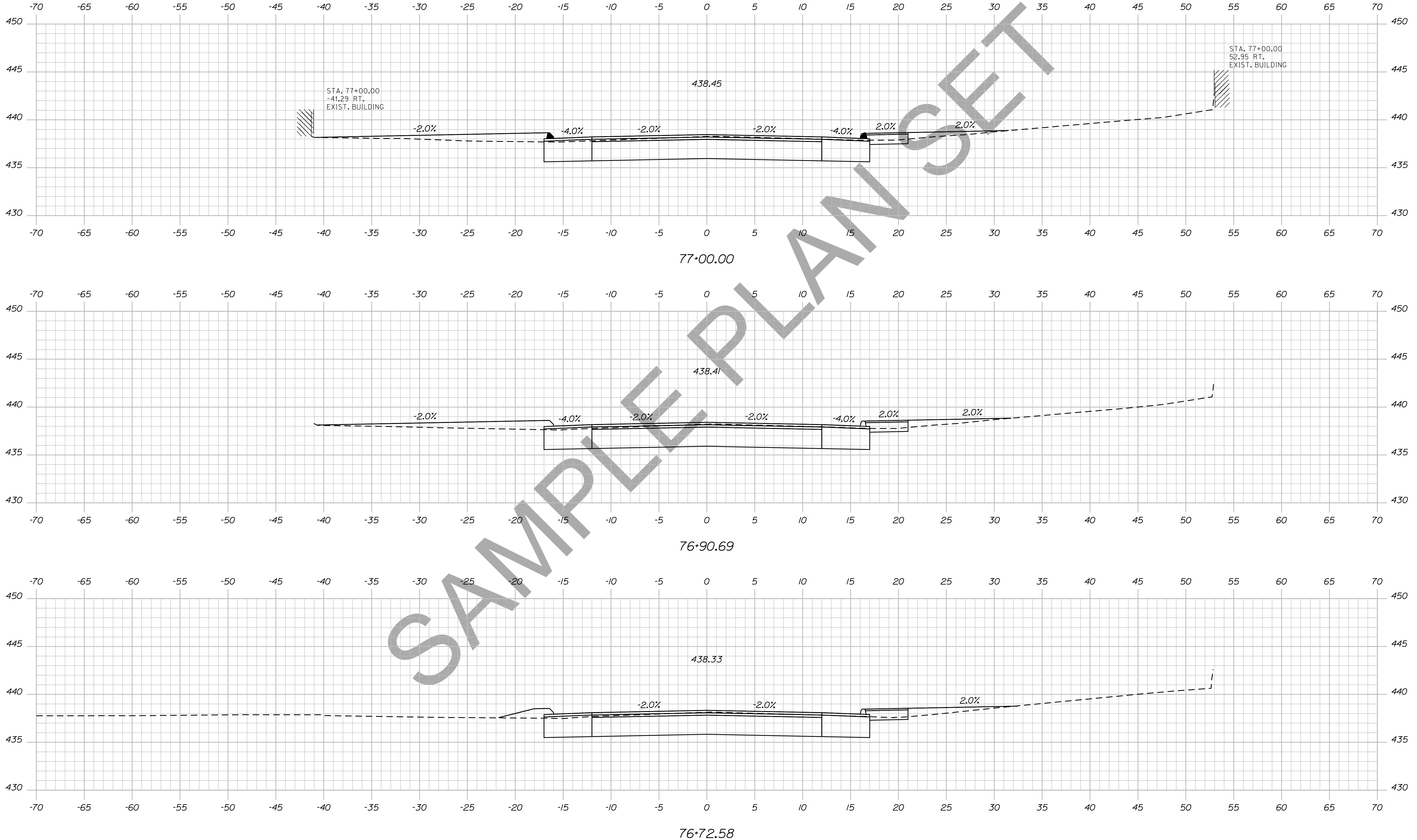

STATE OF MAINE
DEPARTMENT OF TRANSPORTATION
018246.00
WIN
PIN 18246.00
HIGHWAY PLANS

DESIGNER	DATE
CHECKED	BY
DESIGNED	PROJ. MGR.
REVISIONS 1	DESIGN DET.
REVISIONS 2	CHECKED
REVISIONS 3	DESIGNED
REVISIONS 4	REVISIONS
FIELD CHANGES	FIELD CHANGES

DEXTER
ROUTE 7
CROSS SECTIONS

SHEET NUMBER
104
OF 15

Date: 12/10/2013

Username: atlee.mousseau

Division: HIGHWAY

Filename: ... \105_Xsect_77+42_081.dgn

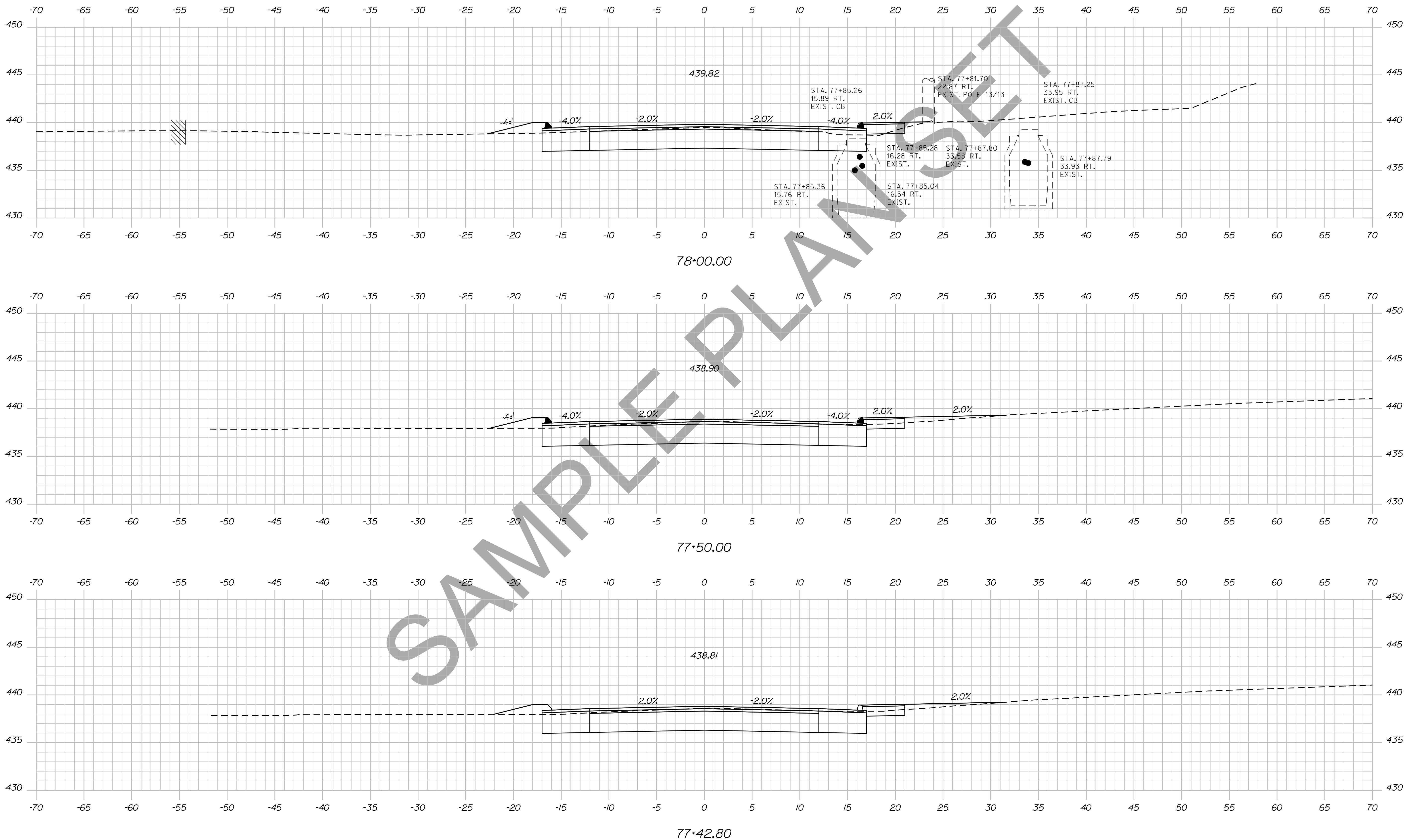

STATE OF MAINE
DEPARTMENT OF TRANSPORTATION
018246.00
WIN
PIN 18246.00
HIGHWAY PLANS

PROJ. MANAGER	PROJ. MANAGER'S	BY	DATE
DESIGN DETAILED	DESIGNER'S	BY	DATE
CHECKED-REVIEWED	CHECKER'S	BY	DATE
DESIGN DETAILED	DESIGNER'S	BY	DATE
DESIGN DETAILED	DESIGNER'S	BY	DATE
REVISIONS 1	REVISION'S	BY	DATE
REVISIONS 2	REVISION'S	BY	DATE
REVISIONS 3	REVISION'S	BY	DATE
REVISIONS 4	REVISION'S	BY	DATE
FIELD CHANGES	FIELD CHANGES	BY	DATE

DEXTER
ROUTE 7
CROSS SECTIONS

SHEET NUMBER
105
OF 15

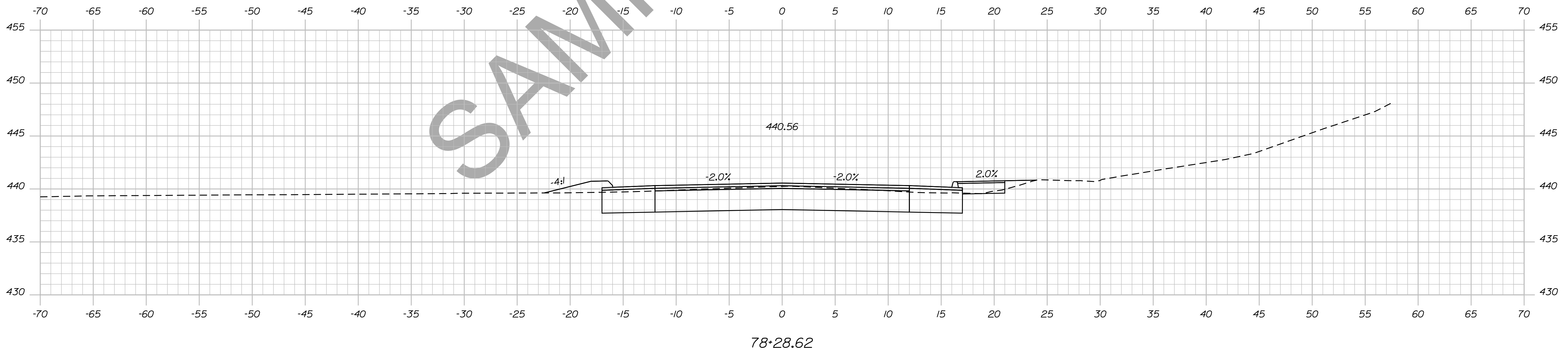
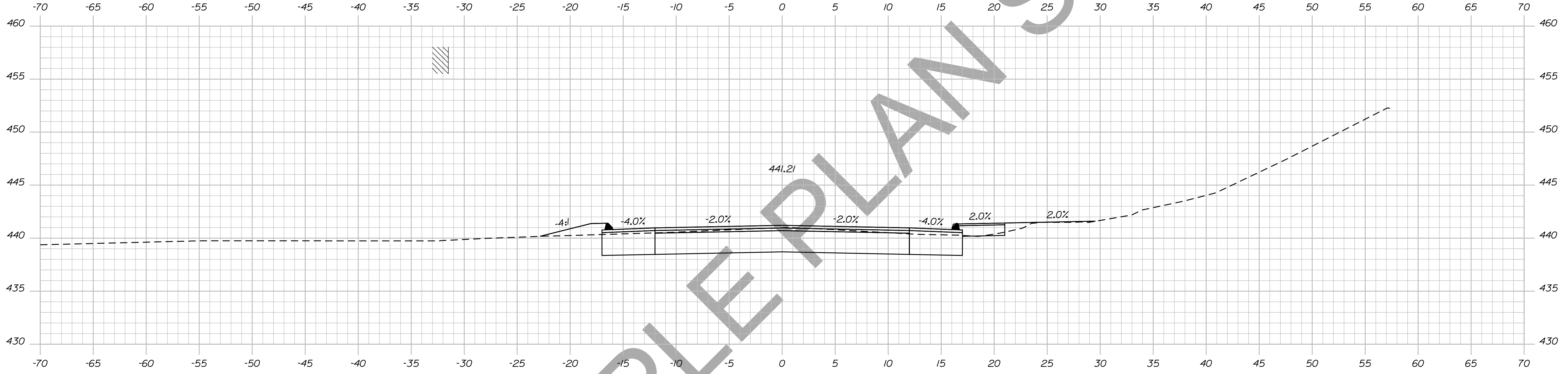

STATE OF MAINE
DEPARTMENT OF TRANSPORTATION
018246.00
WIN
PIN 18246.00
HIGHWAY PLANS

PROJ. MANAGER	BY	DATE	SIGNATURE
DESIGN-DETAILED	DESIGNER	DATE	
CHECKED-REVIEWED	CHECKER	DATE	
DESIGN-DETAILED	DESIGNER	DATE	
DESIGN-DETAILED	DESIGNER	DATE	
REVISIONS 1	REVISOR	DATE	
REVISIONS 2	REVISOR	DATE	
REVISIONS 3	REVISOR	DATE	
REVISIONS 4	REVISOR	DATE	
FIELD CHANGES	FIELD	DATE	

DEXTER
ROUTE 7
CROSS SECTIONS

SHEET NUMBER
106
OF 15

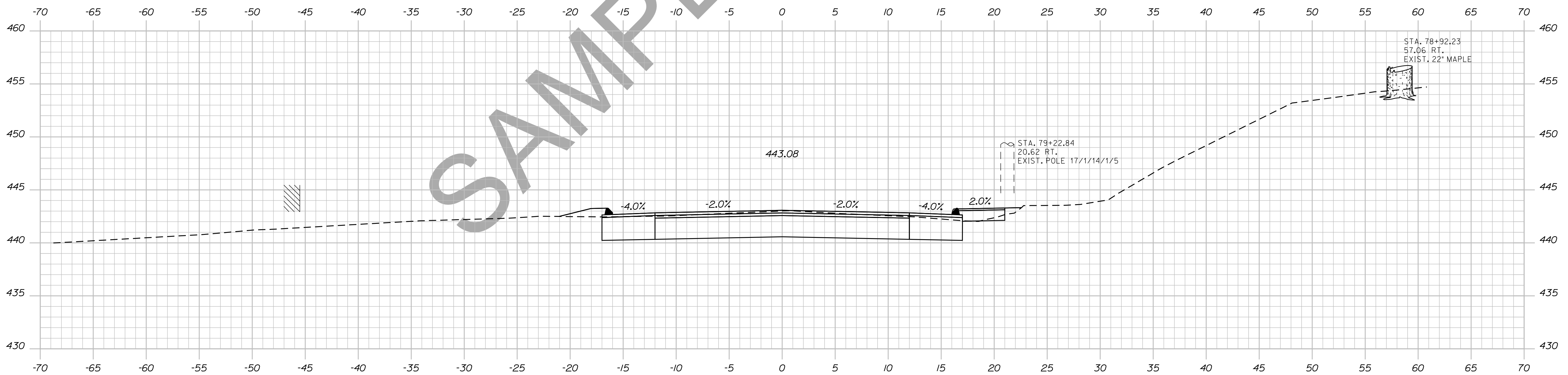
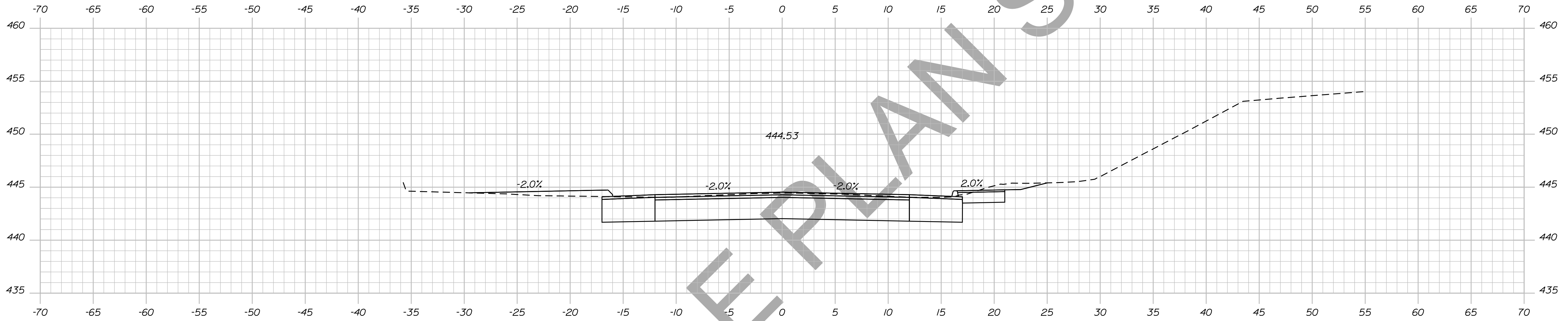

79+00.00

79+33.30

STATE OF MAINE
DEPARTMENT OF TRANSPORTATION
018246.00
WIN
PIN 18246.00
HIGHWAY PLANS

PROJ. MANAGER	BY	DATE	SIGNATURE
DESIGN-DETAILED	DESIGNER	DATE	
CHECKED-REVIEWED	CHECKER	DATE	
DESIGN-DETAILED	DESIGNER	DATE	
DESIGN-DETAILED	DESIGNER	DATE	
REVISIONS 1	REVISOR	DATE	
REVISIONS 2	REVISOR	DATE	
REVISIONS 3	REVISOR	DATE	
REVISIONS 4	REVISOR	DATE	
FIELD CHANGES	FIELD	DATE	

DEXTER
ROUTE 7
CROSS SECTIONS

SHEET NUMBER
107
OF 15

Date: 12/10/2013

Username: atlee.mousseau

Division: HIGHWAY

Filename: ... \108_Xsect_79+50_084.dgn

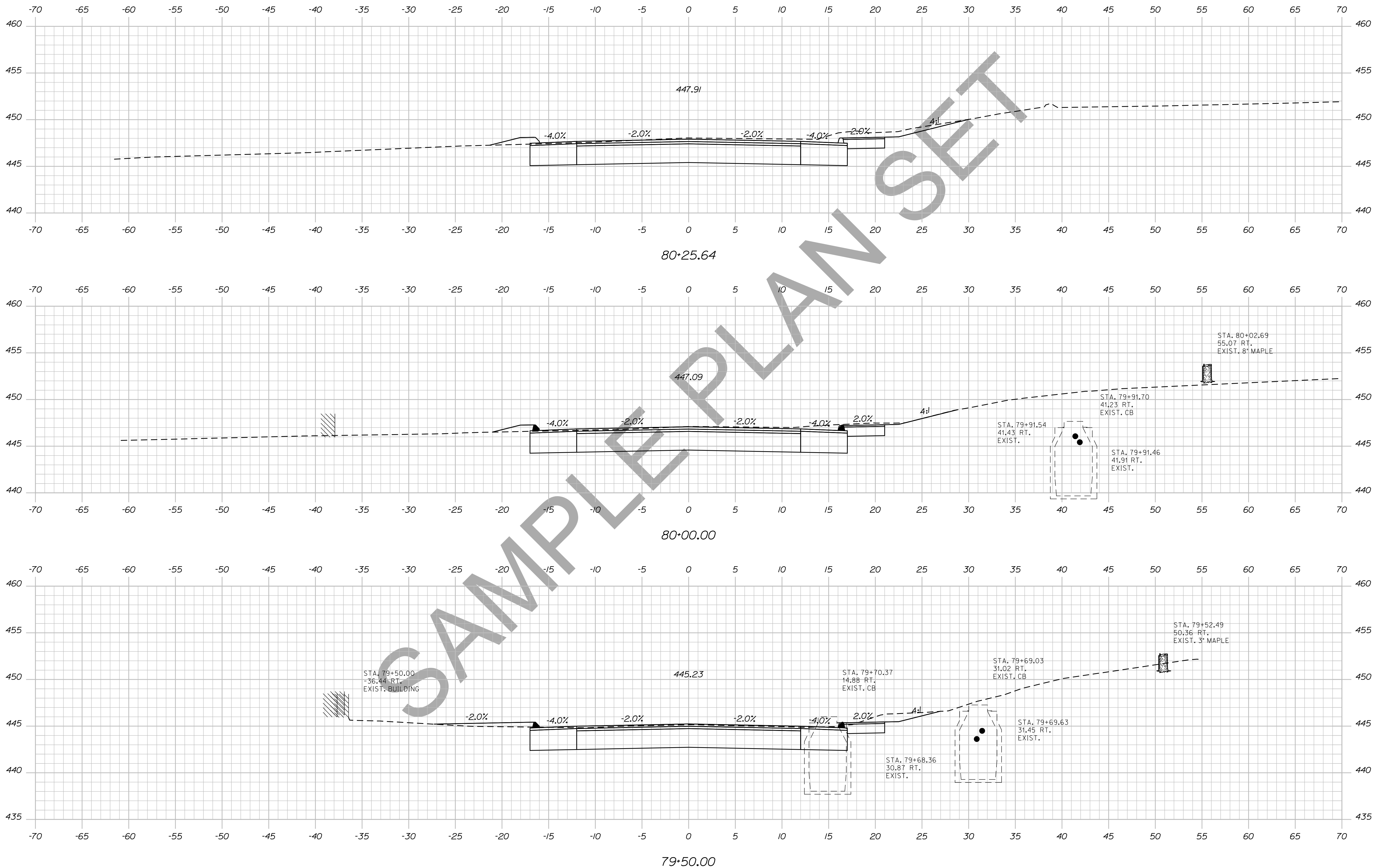

STATE OF MAINE
DEPARTMENT OF TRANSPORTATION
018246.00
WIN
PIN 18246.00
HIGHWAY PLANS

PROJ. MANAGER	BY	DATE	SIGNATURE	P.E. NUMBER	DATE
DESIGN-DETAILED	DESIGNER	DATE			
CHECKED-REVIEWED	CHECKER	DATE			
DESIGNS DETAILING	DESIGNER	DATE			
DESIGNS DETAILING	DESIGNER	DATE			
REVISIONS 1					
REVISIONS 2					
REVISIONS 3					
REVISIONS 4					
FIELD CHANGES					

DEXTER
ROUTE 7
CROSS SECTIONS

SHEET NUMBER
108
OF 15

Date: 12/10/2013

Username: atlee.mousseau

Division: HIGHWAY

Filename: ... \109_Xsect_80+50_085.dgn

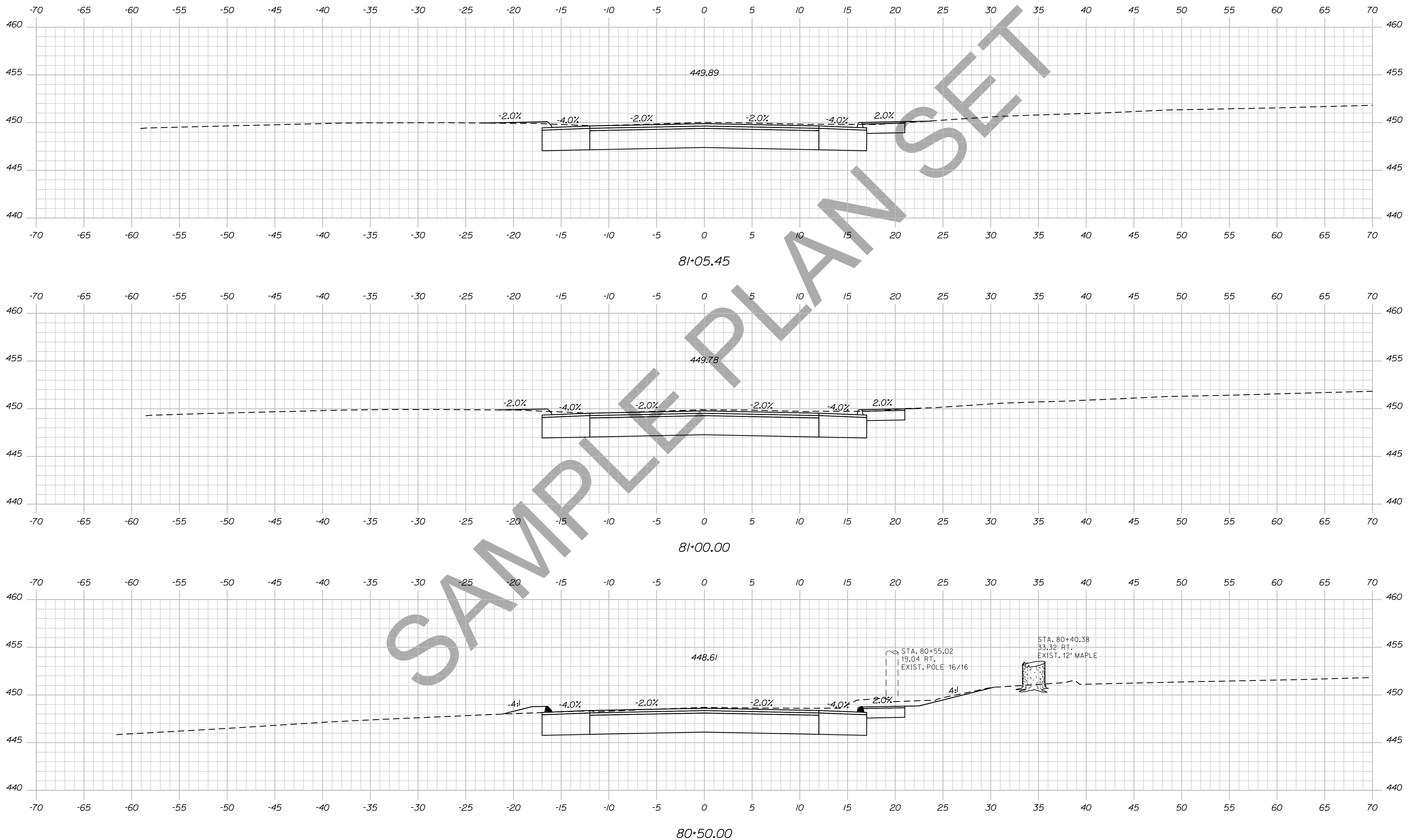

SAMPLE PLAN SET

STATE OF MAINE DEPARTMENT OF TRANSPORTATION			
			018246.00
		WIN	PIN 18246.00
HIGHWAY PLANS			
		SIGNATURE	
		P.E. NUMBER	
		DATE	
PROJ. MANAGER	BY	DATE	
DESIGN-DETAILED	DESIGNER	DATE	
CHECKED-REVIEWED	CHECKER	DATE	
DESIGNS DET AILED 1	DESIGNER 1	DATE 1	
REVISIONS 1	REVISOR 1	DATE 1	
DESIGNS DET AILED 2	DESIGNER 2	DATE 2	
REVISIONS 2	REVISOR 2	DATE 2	
DESIGNS DET AILED 3	DESIGNER 3	DATE 3	
REVISIONS 3	REVISOR 3	DATE 3	
DESIGNS DET AILED 4	DESIGNER 4	DATE 4	
REVISIONS 4	REVISOR 4	DATE 4	
FIELD CHANGES	FIELD CHANGES	FIELD CHANGES	
DEXTER ROUTE 7 CROSS SECTIONS			
SHEET NUMBER			
109			
OF 15			

Date: 12/10/2013

Username: atlee,mousseau

Division: HIGHWAY

Filename: ... \110_xsect_81+50_086.dgn

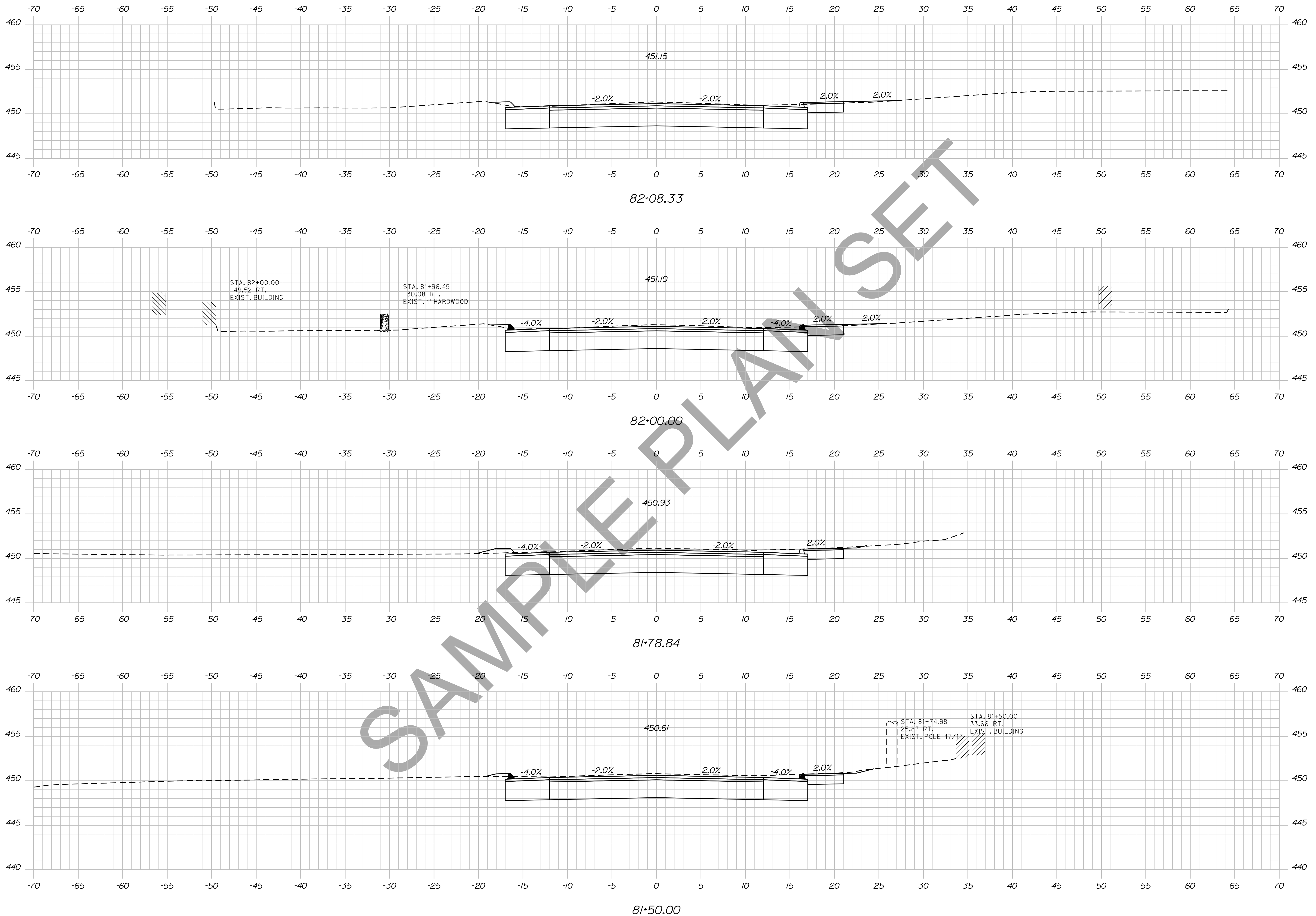

STATE OF MAINE
DEPARTMENT OF TRANSPORTATION
018246.00
WIN
PIN 18246.00
HIGHWAY PLANS

PROJ. MANAGER	BY	DATE	SIGNATURE
DESIGN-DETAILED	DESIGNER	DATE	SIGNATURE
CHECKED-REVIEWED	CHECKER	DATE	SIGNATURE
DESIGN-DETAILED	DESIGNER	DATE	SIGNATURE
DESIGN-DETAILED	DESIGNER	DATE	SIGNATURE
REVISIONS 1	DESIGNER	DATE	SIGNATURE
REVISIONS 2	DESIGNER	DATE	SIGNATURE
REVISIONS 3	DESIGNER	DATE	SIGNATURE
REVISIONS 4	DESIGNER	DATE	SIGNATURE
FIELD CHANGES	DESIGNER	DATE	SIGNATURE

DEXTER
ROUTE 7
CROSS SECTIONS

SHEET NUMBER
110
OF 15

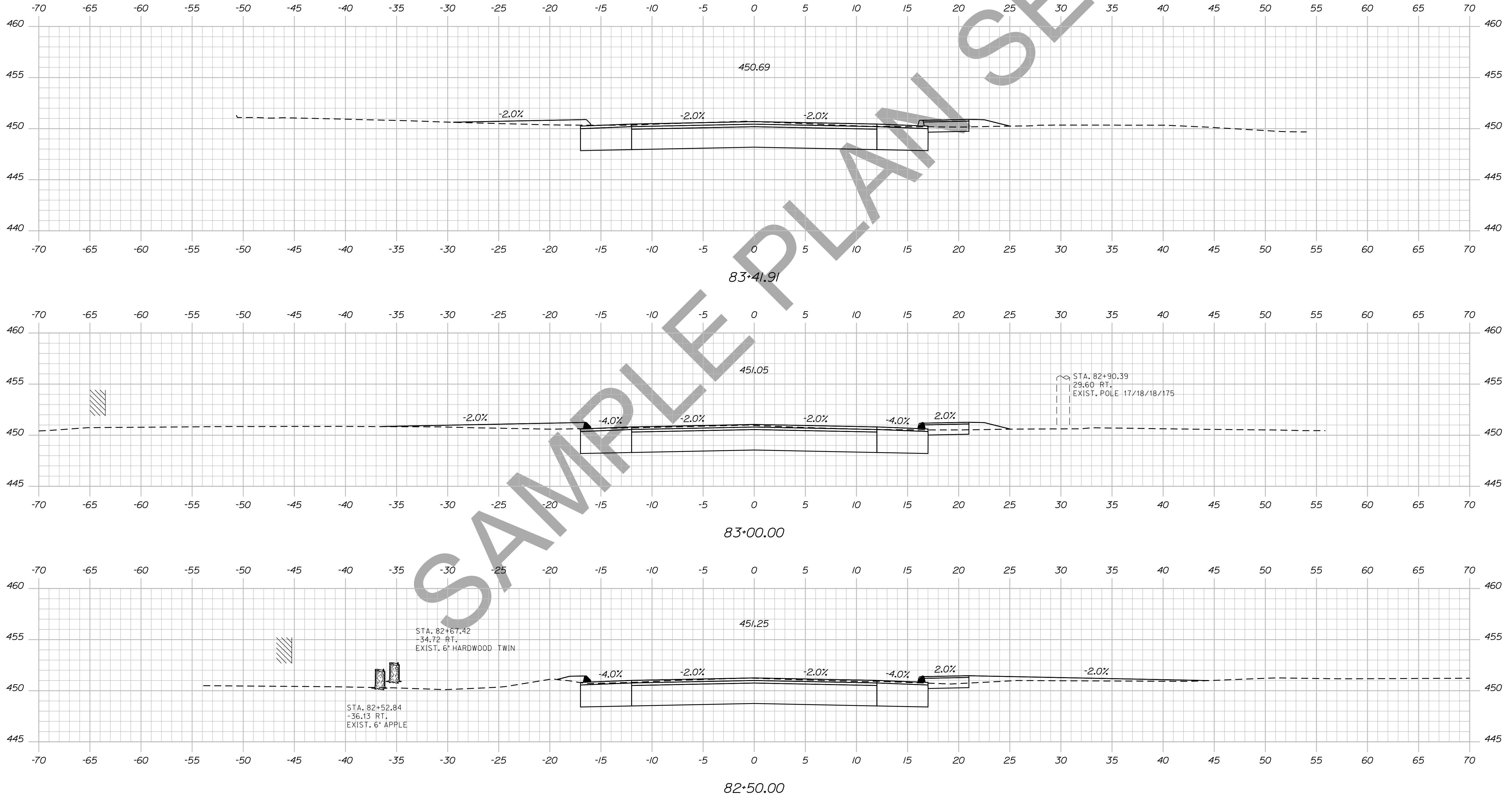

STATE OF MAINE
 DEPARTMENT OF TRANSPORTATION
 018246.00
 WIN
 PIN 18246.00
 HIGHWAY PLANS

PROJ. MANAGER	DESIGN-DETAILED	CHECKED-REVIEWED	DESIGN-DETAILED	REVISIONS 1	REVISIONS 2	REVISIONS 3	REVISIONS 4	FIELD CHANGES

BY	DATE	SIGNATURE	P.E. NUMBER	DATE

DEXTER
 ROUTE 7
 CROSS SECTIONS

SHEET NUMBER
 111
 OF 15

Date: 12/10/2013

Username: atlee.mousseau

Division: HIGHWAY

Filename: ... \112_xsect_83+50_088.dgn

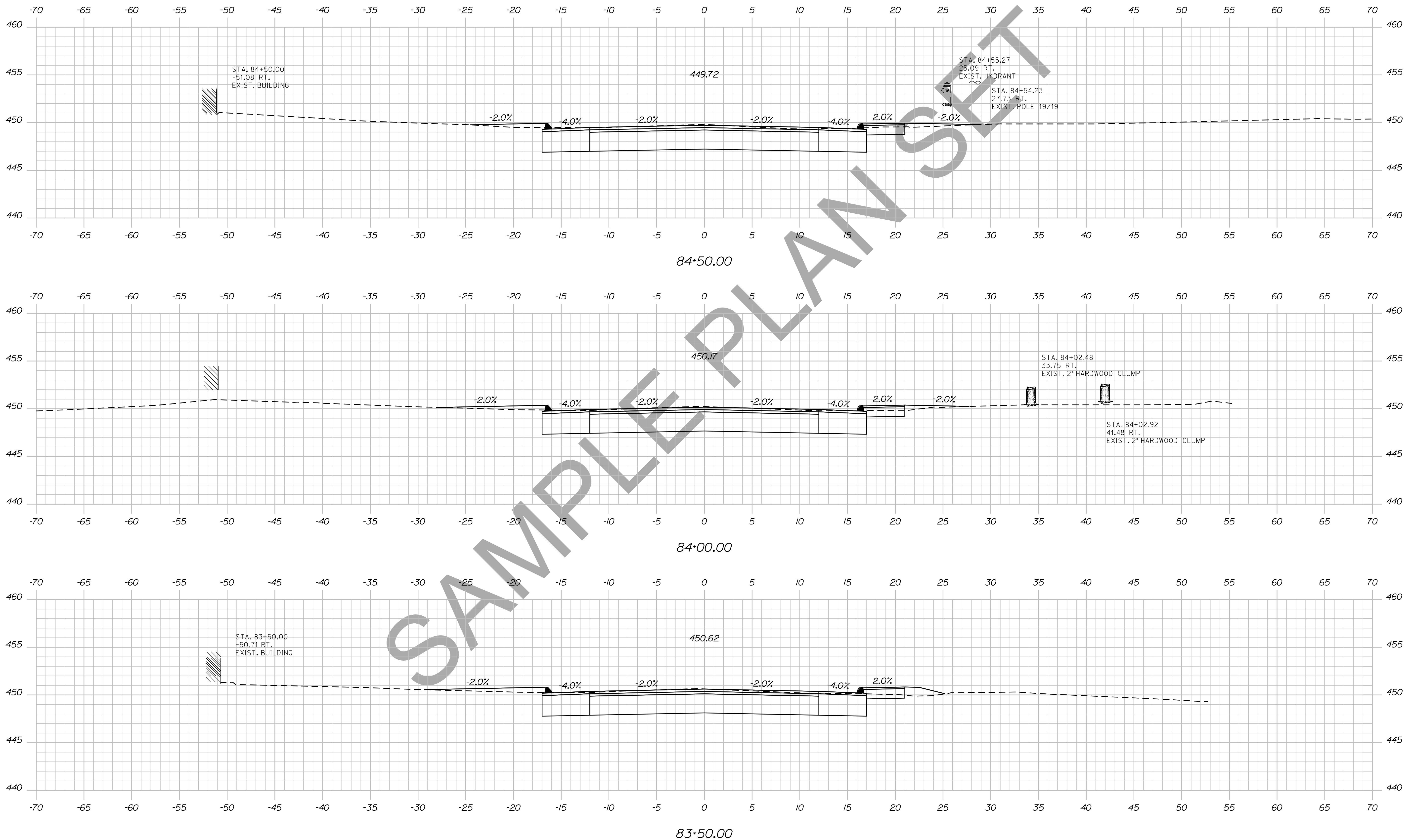

STATE OF MAINE	
DEPARTMENT OF TRANSPORTATION	
018246.00	WIN
PIN 18246.00	
HIGHWAY PLANS	
SIGNATURE	P.E. NUMBER
DATE	DATE
PROJ. MANAGER	BY
DESIGN DETAILED	DATE
CHECKED-REVIEWED	DESIGNER
DESIGNS DET AILED	PROJ. NO.
DESIGNS DET AILED	PROJ. NO.
REVISIONS 1	REVISIONS 1
REVISIONS 2	REVISIONS 2
REVISIONS 3	REVISIONS 3
REVISIONS 4	REVISIONS 4
FIELD CHANGES	FIELD CHANGES
DEXTER ROUTE 7	
CROSS SECTIONS	
SHEET NUMBER	
112	
OF 15	

Date: 12/10/2013

Username: atlee.mousseau

Division: HIGHWAY

Filename: ... \113_xsect_84+57_089.dgn

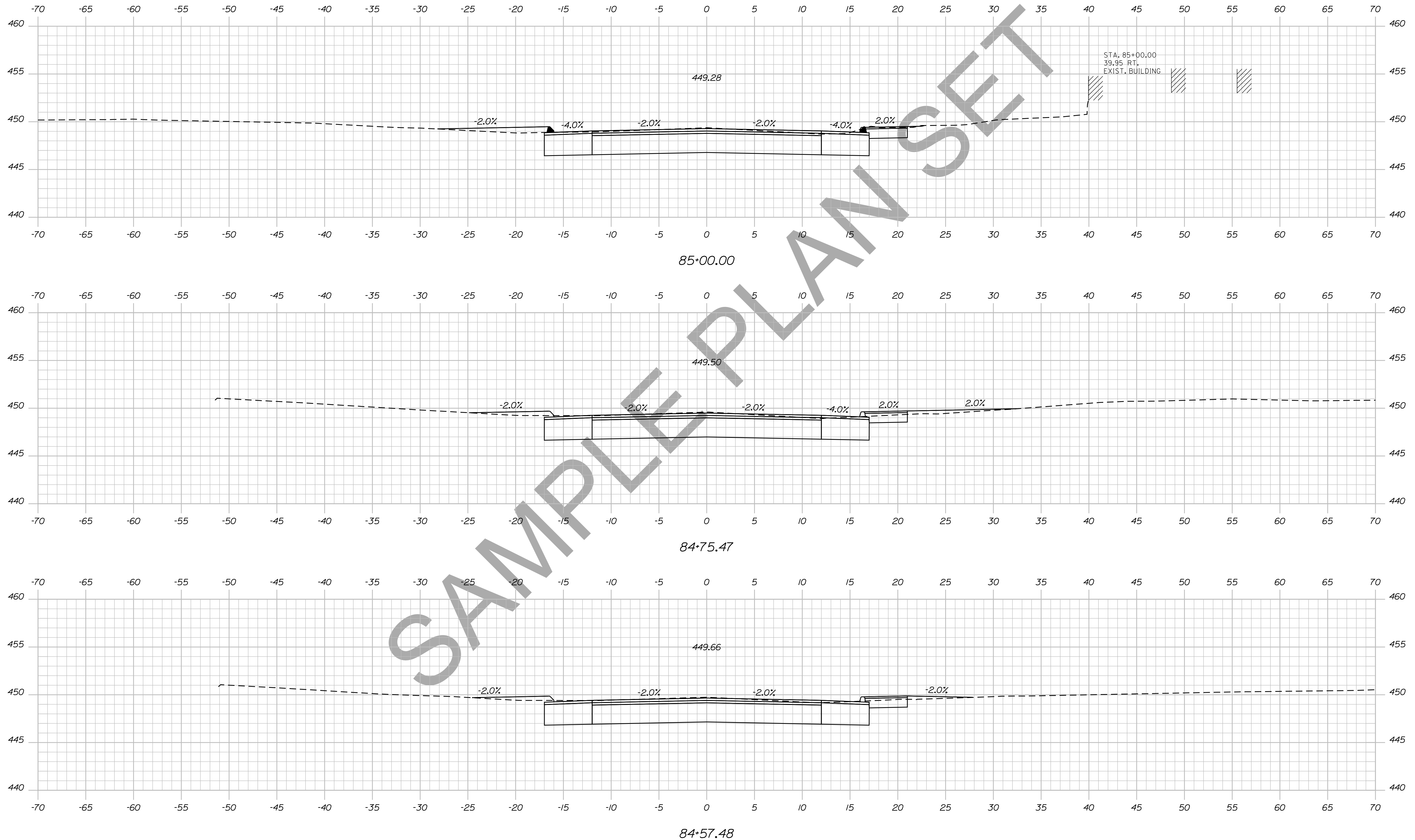

STATE OF MAINE
DEPARTMENT OF TRANSPORTATION
018246.00

WIN
PIN 18246.00
HIGHWAY PLANS

PROJ. MANAGER	DESIGN DETAILED	CHECKED-REVIEWED	DESIGN DETAILED	DESIGN DETAILED	DESIGN DETAILED	DESIGN DETAILED	DESIGN DETAILED	DESIGN DETAILED	DESIGN DETAILED	DATE

DEXTER
ROUTE 7
CROSS SECTIONS

SHEET NUMBER
113
OF 15

Date: 12/10/2013

Username: atlee.mousseau

Division: HIGHWAY

Filename: ... \114_xsect_85+50_090.dgn

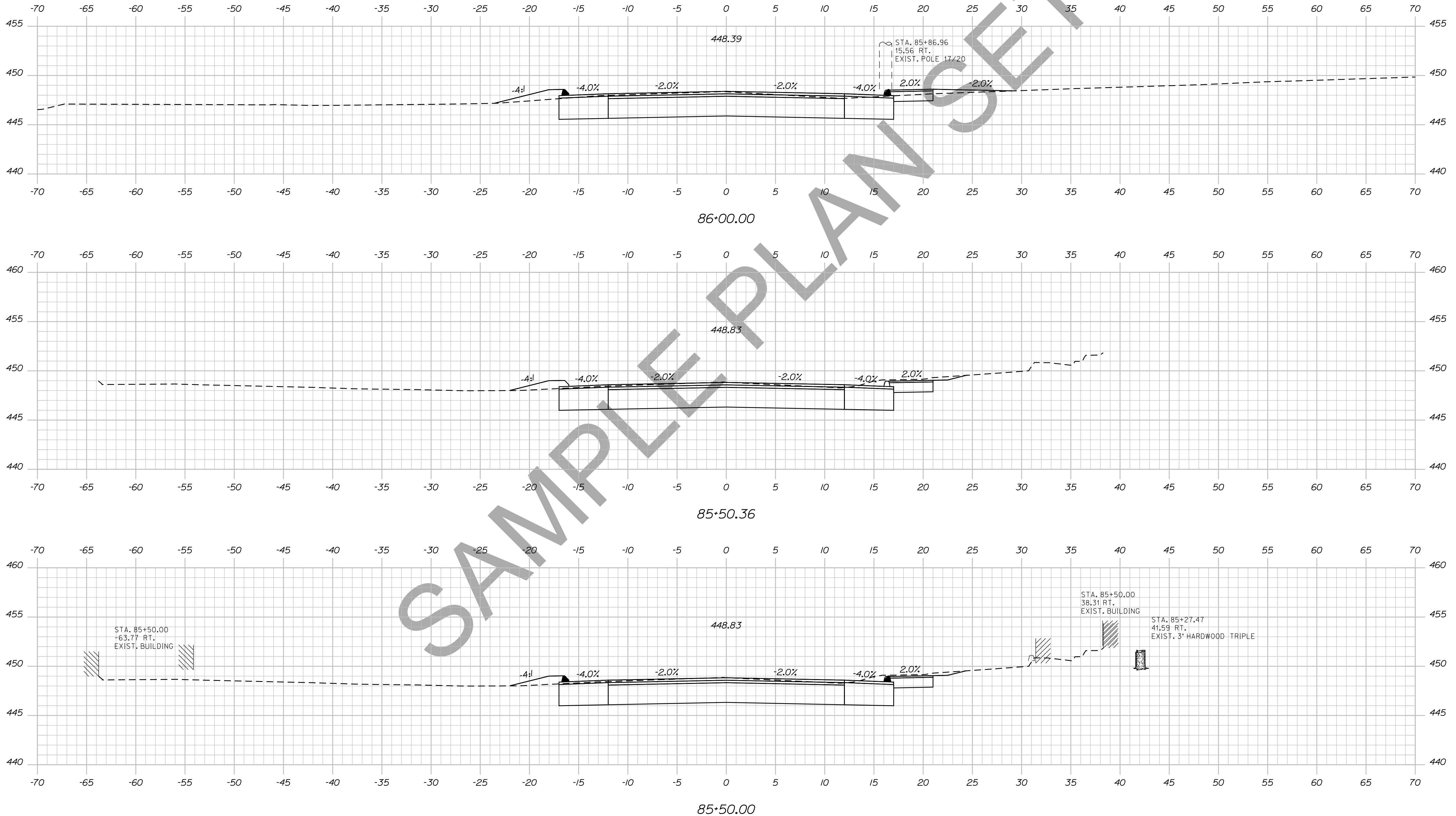

STATE OF MAINE
DEPARTMENT OF TRANSPORTATION
018246.00
WIN
PIN 18246.00
HIGHWAY PLANS

PROJ. MANAGER	BY	DATE	SIGNATURE	P.E. NUMBER	DATE
DESIGN-DETAILED	DESIGNER	DATE			
CHECKED-REVIEWED	CHECKER	DATE			
DESIGN-DETAILED	DESIGNER	DATE			
DESIGN-DETAILED	DESIGNER	DATE			
REVISIONS 1					
REVISIONS 2					
REVISIONS 3					
REVISIONS 4					
FIELD CHANGES					

DEXTER
ROUTE 7
CROSS SECTIONS

SHEET NUMBER
114
OF 15

Date: 12/10/2013

Username: atlee.mousseau

Division: HIGHWAY

Filename: ... \115_xsect_86-04_091.dgn

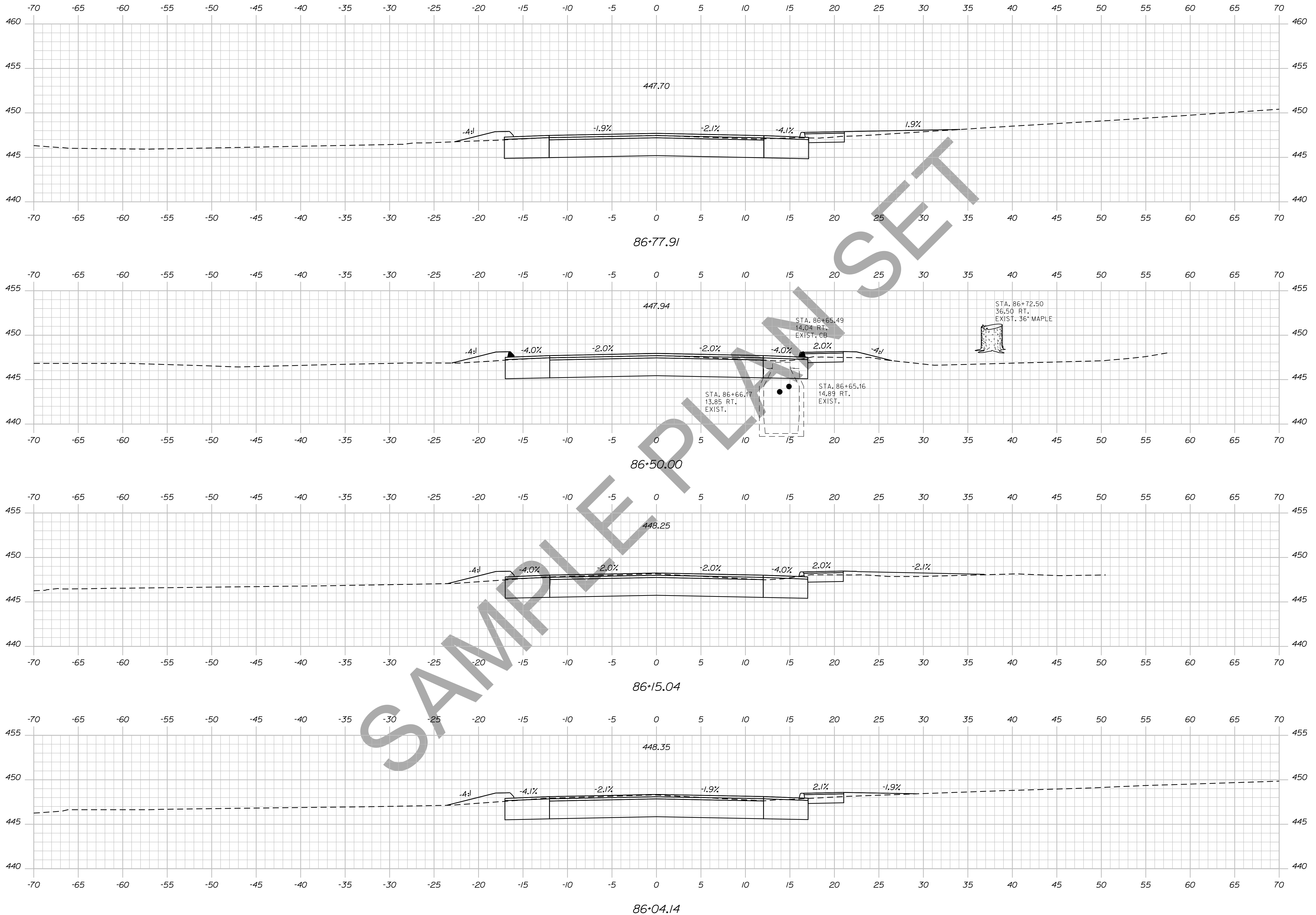

STATE OF MAINE DEPARTMENT OF TRANSPORTATION		018246.00		WIN PIN 18246.00		HIGHWAY PLANS	
SIGNATURE		P.E. NUMBER		DATE		FIELD CHANGES	
DESIGN-DETAILED	CHECKED-REVIEWED	DESIGNS-DETAILED	DESIGNS-DETAILED	REVISIONS 1	REVISIONS 2	REVISIONS 3	REVISIONS 4
DESIGNER	CHECKER	DESIGNER	DESIGNER	REVISIONS 1	REVISIONS 2	REVISIONS 3	REVISIONS 4
DATE	DATE	DATE	DATE	DATE	DATE	DATE	DATE
DEXTER ROUTE 7				CROSS SECTIONS			
SHEET NUMBER				115			
				OF 15			

Username: atlee.mousseau Date: 12/10/2013

Division: HIGHWAY

Filename: ... \116_Xsect_86+91_092.dgn

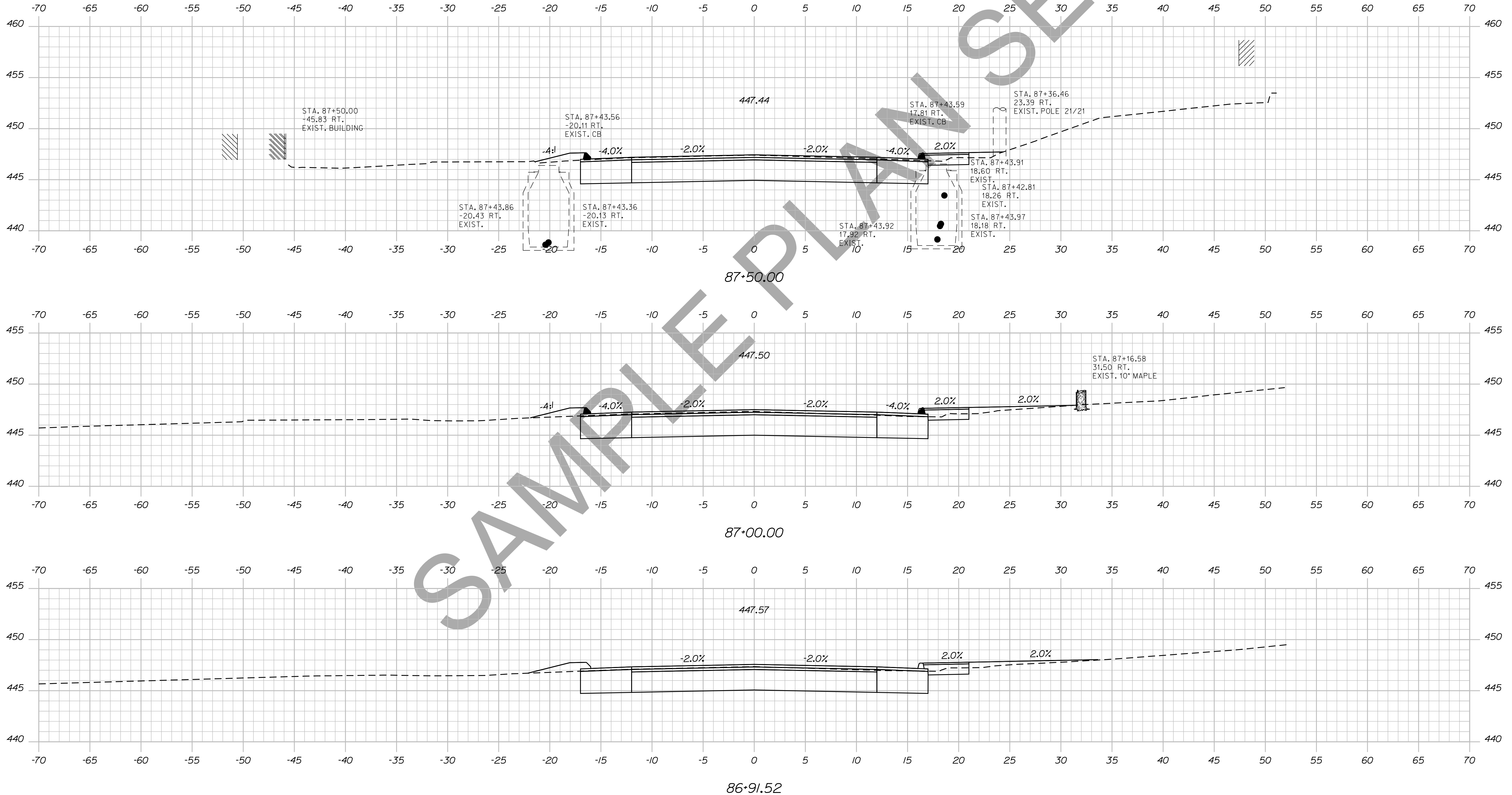

STATE OF MAINE
DEPARTMENT OF TRANSPORTATION
018246.00
WIN
PIN 18246.00
HIGHWAY PLANS

SIGNATURE
P.E. NUMBER
DATE

PROJ. MANAGER	DESIGN-DETAILED	CHECKED-REVIEWED	DESIGNS DET. TAILED	REVISIONS 1	REVISIONS 2	REVISIONS 3	REVISIONS 4	FIELD CHANGES

DEXTER
ROUTE 7
CROSS SECTIONS

SHEET NUMBER
116
OF 15

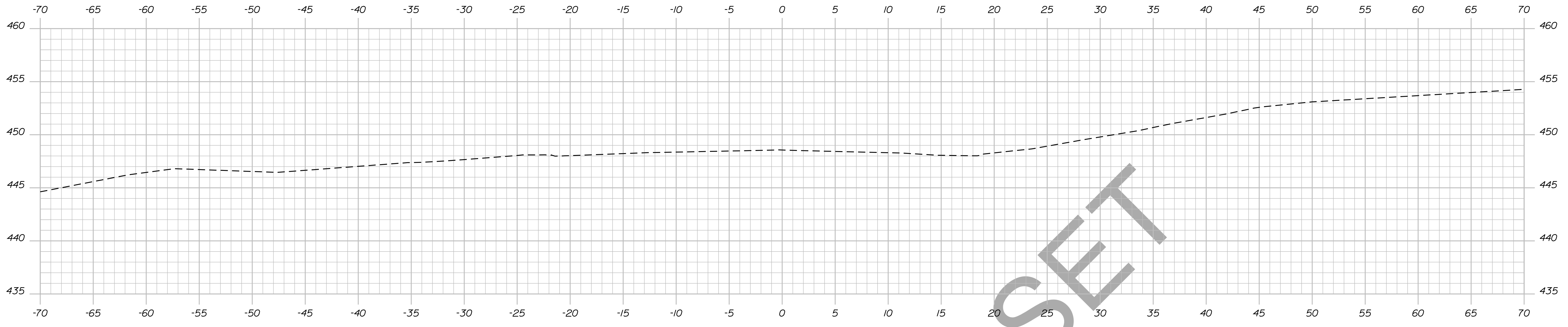

88+00.00

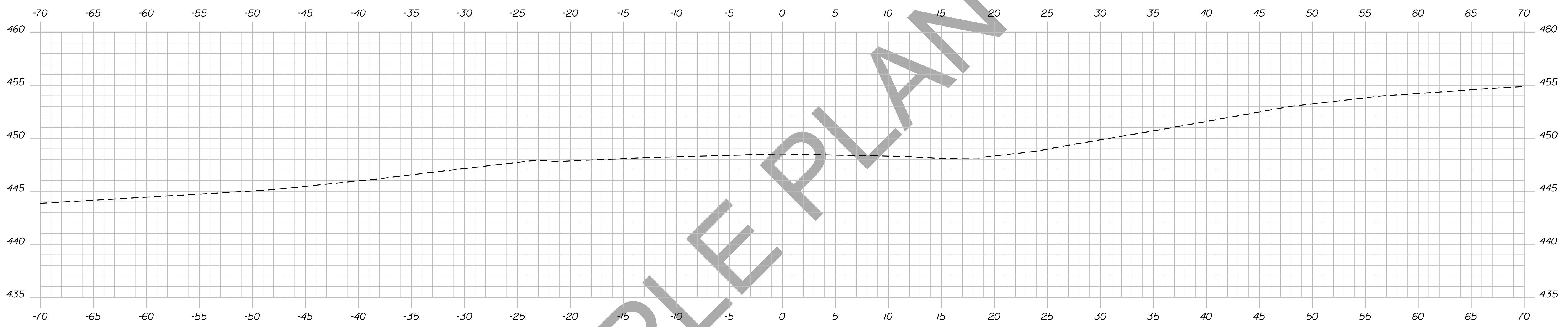

87+98.51

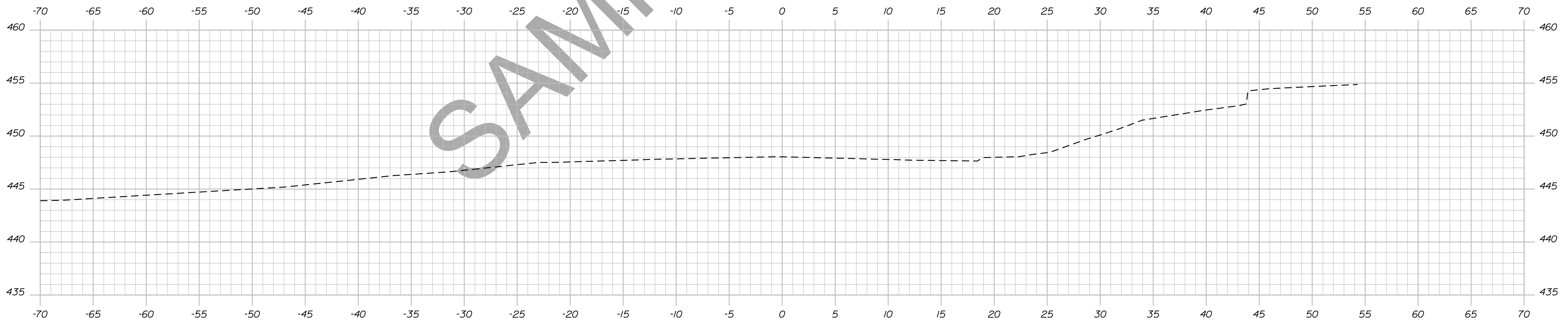

87+85.61

SAMPLE PLAN SET

STATE OF MAINE
DEPARTMENT OF TRANSPORTATION

018246.00
WIN
PIN 18246.00
HIGHWAY PLANS

SIGNATURE

DATE

BY

PROJ. MANAGER

CHECKED-REVIEWED

DESIGN DET. TAILED

DESIGN DET. TAILED

DESIGN DET. TAILED

DESIGN DET. TAILED

DESIGN DET. TAILED

DESIGN DET. TAILED

DESIGN DET. TAILED

DESIGN DET. TAILED

DESIGN DET. TAILED

DESIGN DET. TAILED

DESIGN DET. TAILED

DESIGN DET. TAILED

DESIGN DET. TAILED

DESIGN DET. TAILED

DEXTER
ROUTE 7

CROSS SECTIONS

SHEET NUMBER

117

OF 15

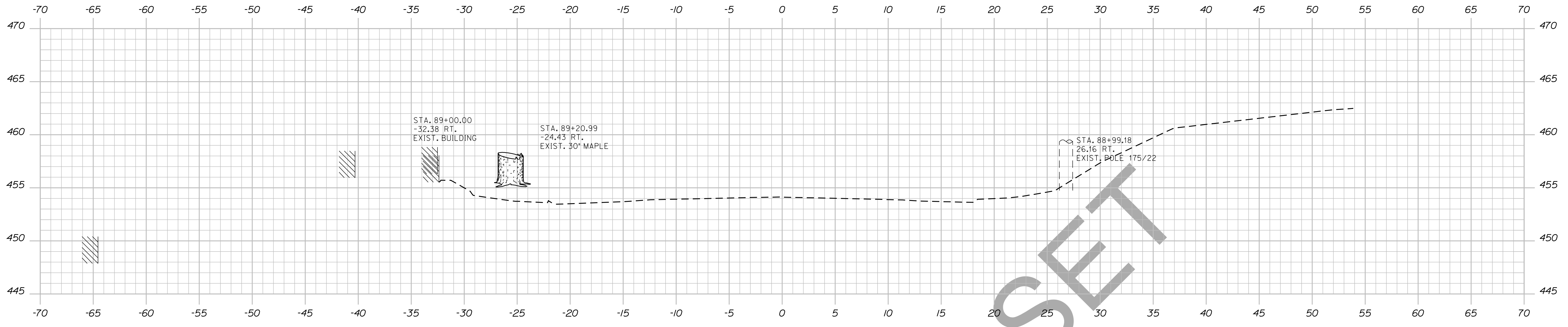

89+00.00

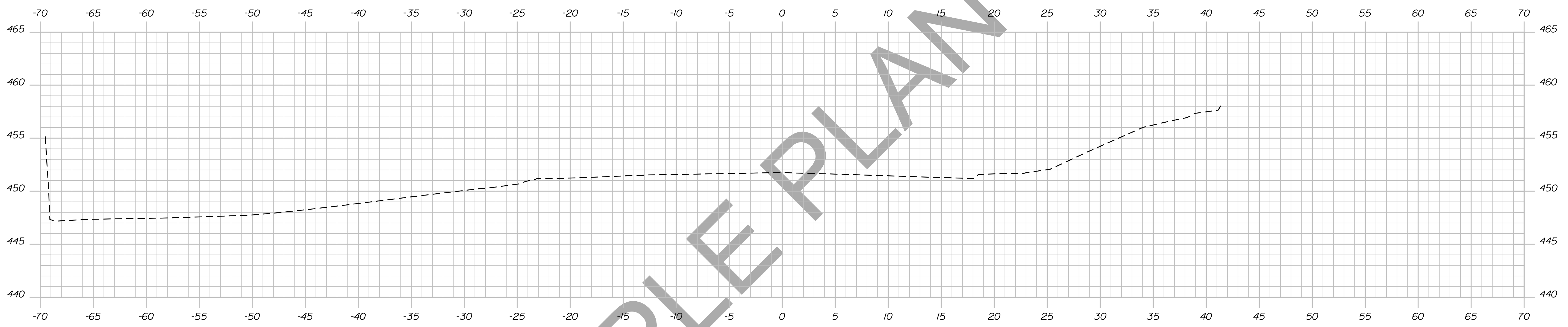

88+64.91

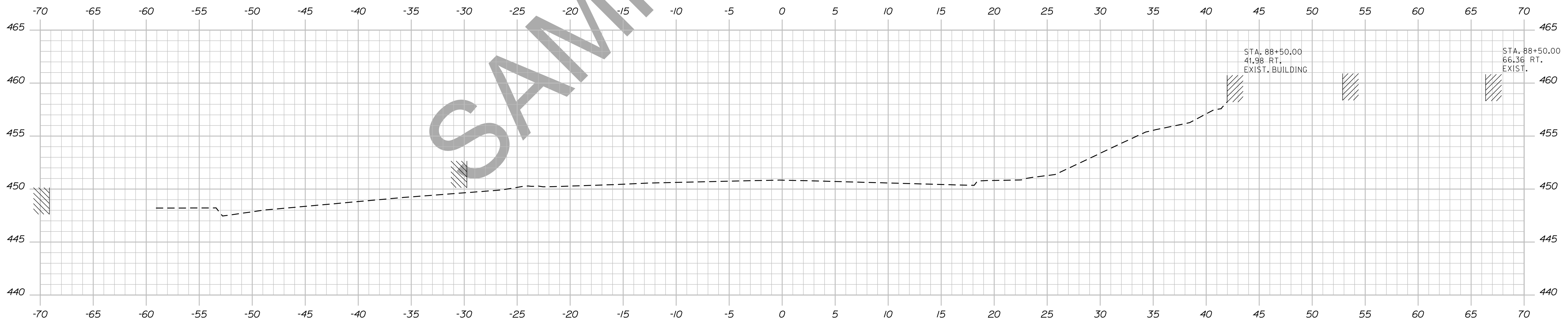

88+50.00

STATE OF MAINE
DEPARTMENT OF TRANSPORTATION
018246-00
WIN
PIN 18246.00
HIGHWAY PLANS

PROJ. MANAGER	DESIGN DETAILED	CHECKED	BY	DATE	SIGNATURE
\$ProjectMgr\$	\$Designer\$	\$Checker\$	\$Designer\$	\$Date\$	\$Signature\$
	DESIGNS DET AILED 1	DESIGNS DET AILED 2	DESIGNS DET AILED 3	DESIGNS DET AILED 4	P. E. NUMBER
	REVISIONS 1	REVISIONS 2	REVISIONS 3	REVISIONS 4	DATE
	FIELD CHANGES				

DEXTER
ROUTE 7
CROSS SECTIONS

SHEET NUMBER
118
OF 15

Filename: ... \119_Xsect_89+50_095.dgn

Division: HIGHWAY

Username: atlee,mousseau

Date: 12/10/2013

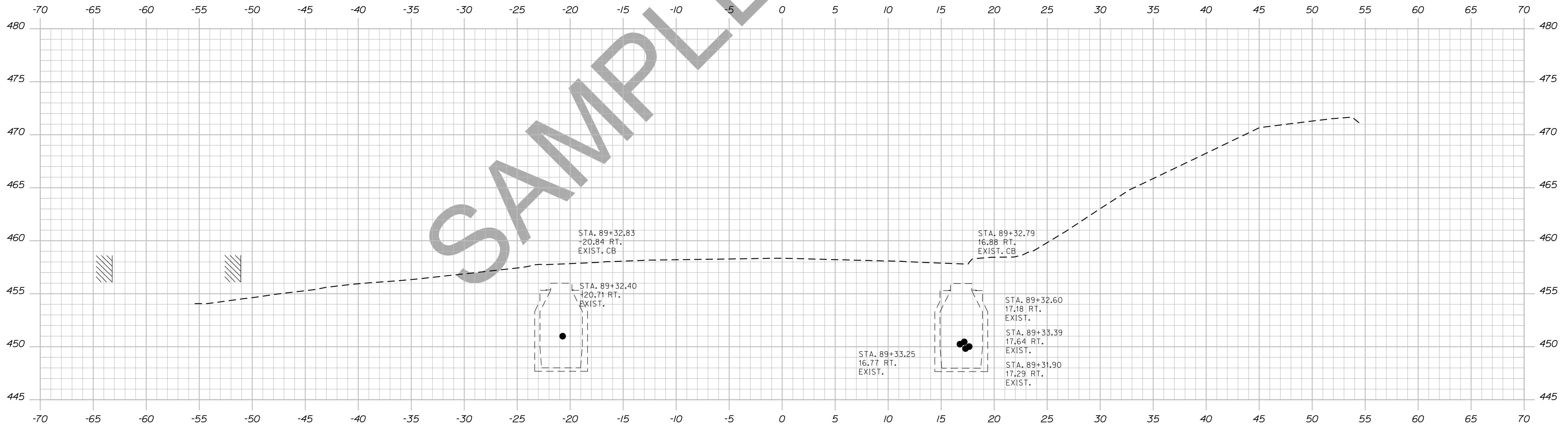
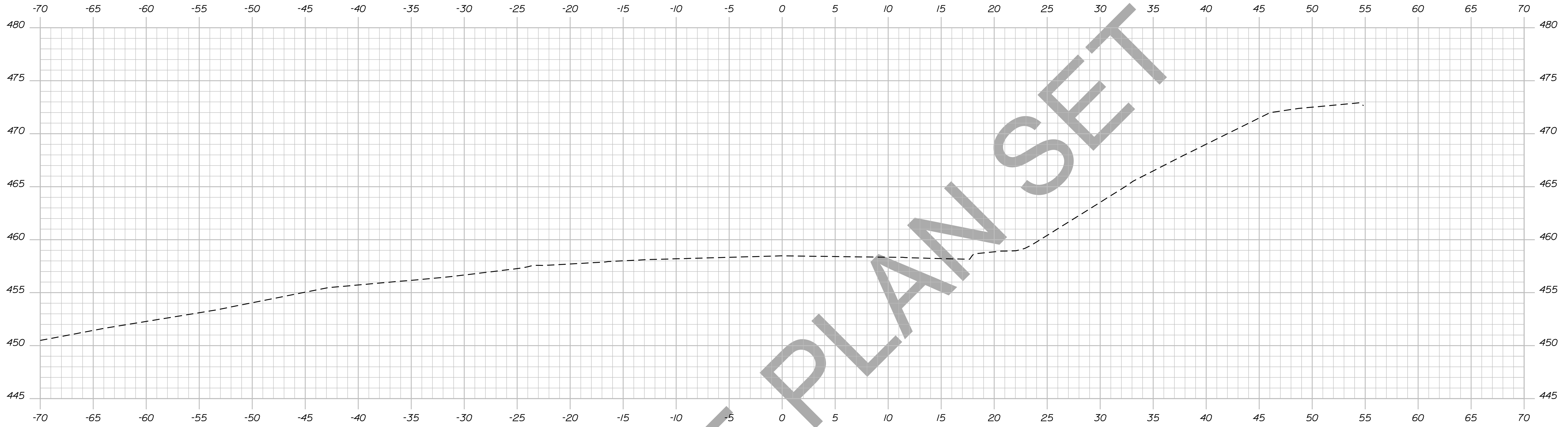

STATE OF MAINE
DEPARTMENT OF TRANSPORTATION
018246.00

PROJ. MANAGER	DESIGN-DETAILED	CHECKED-REVIEWED	DESIGN-DETAILED	DESIGN-DETAILED	REVISIONS 1	REVISIONS 2	REVISIONS 3	REVISIONS 4	FIELD CHANGES
BY	DATE	SIGNATURE	P.E. NUMBER	DATE					

DEXTER
ROUTE 7
CROSS SECTIONS

SHEET NUMBER
119
OF 15

Username: atlee,mousseau Date:12/10/2013

Division: HIGHWAY

Filename: ... \120_Xsect_90+00_096.dgn

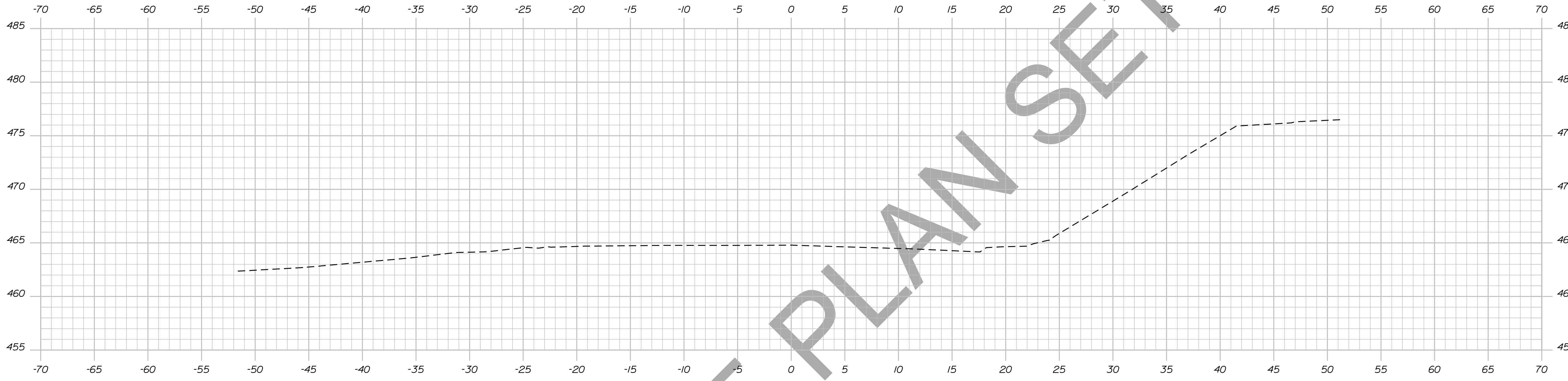

90+18.51

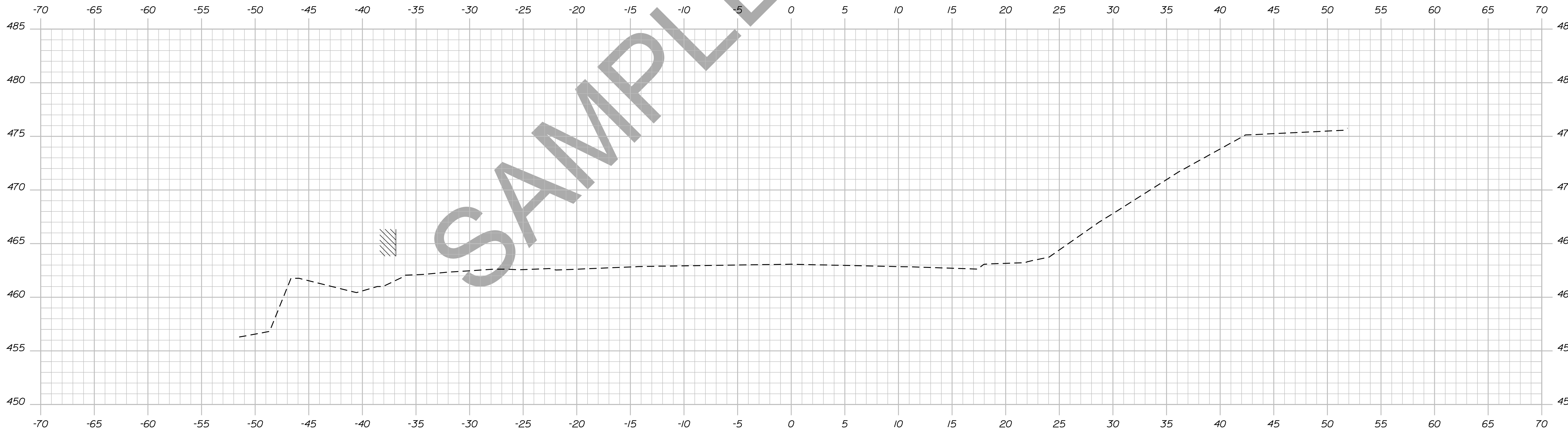

90+00.00

STATE OF MAINE
DEPARTMENT OF TRANSPORTATION
018246.00
WIN
PIN 18246.00
HIGHWAY PLANS

PROJ. MANAGER	DESIGN-DETAILED	CHECKED-REVIEWED	DESIGNER	DATE
BY	DATE	SIGNATURE	P.E. NUMBER	DATE
DESIGNER 1	DESIGNER 2	DESIGNER 3	DESIGNER 4	DESIGNER 5
REVISIONS 1	REVISIONS 2	REVISIONS 3	REVISIONS 4	REVISIONS 5
FIELD CHANGES				

DEXTER
ROUTE 7
CROSS SECTIONS

SHEET NUMBER
120
OF 15

Date: 12/10/2013

Username: atlee.mousseau

Division: HIGHWAY

Filename: ... \121_Xsect_90+50_097.dgn

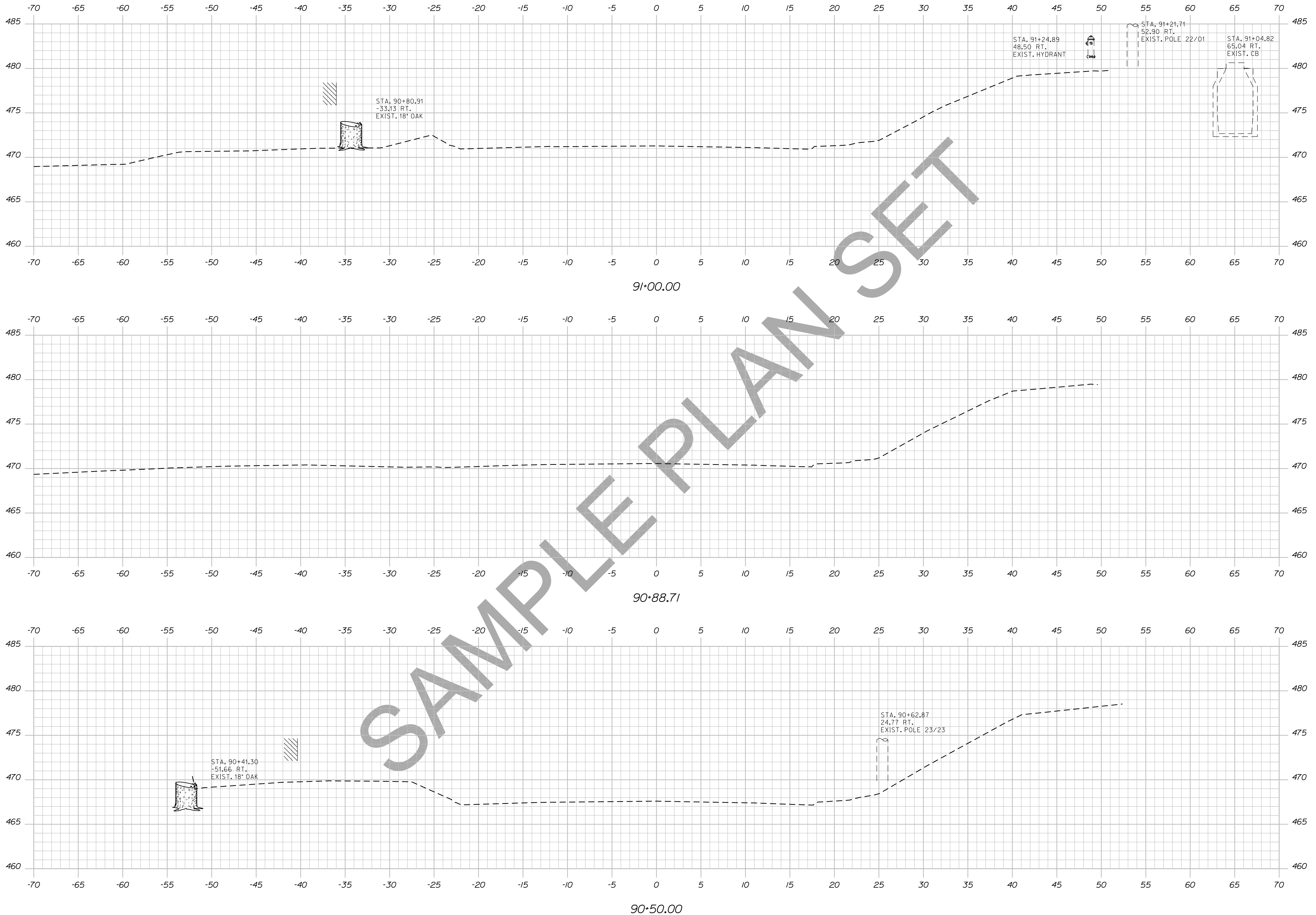

SAMPLE PLAN SET

STATE OF MAINE		DEPARTMENT OF TRANSPORTATION	
018246.00		WIN	
HIGHWAY PLANS		PIN 18246.00	
	DATE	BY	SIGNATURE
DESIGN-DETAILED	DESIGNER	DATE	SIGNATURE
CHECKED-REVIEWED	DESIGNER	DATE	SIGNATURE
DESIGNS DET AILED	DESIGNER	DATE	SIGNATURE
DESIGNS DET AILED	DESIGNER	DATE	SIGNATURE
REVISIONS 1	DESIGNER	DATE	SIGNATURE
REVISIONS 2	DESIGNER	DATE	SIGNATURE
REVISIONS 3	DESIGNER	DATE	SIGNATURE
REVISIONS 4	DESIGNER	DATE	SIGNATURE
FIELD CHANGES	DESIGNER	DATE	SIGNATURE
DEXTER ROUTE 7			
CROSS SECTIONS			
SHEET NUMBER			
121			
OF 15			

Date: 12/10/2013

Username: atlee.mousseau

Division: HIGHWAY

Filename: ... \122_Xsect_91+50_098.dgn

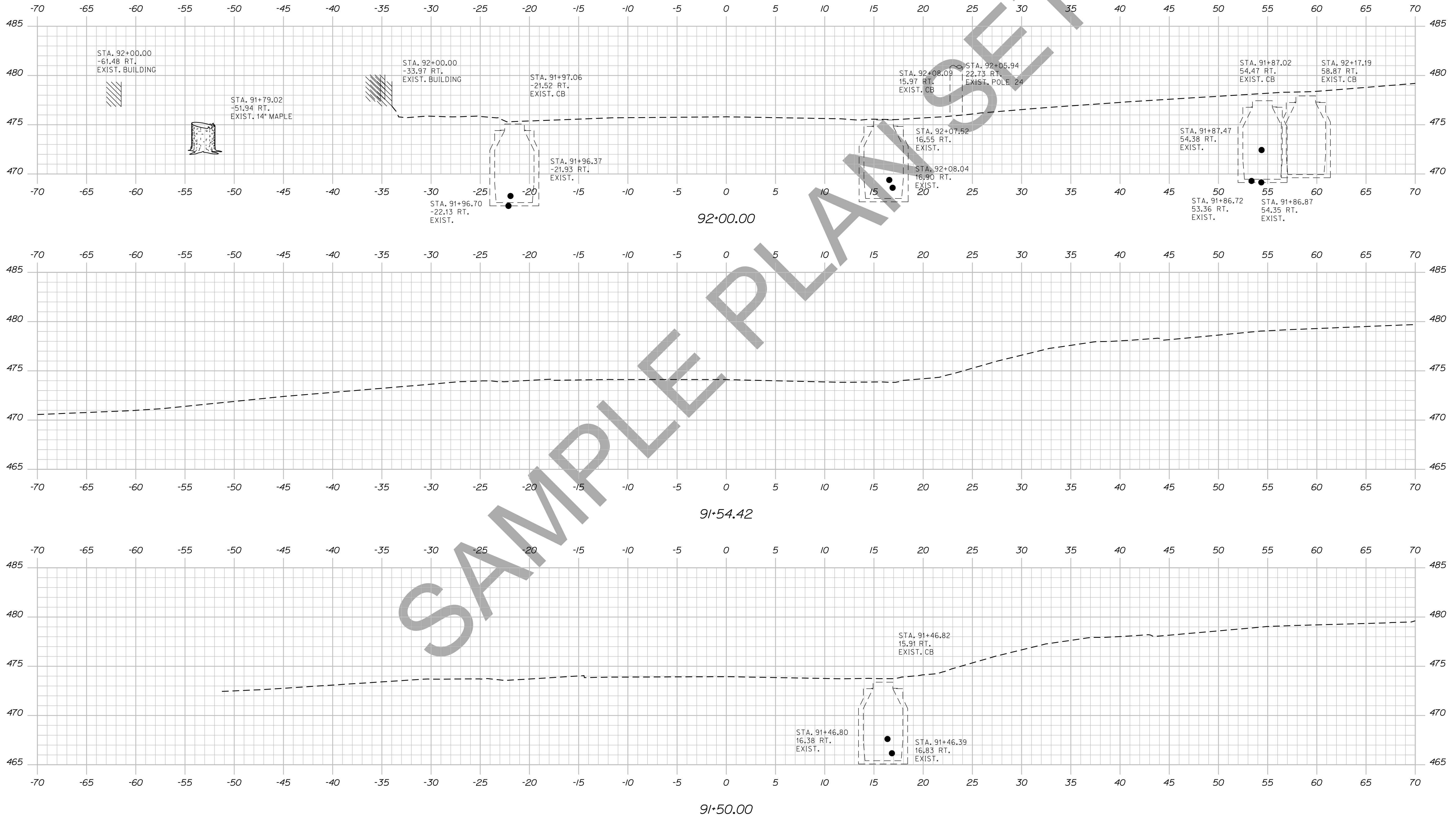

STATE OF MAINE
DEPARTMENT OF TRANSPORTATION
018246.00
WIN
PIN 18246.00
HIGHWAY PLANS

DATE	BY	PROJ. MANAGER	DESIGN DETAIL	CHECKED	DESIGN DETAIL	DESIGN DETAIL	REVISIONS 1	REVISIONS 2	REVISIONS 3	REVISIONS 4	FIELD CHANGES
SIGNATURE											
P.E. NUMBER											
DATE											

DEXTER
ROUTE 7
CROSS SECTIONS

SHEET NUMBER
122
OF 15

Date: 12/10/2013

Username: atlee.mousseau

Division: HIGHWAY

Filename: ... \123_Xsect_92+45_099.dgn

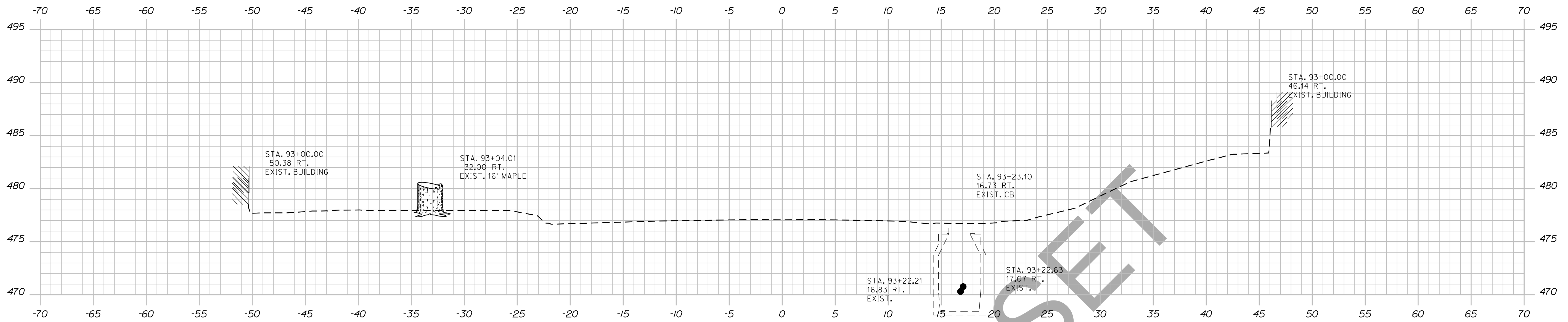

93+00.00

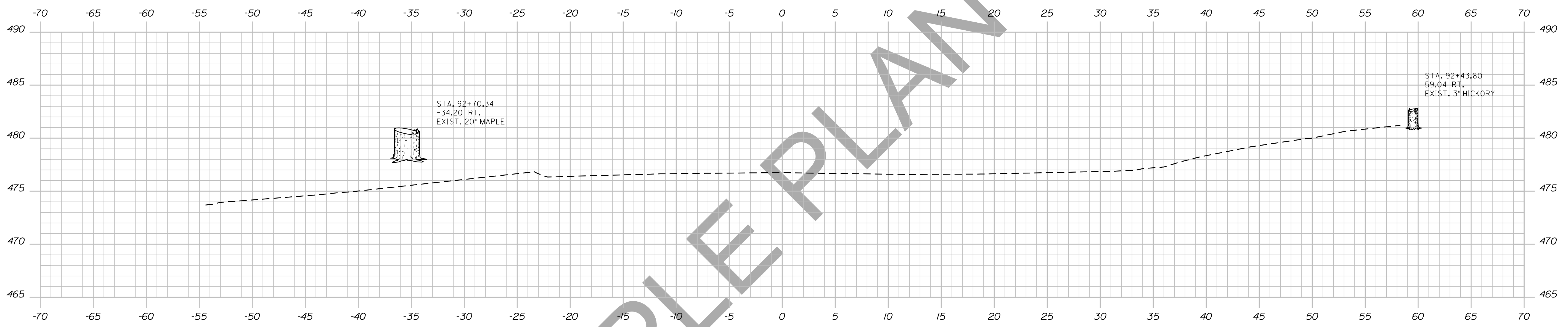

92+50.00

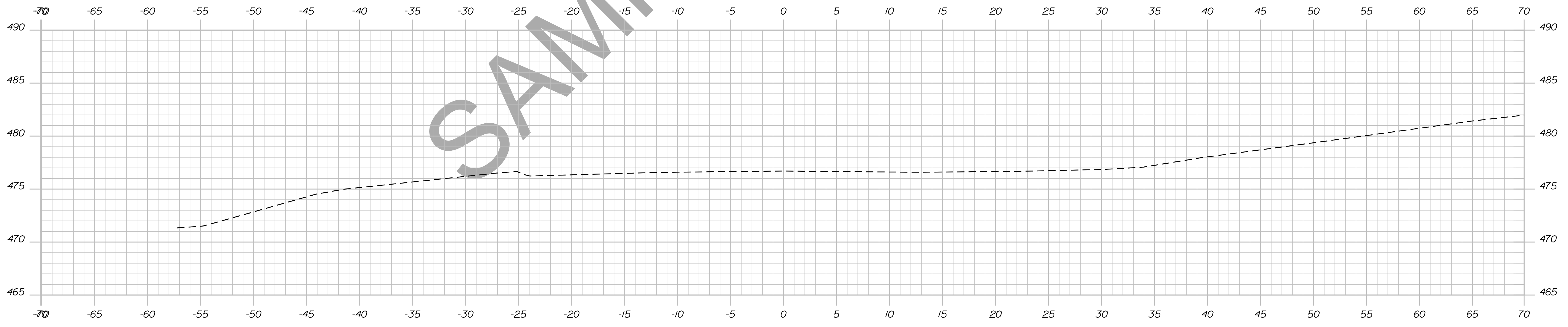

92+45.70

STATE OF MAINE
DEPARTMENT OF TRANSPORTATION
018246.00
WIN
PIN 18246.00
HIGHWAY PLANS

PROJ. MANAGER	DESIGN-DETAILED	CHECKED-REVIEWED	DESIGN-DETAILED	DESIGN-DETAILED	REVISIONS 1	REVISIONS 2	REVISIONS 3	REVISIONS 4	FIELD CHANGES	PROJ. MANAGER	BY	DATE

DEXTER
ROUTE 7
CROSS SECTIONS

SHEET NUMBER
123
OF 15

Date: 12/10/2013

Username: atlee.mousseau

Division: HIGHWAY

Filename: ... \124_Xsect_93+03_100.dgn

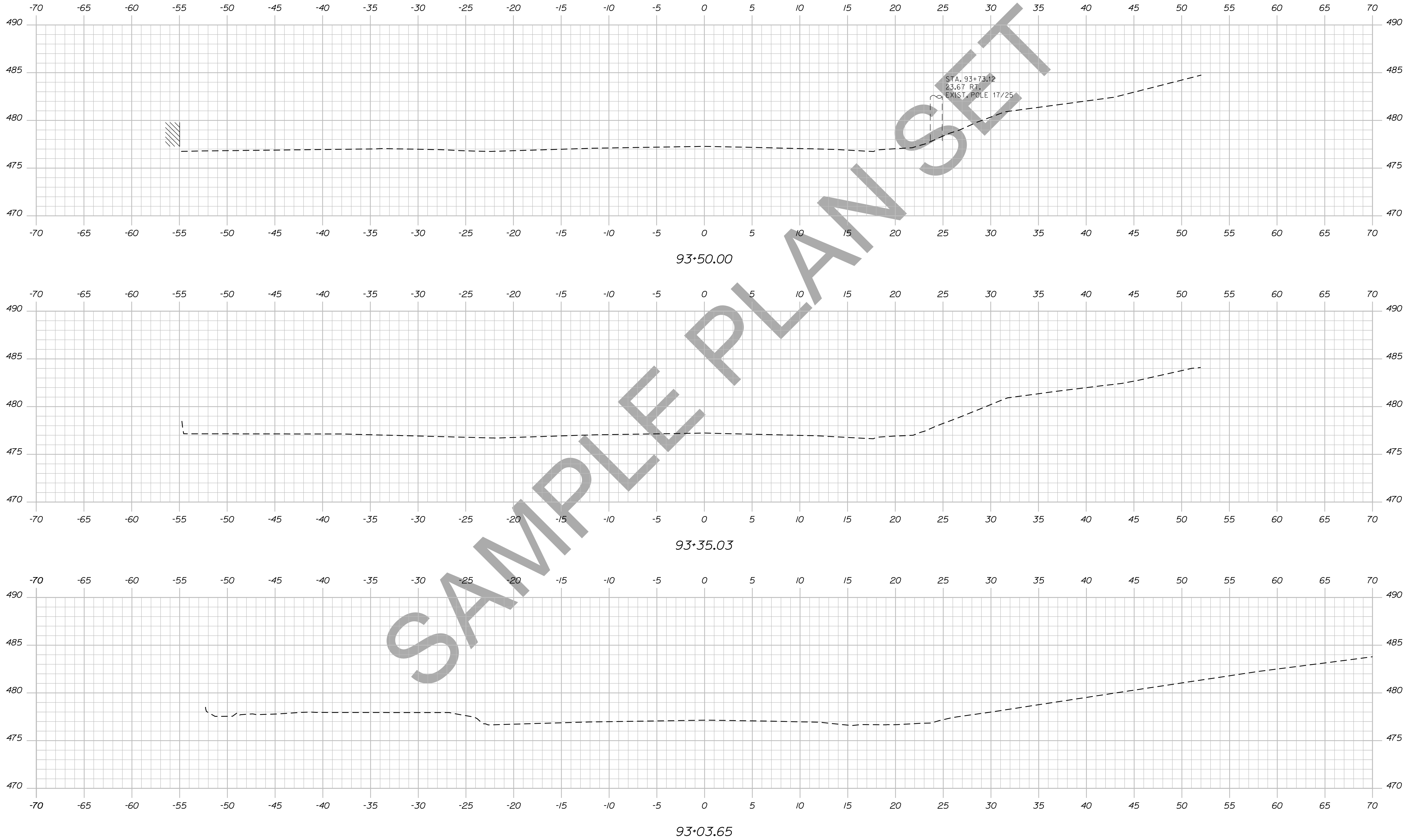

STATE OF MAINE
DEPARTMENT OF TRANSPORTATION

018246.00

WIN
PIN 18246.00

HIGHWAY PLANS

SIGNATURE

P.E. NUMBER

DATE

DATE

BY

DESIGN-DETAILED	DESIGNER	DATE
CHECKED-REVIEWED	CHECKER	DATE
DESIGN-DETAILED	DESIGNER	DATE
DESIGN-DETAILED	DESIGNER	DATE
REVISIONS 1	REVISION	DATE
REVISIONS 2	REVISION	DATE
REVISIONS 3	REVISION	DATE
REVISIONS 4	REVISION	DATE
FIELD CHANGES	FIELD	DATE

PROJ. MANAGER

PROJ. MANAGER

PROJ. MANAGER

PROJ. MANAGER

PROJ. MANAGER

PROJ. MANAGER

PROJ. MANAGER

PROJ. MANAGER

PROJ. MANAGER

PROJ. MANAGER

DEXTER
ROUTE 7

CROSS SECTIONS

SHEET NUMBER

124

OF 15

Date: 12/10/2013

Username: atlee.mousseau

Division: HIGHWAY

Filename: ... \125_Xsect_93+82_101.dgn

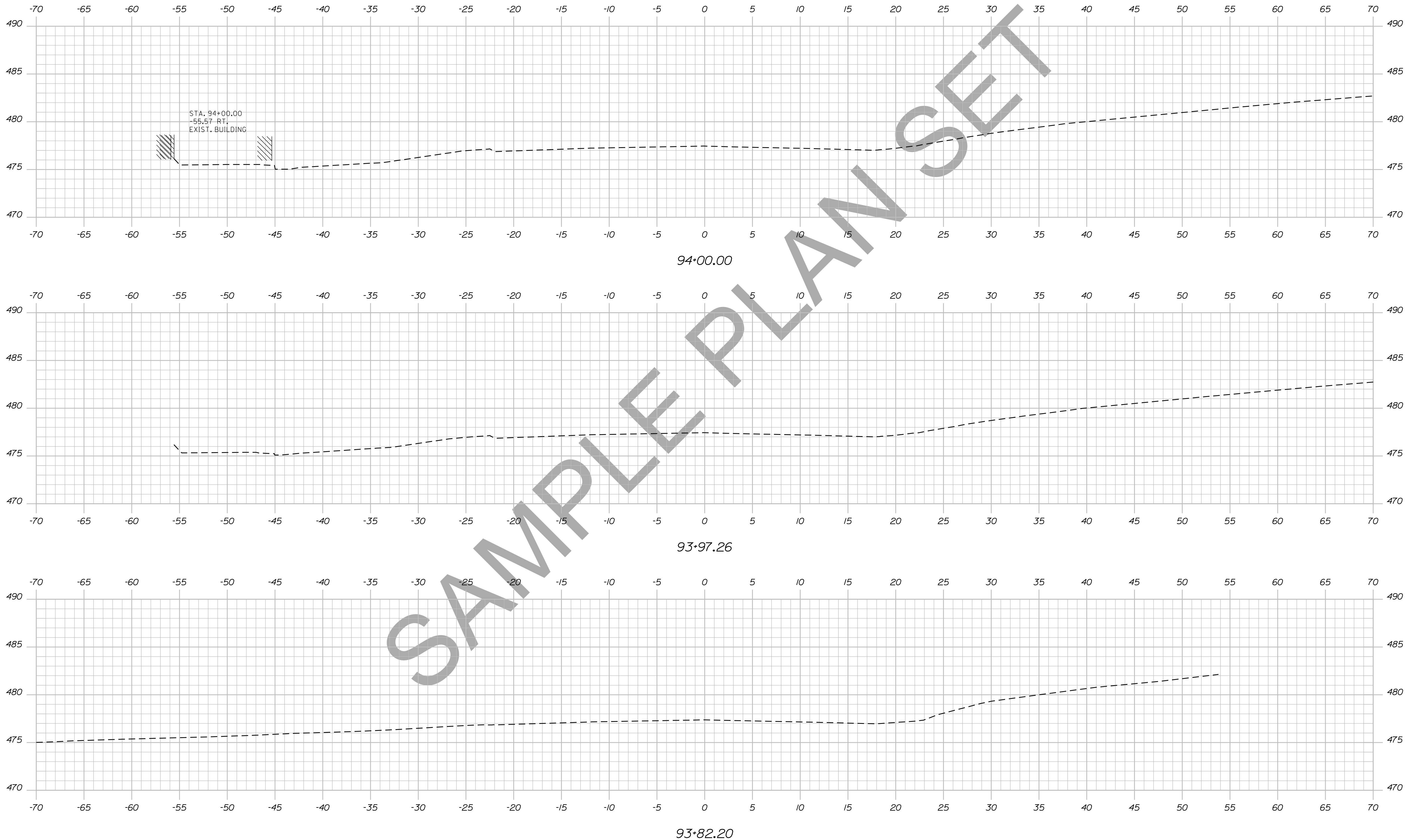

STATE OF MAINE DEPARTMENT OF TRANSPORTATION		018246.00	WIN PIN 18246.00	HIGHWAY PLANS
	SIGNATURE		P.E. NUMBER	DATE
DEXTER ROUTE 7 CROSS SECTIONS				
SHEET NUMBER				
125				
OF 15				

Date: 12/10/2013

Username: atlee.mousseau

Division: HIGHWAY

Filename: ... \126_Xsect_94+50_102.dgn

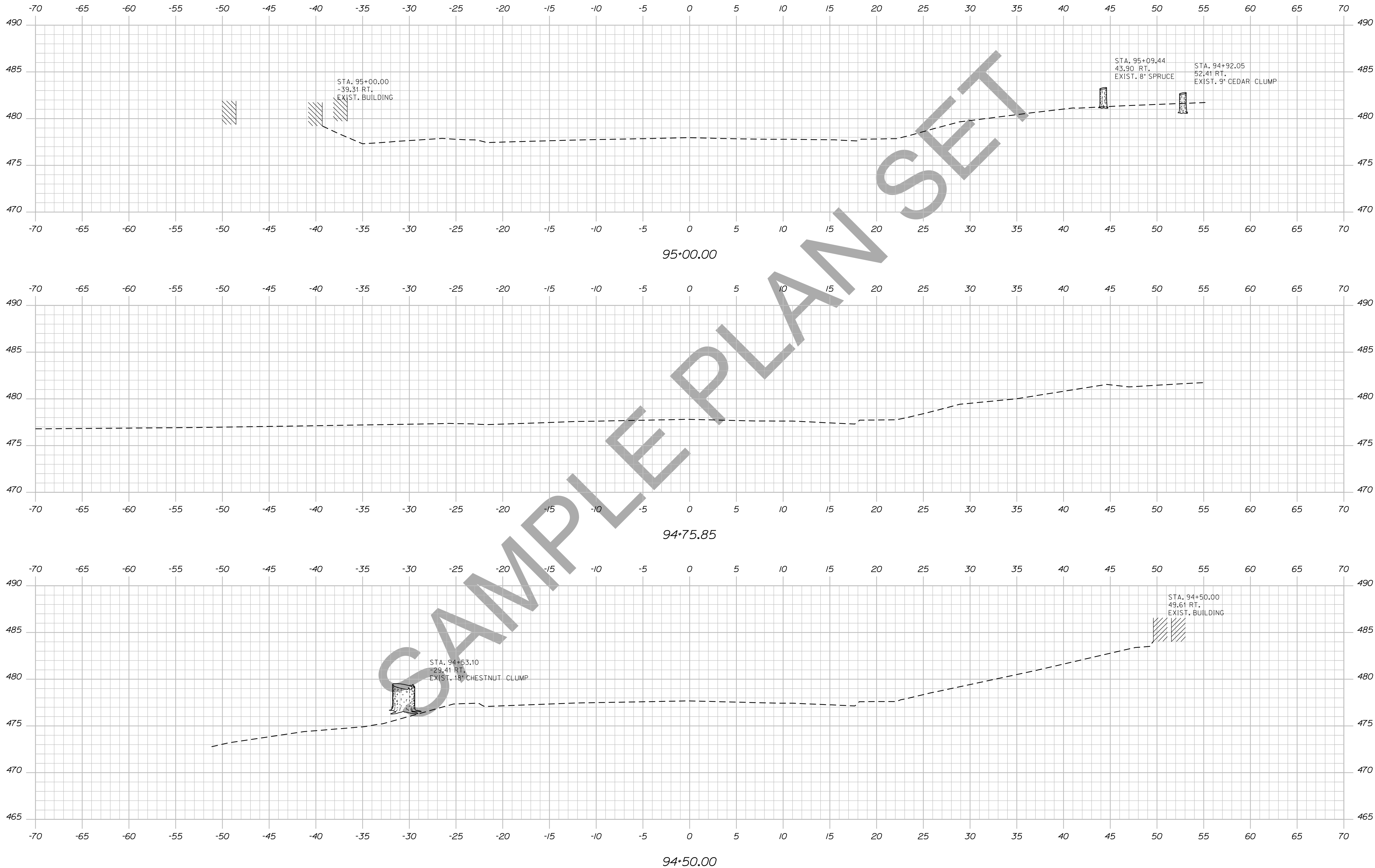

STATE OF MAINE
DEPARTMENT OF TRANSPORTATION

018246.00

WIN
PIN 18246.00

HIGHWAY PLANS

PROJ. MANAGER	BY	DATE	SIGNATURE	P.E. NUMBER	DATE
DESIGN-DETAILED	DESIGNER	DATE			
CHECKED-REVIEWED	CHECKER	DATE			
DESIGN-DETAILED	DESIGNER	DATE			
DESIGN-DETAILED	DESIGNER	DATE			
REVISIONS 1					
REVISIONS 2					
REVISIONS 3					
REVISIONS 4					
FIELD CHANGES					

DEXTER
ROUTE 7
CROSS SECTIONS

SHEET NUMBER

126

OF 15

Sta. 94+50.00 to Sta. 95+00.00

Date: 12/10/2013

Username: atlee.mousseau

Division: HIGHWAY

Filename: ... \127_Xsect_95+14_103.dgn

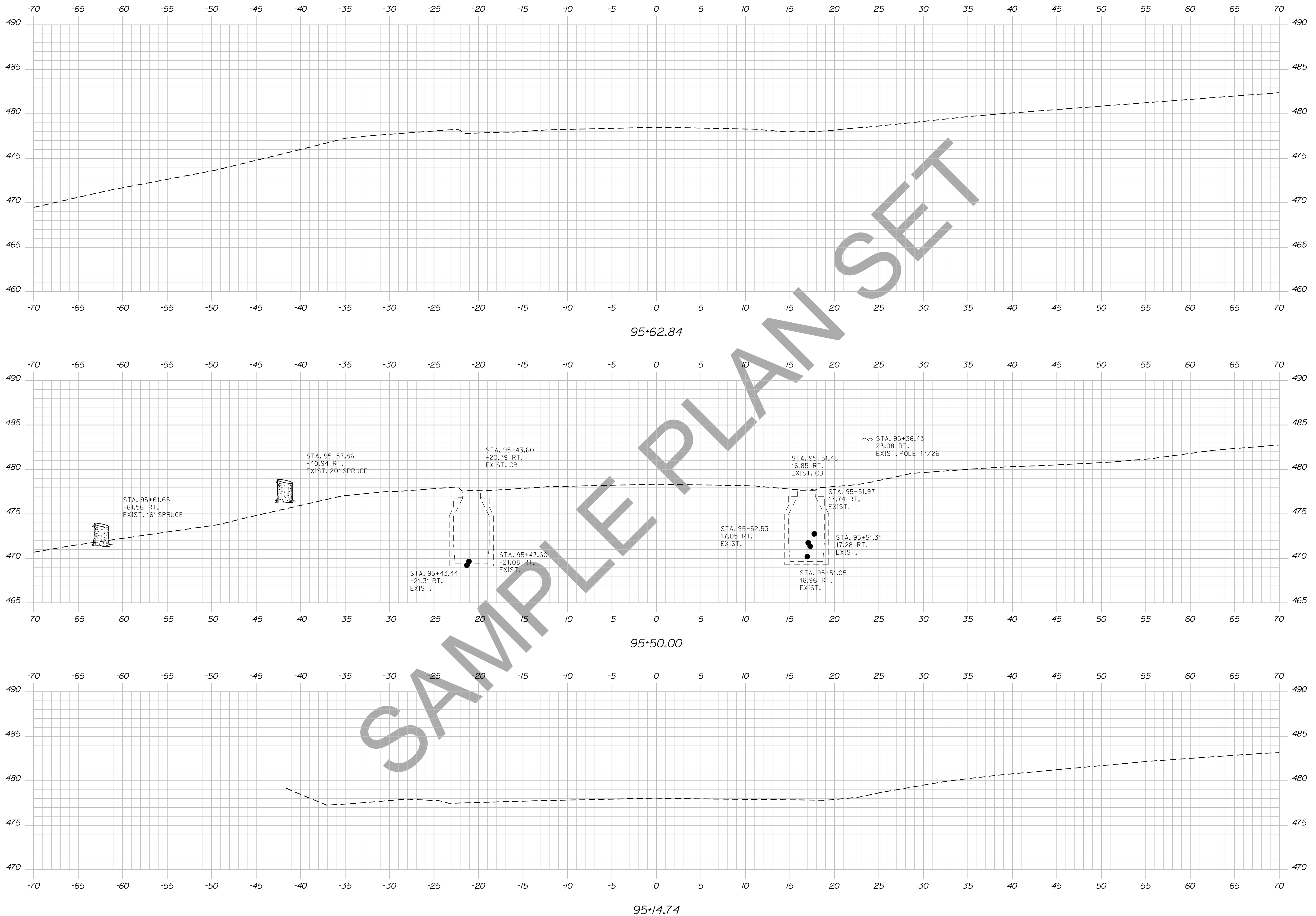

STATE OF MAINE
DEPARTMENT OF TRANSPORTATION
018246.00
WIN
PIN 18246.00
HIGHWAY PLANS

PROJ. MANAGER	BY	DATE	SIGNATURE
DESIGN-DETAILED	DESIGNER	DATE	SIGNATURE
CHECKED-REVIEWED	CHECKER	DATE	SIGNATURE
DESIGNS-DETAILED	DESIGNER	DATE	SIGNATURE
DESIGNS-DETAILED	DESIGNER	DATE	SIGNATURE
REVISIONS 1	REVISION	DATE	P.E. NUMBER
REVISIONS 2	REVISION	DATE	P.E. NUMBER
REVISIONS 3	REVISION	DATE	P.E. NUMBER
REVISIONS 4	REVISION	DATE	P.E. NUMBER
FIELD CHANGES	FIELD	DATE	P.E. NUMBER

DEXTER
ROUTE 7
CROSS SECTIONS

SHEET NUMBER
127
OF 15

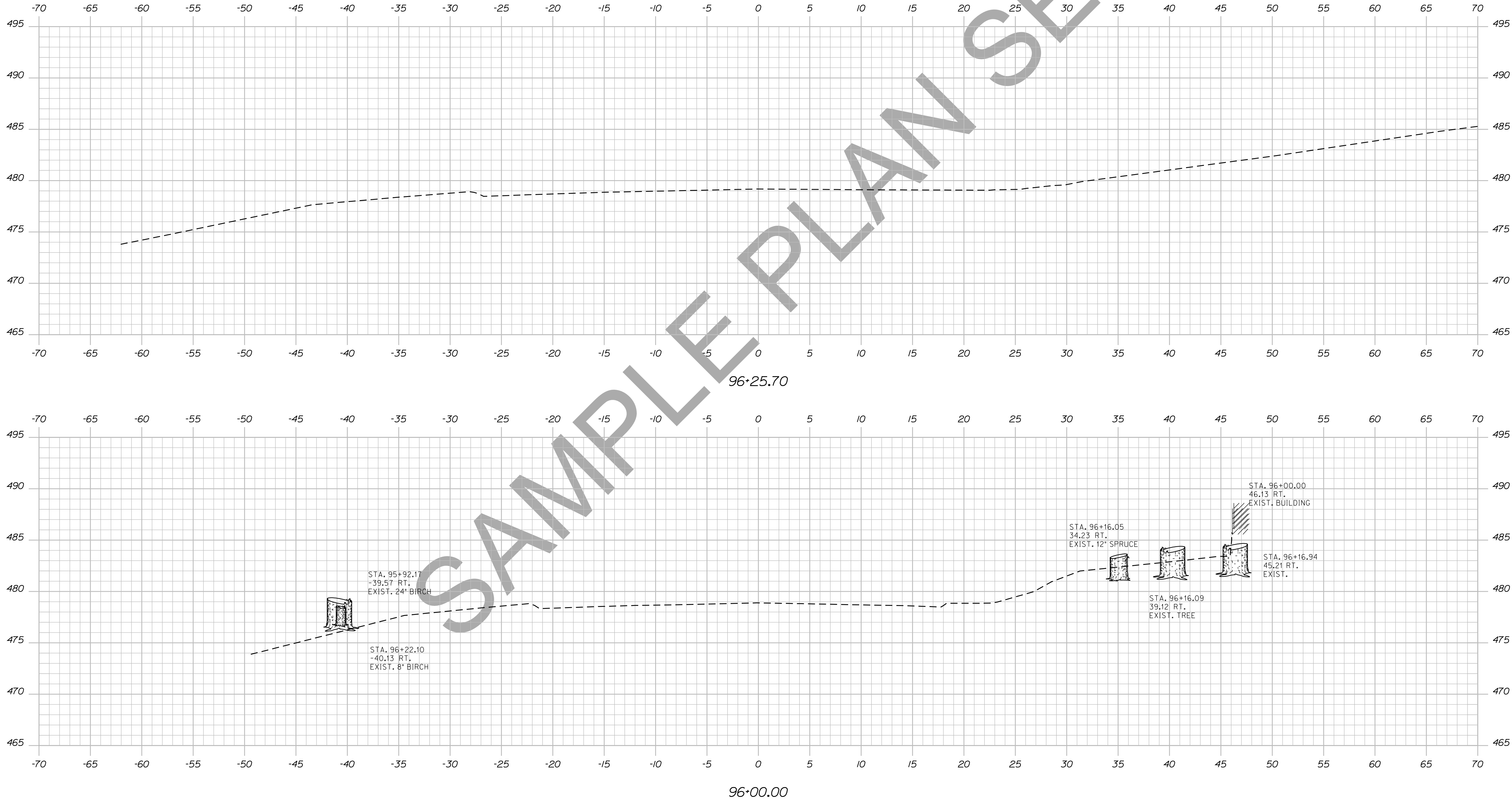

STATE OF MAINE
DEPARTMENT OF TRANSPORTATION
018246.00
WIN
PIN 18246.00
HIGHWAY PLANS

PROJ. MANAGER	DESIGN-DETAILED	CHECKED-REVIEWED	DESIGN-DET. TAILED	DESIGN-DET. TAILED	REVISIONS 1	REVISIONS 2	REVISIONS 3	REVISIONS 4	FIELD CHANGES	BY	DATE	SIGNATURE	P.E. NUMBER	DATE

DEXTER
ROUTE 7
CROSS SECTIONS

SHEET NUMBER
128
OF 15

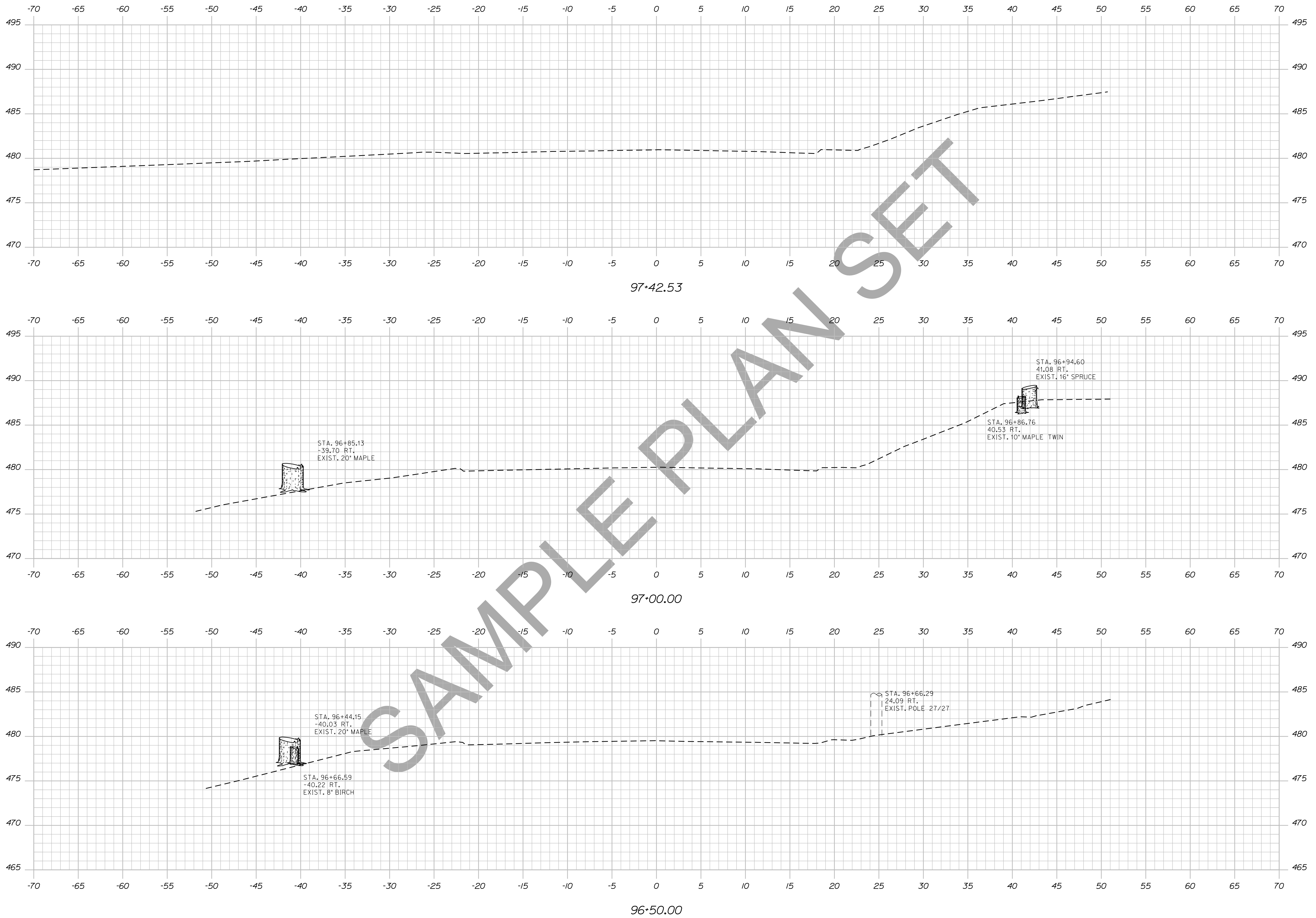

STATE OF MAINE
DEPARTMENT OF TRANSPORTATION

018246.00

WIN
PIN 18246.00

HIGHWAY PLANS

PROJ. MANAGER	DESIGN-DETAILED	CHECKED-REVIEWED	DESIGN-DETAILED	CHECKED-REVIEWED	DESIGN-DETAILED	CHECKED-REVIEWED	DATE
\$ProjMgr1\$	\$Designer1\$	\$Checker1\$	\$ProjMgr2\$	\$Designer2\$	\$Checker2\$	\$ProjMgr3\$	\$Date1\$
\$ProjMgr4\$	\$Designer4\$	\$Checker4\$	\$ProjMgr5\$	\$Designer5\$	\$Checker5\$	\$ProjMgr6\$	\$Date2\$
\$ProjMgr7\$	\$Designer7\$	\$Checker7\$	\$ProjMgr8\$	\$Designer8\$	\$Checker8\$	\$ProjMgr9\$	\$Date3\$
\$ProjMgr10\$	\$Designer10\$	\$Checker10\$	\$ProjMgr11\$	\$Designer11\$	\$Checker11\$	\$ProjMgr12\$	\$Date4\$
\$ProjMgr13\$	\$Designer13\$	\$Checker13\$	\$ProjMgr14\$	\$Designer14\$	\$Checker14\$	\$ProjMgr15\$	\$Date5\$
\$ProjMgr16\$	\$Designer16\$	\$Checker16\$	\$ProjMgr17\$	\$Designer17\$	\$Checker17\$	\$ProjMgr18\$	\$Date6\$
\$ProjMgr19\$	\$Designer19\$	\$Checker19\$	\$ProjMgr20\$	\$Designer20\$	\$Checker20\$	\$ProjMgr21\$	\$Date7\$

SIGNATURE

P.E. NUMBER

DATE

DEXTER
ROUTE 7

CROSS SECTIONS

SHEET NUMBER

129

OF 15

Date: 12/10/2013

Username: atlee.mousseau

Division: HIGHWAY

Filename: ... \130_Xsect_97+50_106.dgn

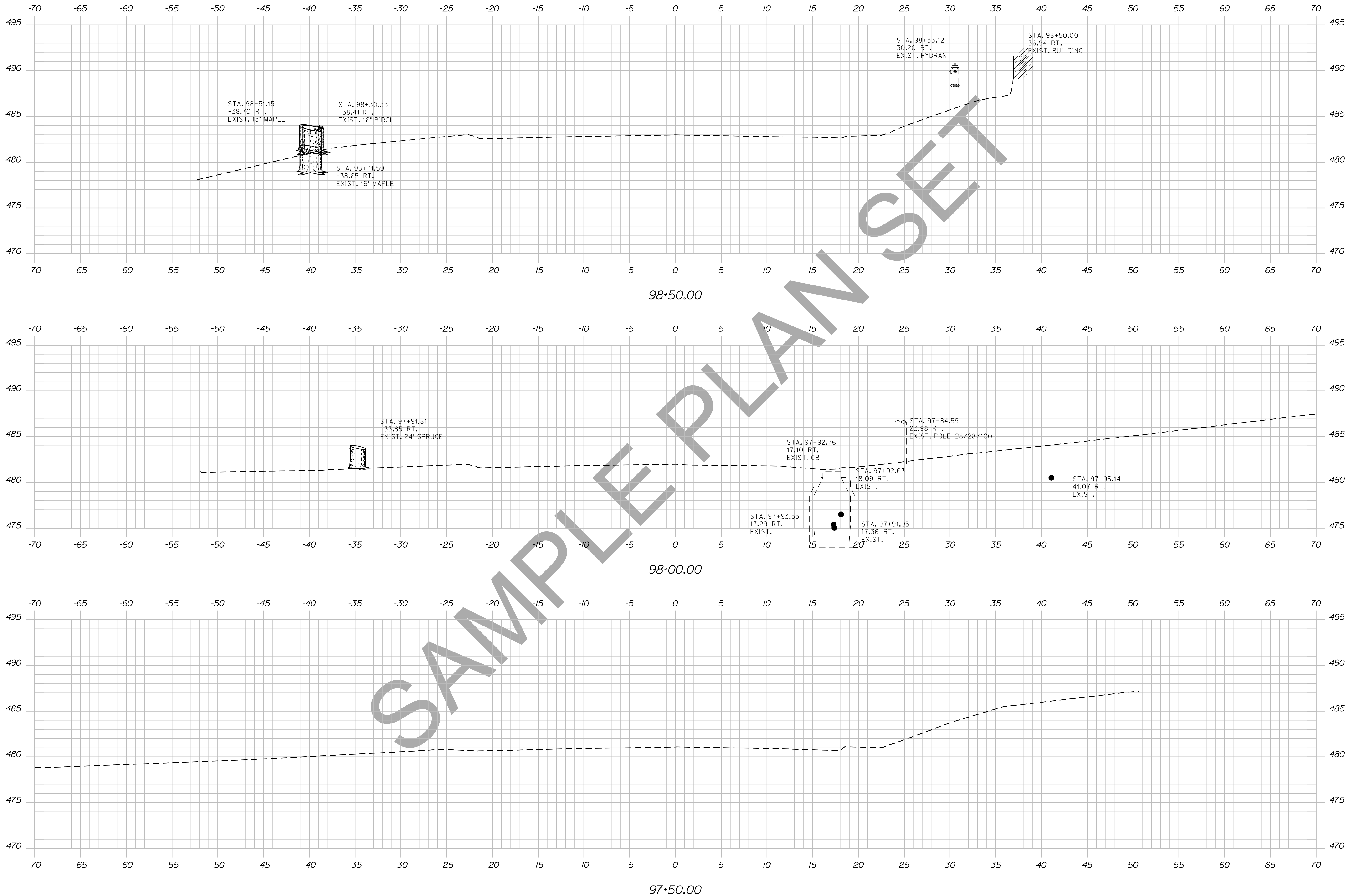

SAMPLE PLAN SET

STATE OF MAINE
DEPARTMENT OF TRANSPORTATION
018246.00
WIN
PIN 18246.00
HIGHWAY PLANS

PROJ. MANAGER	DESIGN-DETAILED	CHECKED-REVIEWED	DESIGN-DETAILED	DESIGN-DETAILED	REVISIONS 1	REVISIONS 2	REVISIONS 3	REVISIONS 4	FIELD CHANGES

DATE	SIGNATURE	P.E. NUMBER	DATE

DEXTER
ROUTE 7
CROSS SECTIONS

SHEET NUMBER
130
OF 15

Filename: ... \131_Xsect_99+00_107.dgn

Division: HIGHWAY

Username: atlee.mousseau

Date: 12/10/2013

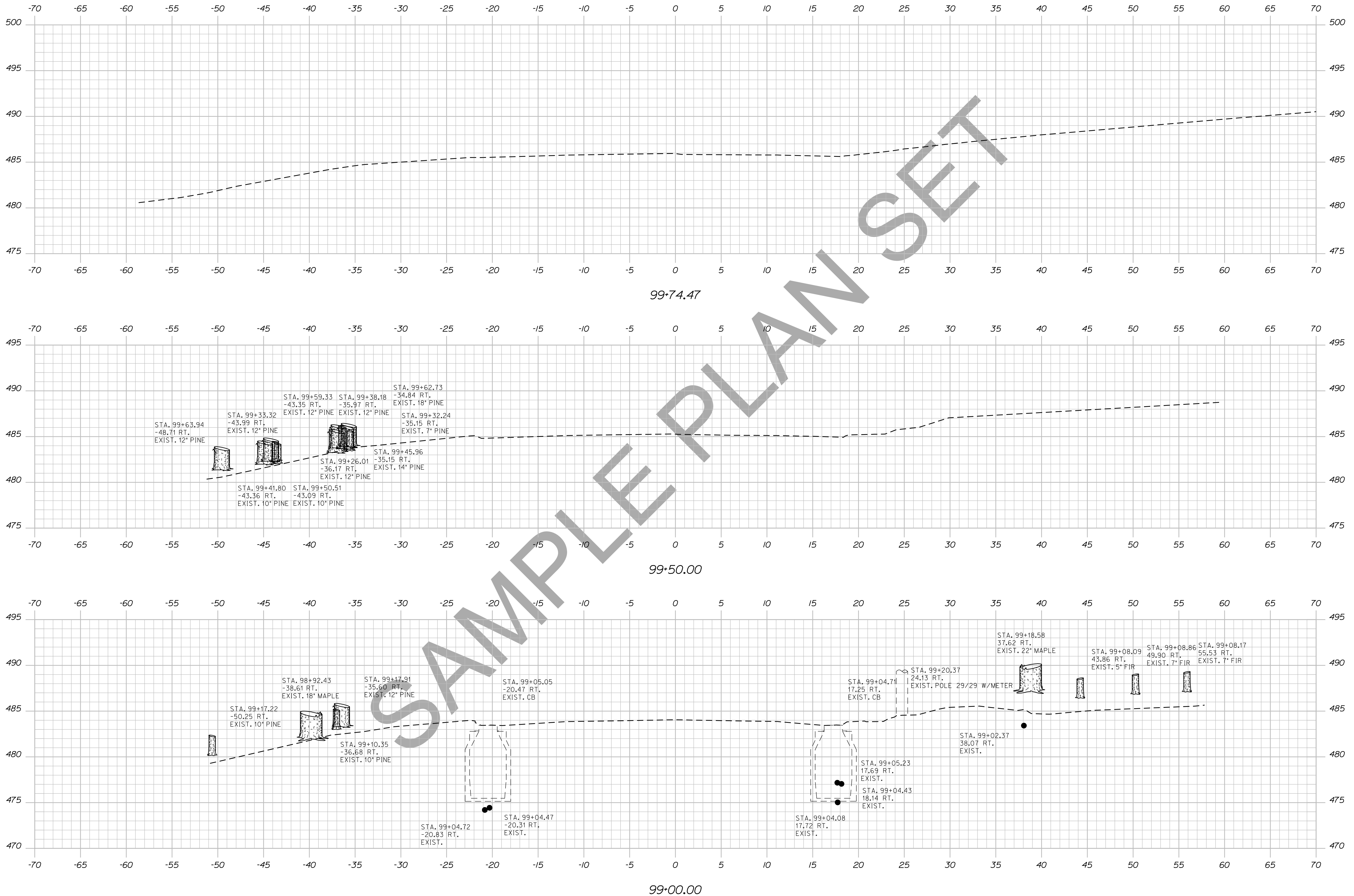

STATE OF MAINE
DEPARTMENT OF TRANSPORTATION
018246.00
WIN
PIN 18246.00
HIGHWAY PLANS

PROJ. MANAGER	BY	DATE	SIGNATURE	P.E. NUMBER	DATE
DESIGN-DETAILED	DESIGNER	DATE			
CHECKED-REVIEWED	CHECKER	DATE			
DESIGNS DET. AIDED	DESIGNER	DATE			
DESIGNS DET. AIDED	DESIGNER	DATE			
REVISIONS 1					
REVISIONS 2					
REVISIONS 3					
REVISIONS 4					
FIELD CHANGES					

DEXTER
ROUTE 7
CROSS SECTIONS

SHEET NUMBER
131
OF 15

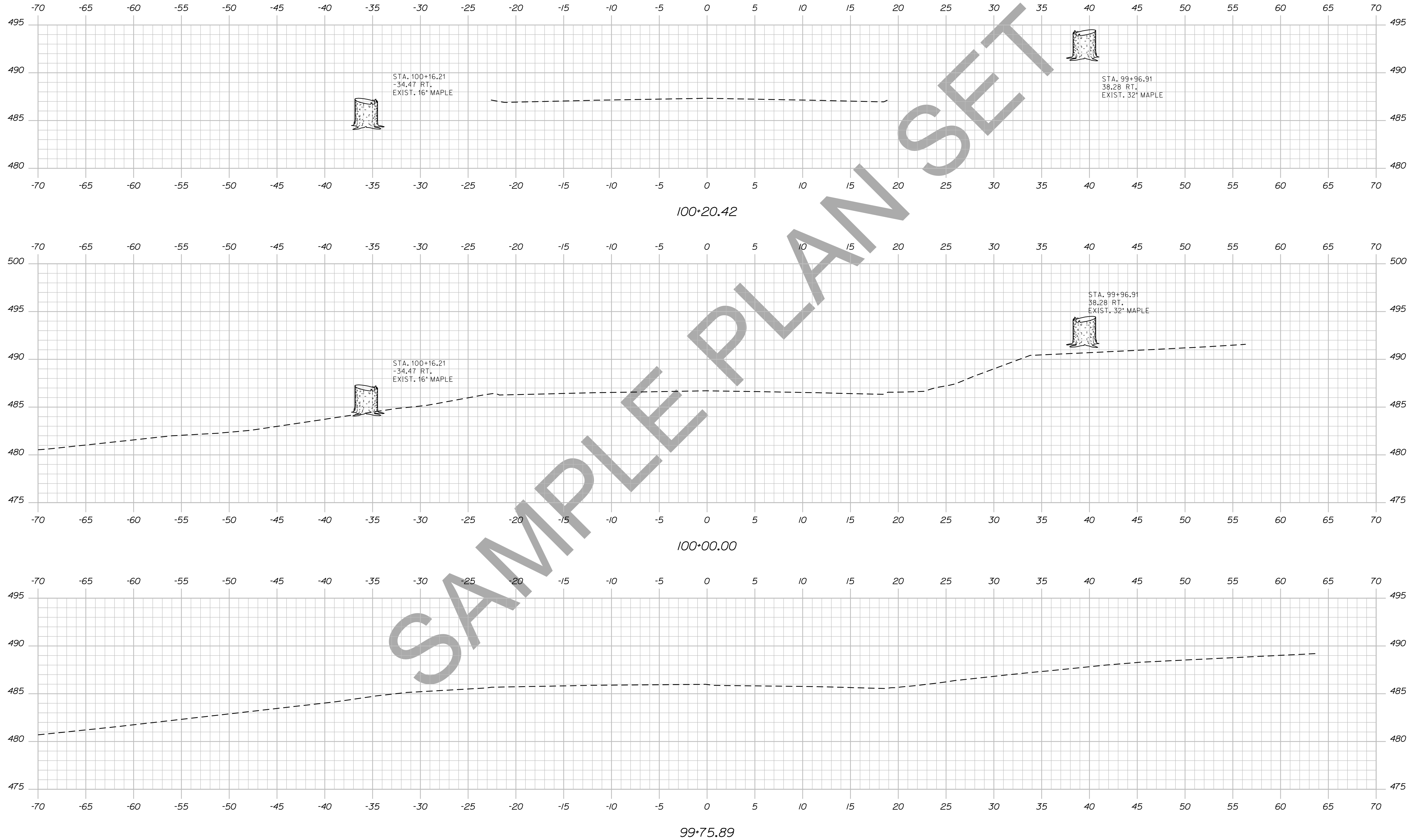

STATE OF MAINE
DEPARTMENT OF TRANSPORTATION
018246.00
WIN
PIN 18246.00
HIGHWAY PLANS

SIGNATURE
P.E. NUMBER
DATE

PROJ. MANAGER	DESIGNER	CHECKED	DATE

DEXTER
ROUTE 7
CROSS SECTIONS

SHEET NUMBER
132
OF 15